

PLAN
SCALE 1:1000

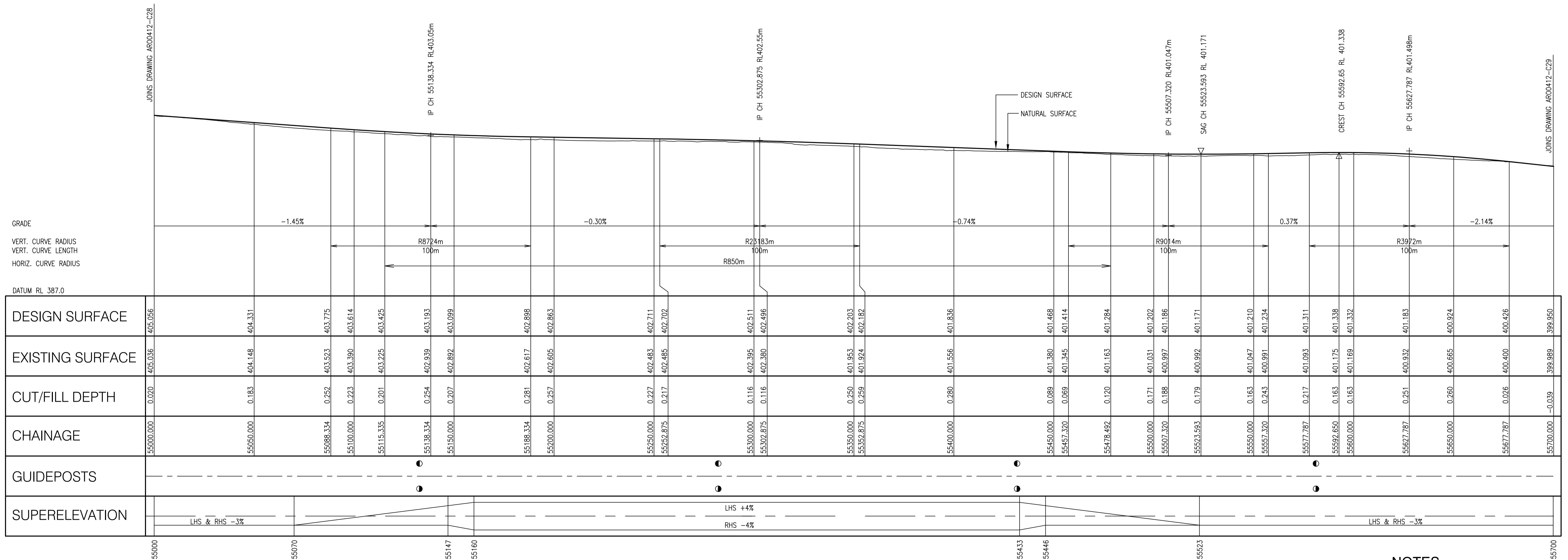

DESIGN CONTROL LINE LONGITUDINAL SECTION
SCALE 1:1000 HOR, 1:200 VERT

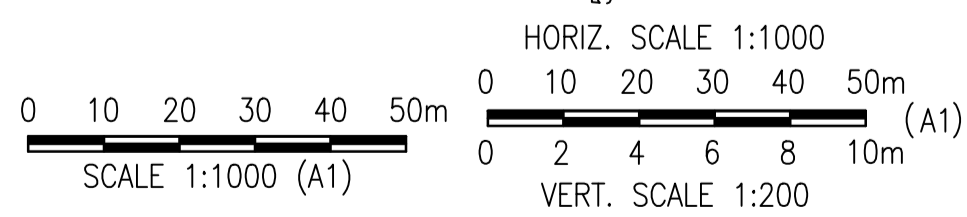

NOTES

- REFER TO DRAWING ARO0412-C49 FOR LEGEND AND ARO0412-C01 FOR NOTES.

TENDER ISSUE ONLY

No.	Description	Reviewed	Approved	Date
1	TENDER ISSUE ONLY	-	-	23/08/2024



Client	BANANA SHIRE COUNCIL
Project	DEFENCE ROAD UPGRADE - CH 36,172 - CH68,499
Title	WORKING PLAN - SHEET 28 OF 47

Drawn	MS	Designed	MS	Approved	
Drawing Check		Design Check		RPEQ	Date
Scale (A1 size)			AS SHOWN		
Drawing is not to be used for construction unless approved.					

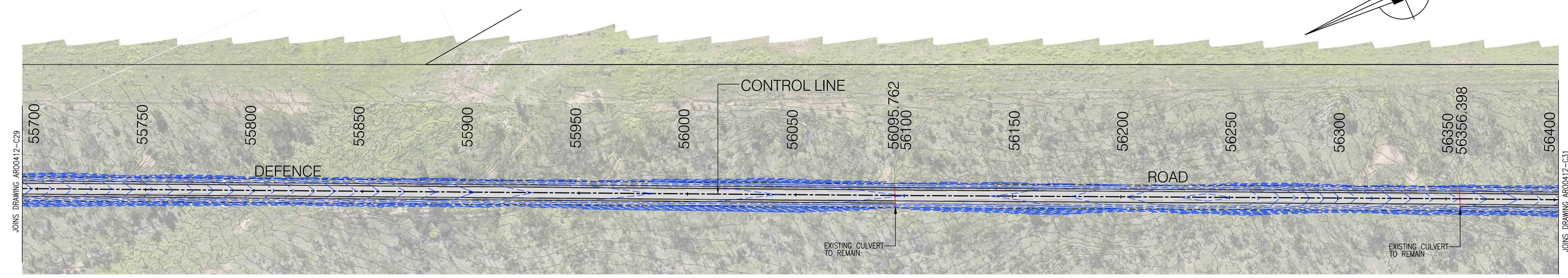
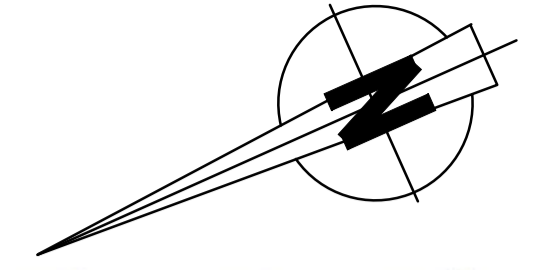

PLAN
SCALE 1:1000

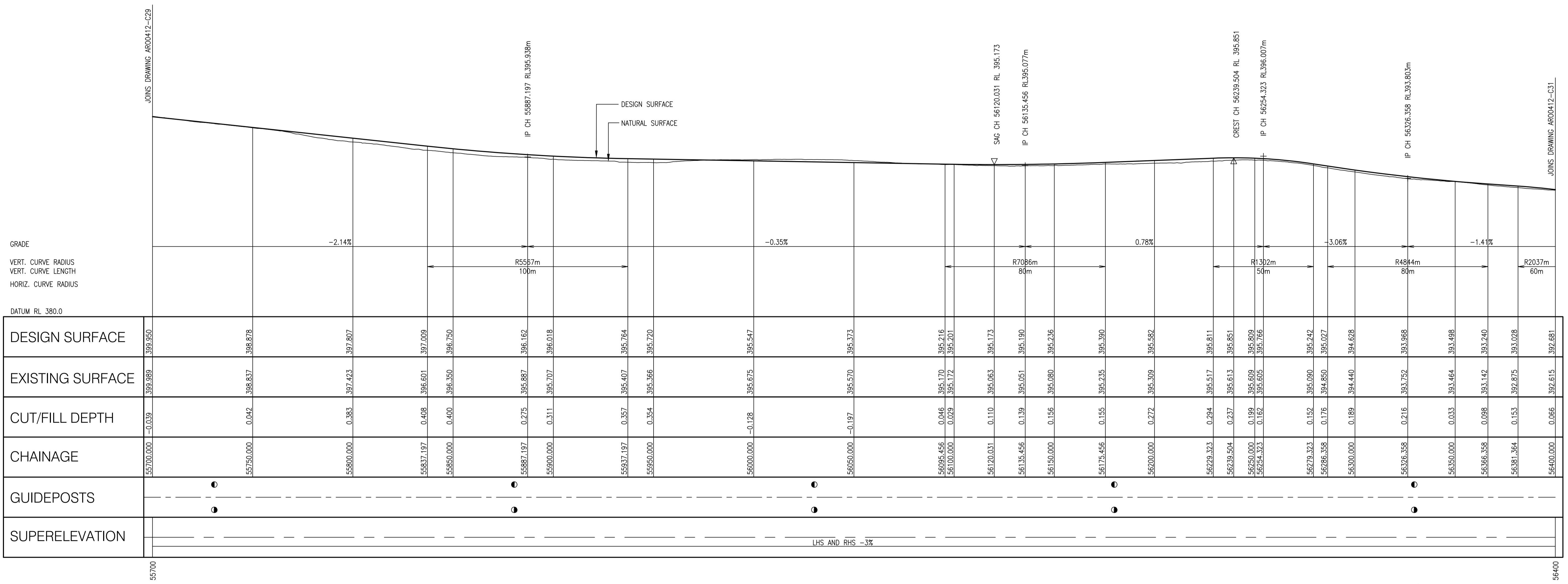

DESIGN CONTROL LINE LONGITUDINAL SECTION
SCALE 1:1000 HOR, 1:200 VERT

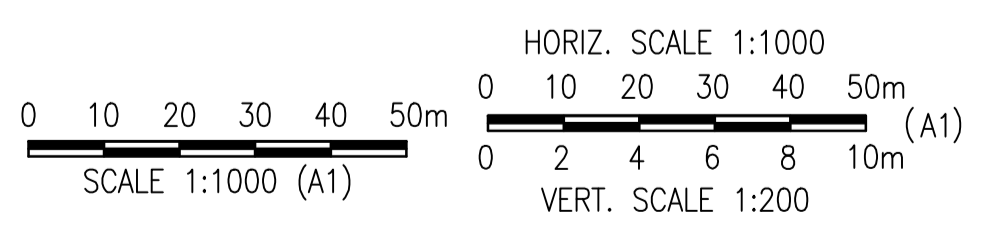

NOTES
1. REFER TO DRAWING ARO0412-C49 FOR LEGEND AND ARO0412-C01 FOR NOTES.

TENDER ISSUE ONLY

No.	Description	Reviewed	Approved	Date
1	TENDER ISSUE ONLY	-	-	23/08/2024



Client: BANANA SHIRE COUNCIL
Project: DEFENCE ROAD UPGRADE - CH 36,172 - CH68,499
Title: WORKING PLAN - SHEET 29 OF 47

Drawn	Designed	Approved	Scale (A1 size)
MS	MS		AS SHOWN
Drawing Check	Design Check	RPEQ	Date

Drawing is not to be used for construction unless approved.

51 Sheridan Street
Cairns Qld 4870
T (07) 4281 6897
E admin@arindustries.com.au
W www.arindustries.com.au
ABN: 49 641 461 298

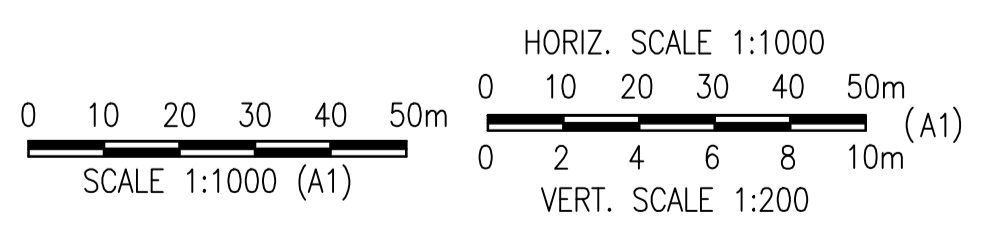
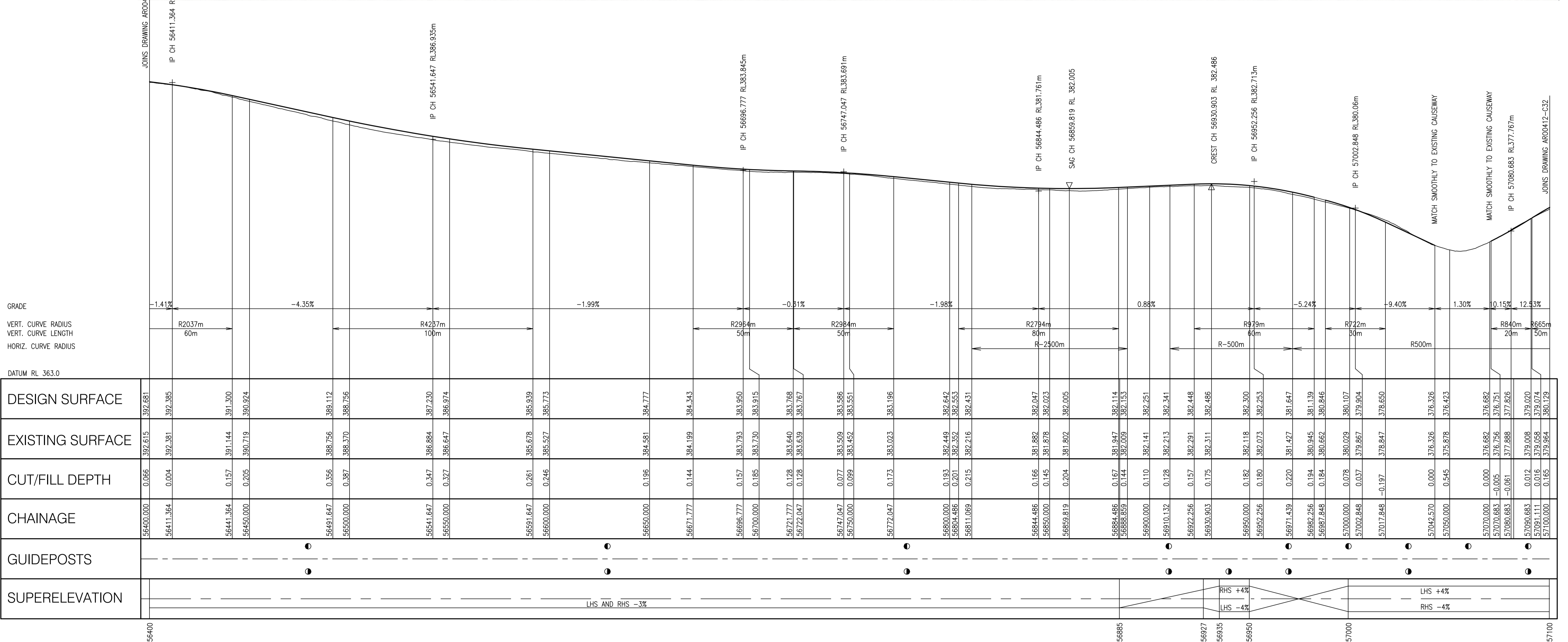
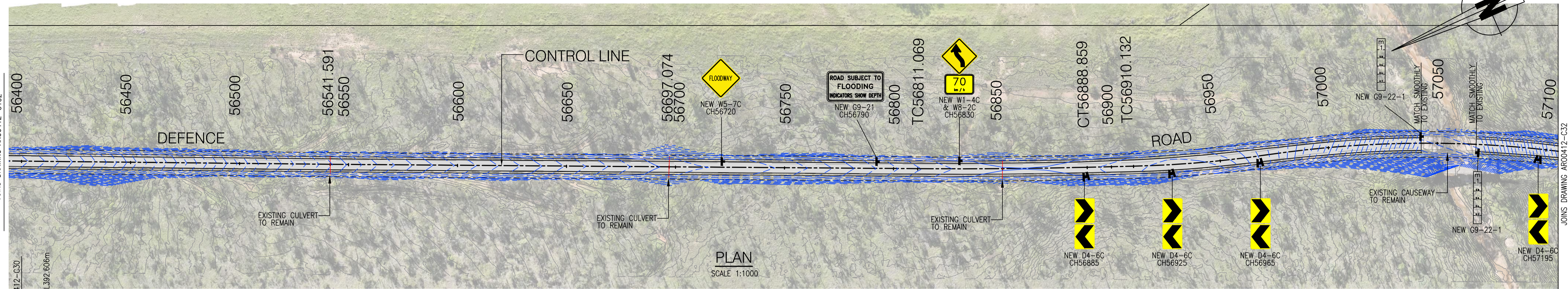

NOTES
1. REFER TO DRAWING ARO0412-C49 FOR LEGEND AND ARO0412-C01 FOR NOTES.

TENDER ISSUE ONLY

No.	Description	Reviewed	Approved	Date
1	TENDER ISSUE ONLY			23/08/2024



Client: BANANA SHIRE COUNCIL
Project: DEFENCE ROAD UPGRADE - CH 36,172 - CH68,499
Title: WORKING PLAN - SHEET 30 OF 47

Drawn	Designed	Approved	Scale (A1 size)
MS	MS		AS SHOWN
Drawing Check	Design Check	RPEQ	Date

51 Sheridan Street
Cairns Qld 4870
T (07) 4281 6897
E admin@aroindustries.com.au
W www.aroindustries.com.au
ABN: 49 641 461 298

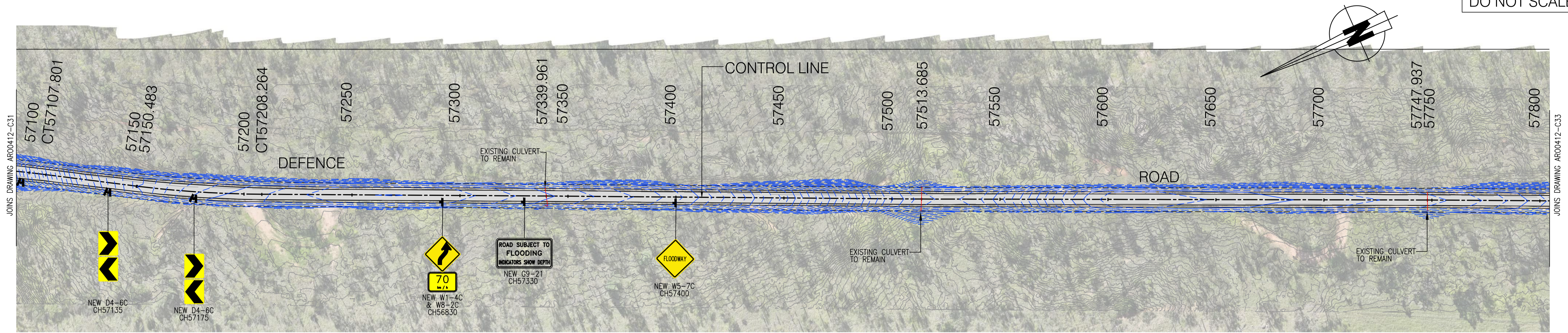

PLAN
SCALE 1:1000

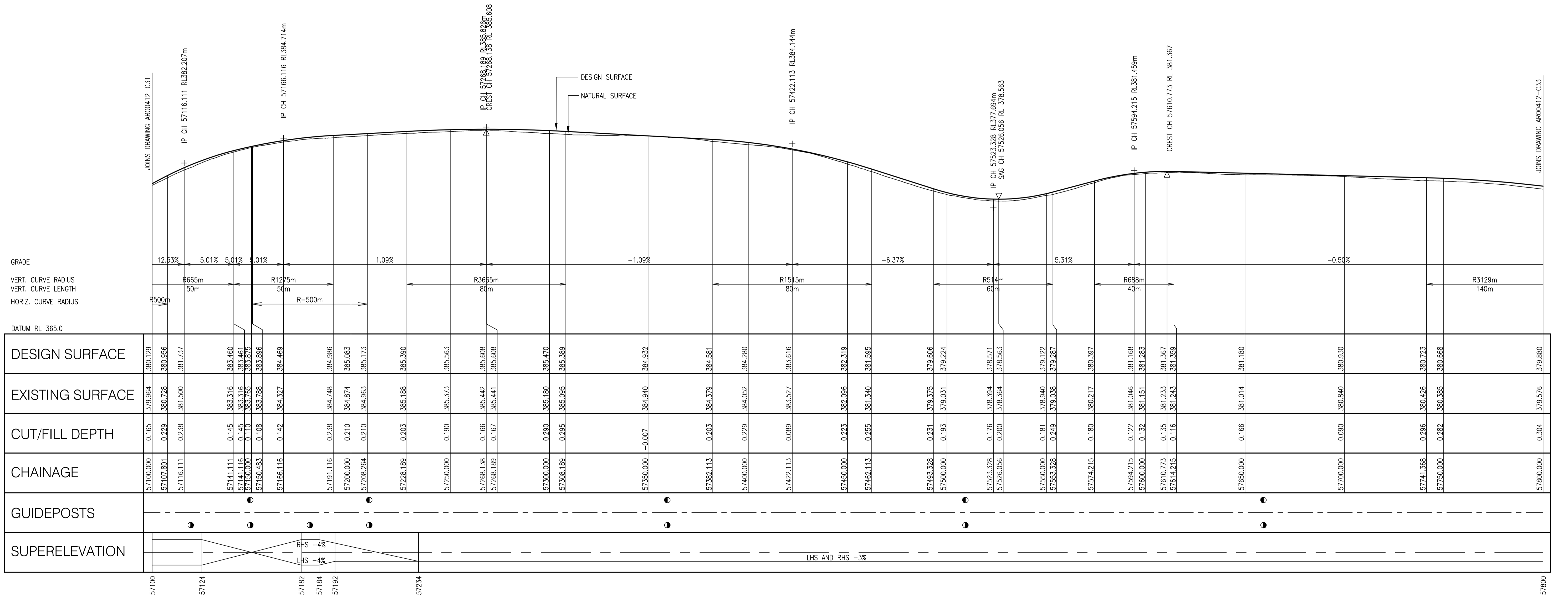

DESIGN CONTROL LINE LONGITUDINAL SECTION
SCALE 1:1000 HOR, 1:200 VERT

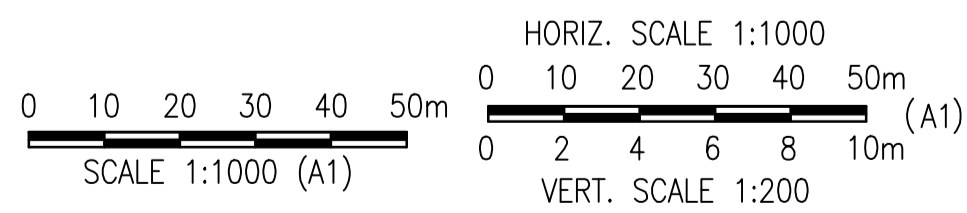

NOTES

- REFER TO DRAWING ARO0412-C49 FOR LEGEND AND ARO0412-C01 FOR NOTES.

TENDER ISSUE ONLY

No.	Description	Reviewed	Approved	Date
1	TENDER ISSUE ONLY	-	-	23/08/2024



Client	BANANA SHIRE COUNCIL
Project	DEFENCE ROAD UPGRADE - CH 36,172 - CH68,499
Title	WORKING PLAN - SHEET 31 OF 47

Drawn	MS	Designed	MS	Approved	
Drawing Check		Design Check		RPEQ	Date

Scale (A1 size)
AS SHOWN

Drawing is not to be used for construction unless approved.

51 Sheridan Street
Cairns Qld 4870
T (07) 4281 6897
E admin@aroindustries.com.au
W www.aroindustries.com.au
ABN: 49 641 461 298

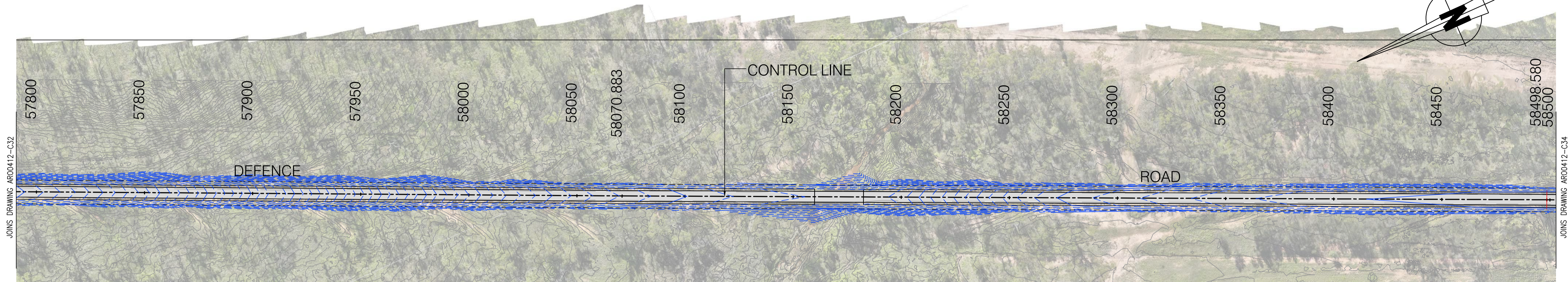

PLAN
SCALE 1:1000

Note: Limit of works CH58,184

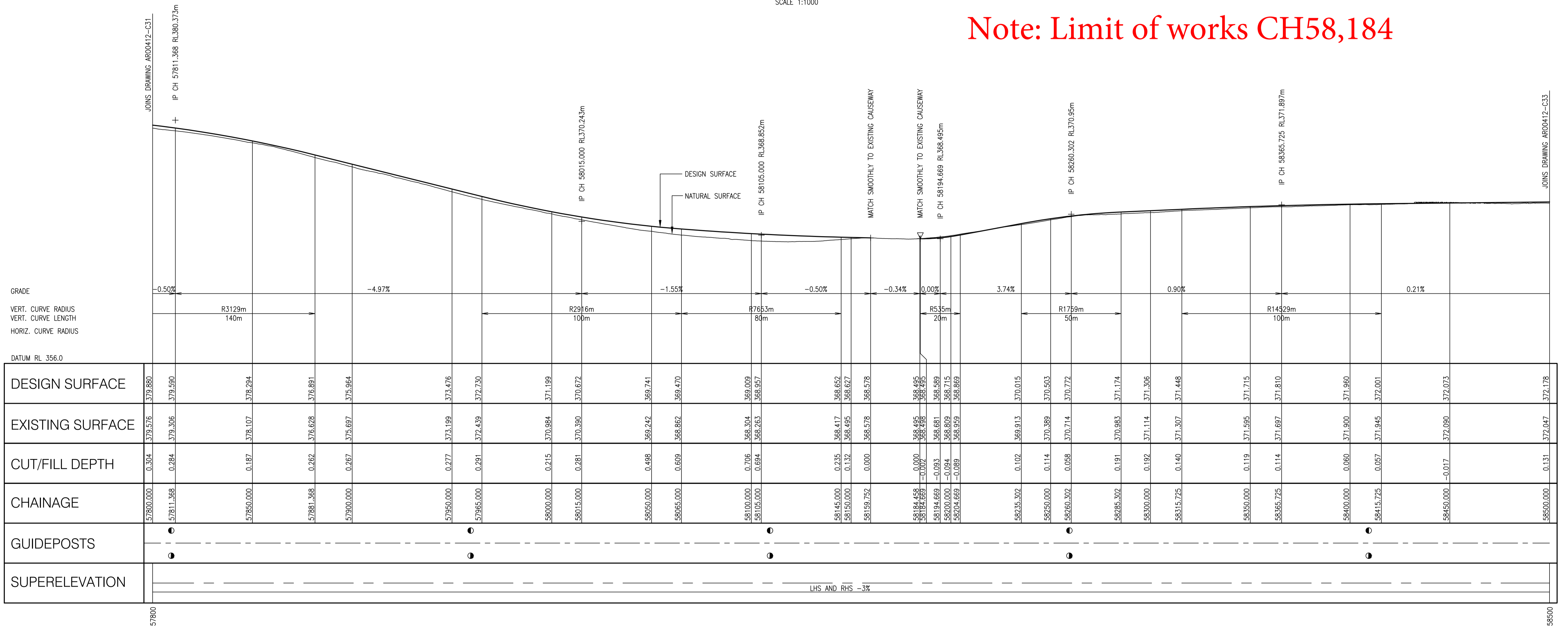

DESIGN CONTROL LINE LONGITUDINAL SECTION
SCALE 1:1000 HOR, 1:200 VERT

NOTES

- REFER TO DRAWING ARO0412-C49 FOR LEGEND AND ARO0412-C01 FOR NOTES.

TENDER ISSUE ONLY

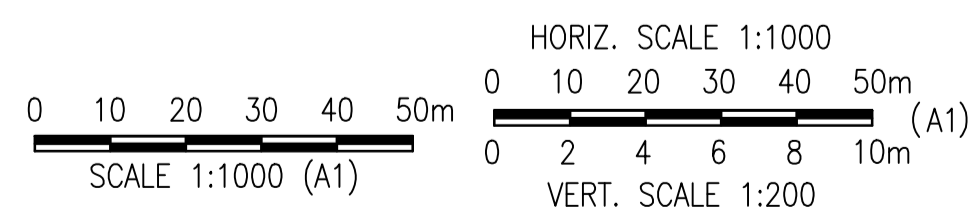

No.	Description	Reviewed	Approved	Date
1	TENDER ISSUE ONLY	-	-	23/08/2024

Client Logo



Client	BANANA SHIRE COUNCIL
Project	DEFENCE ROAD UPGRADE - CH 36,172 - CH68,499
Title	WORKING PLAN - SHEET 32 OF 47
Drawing No.	ARO0412-C33

Drawn	MS	Designed	MS	Approved		Scale (A1 size)	AS SHOWN
Drawing Check		Design Check		RPEQ	Date	Drawing is not to be used for construction unless approved.	
							51 Sheridan Street Cairns Qld 4870 T (07) 4281 6897 E admin@arindustries.com.au W www.arindustries.com.au ABN: 49 641 461 298

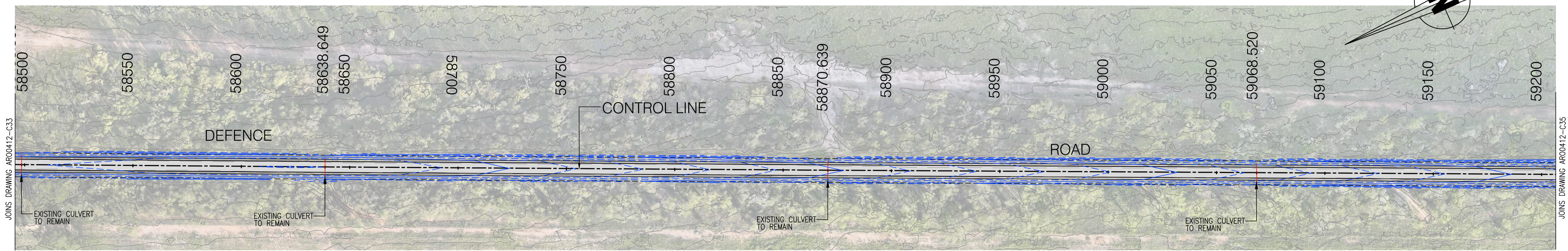

PLAN
SCALE 1:1000

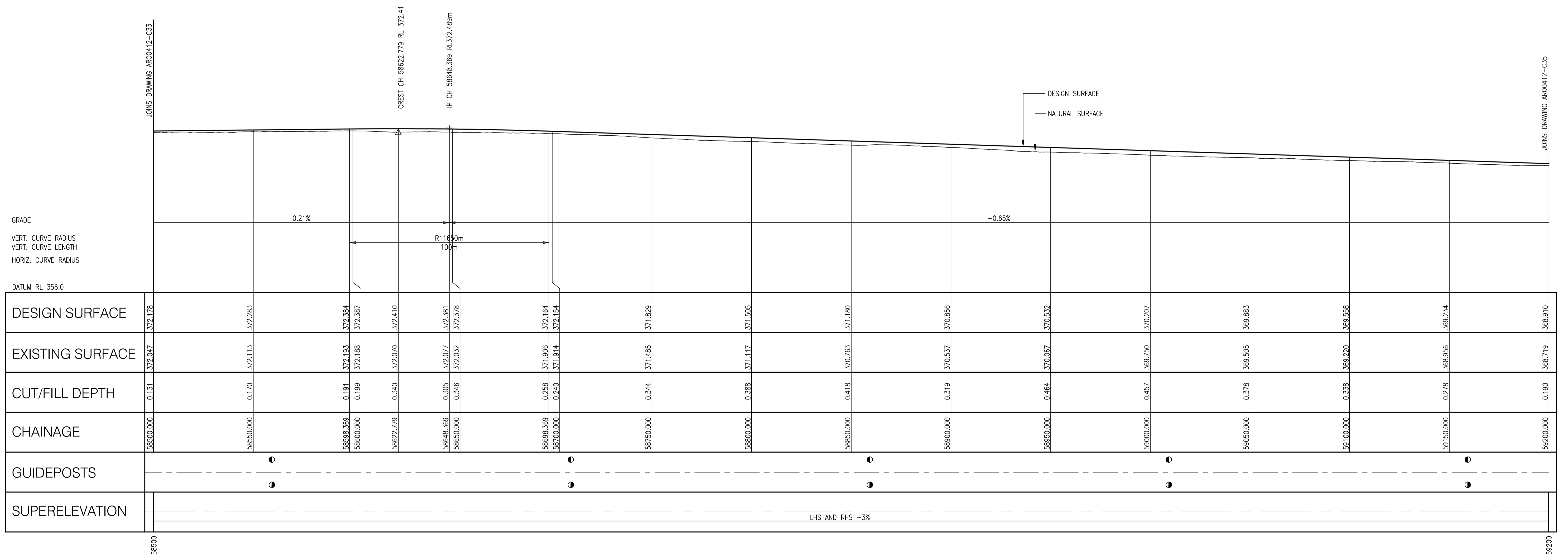

DESIGN CONTROL LINE LONGITUDINAL SECTION
SCALE 1:1000 HOR, 1:200 VERT

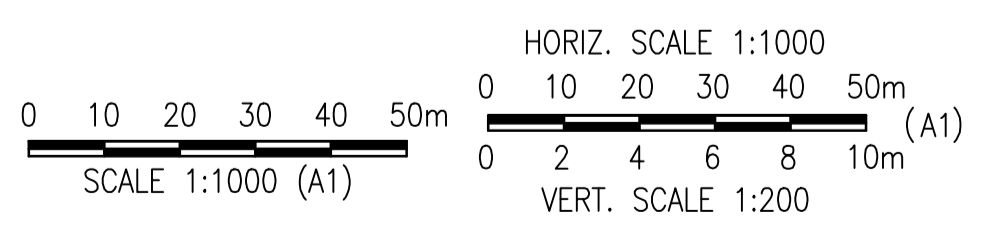

NOTES
1. REFER TO DRAWING ARO0412-C49 FOR LEGEND AND ARO0412-C01 FOR NOTES.
TENDER ISSUE ONLY

No.	Description	Reviewed	Approved	Date
1	TENDER ISSUE ONLY	-	-	23/08/2024



Client	BANANA SHIRE COUNCIL
Project	DEFENCE ROAD UPGRADE - CH 36,172 - CH68,499
Title	WORKING PLAN - SHEET 33 OF 47

Drawn	MS	Designed	MS	Approved		Scale (A1 size)	AS SHOWN
Drawing Check		Design Check		RPEQ	Date	Drawing is not to be used for construction unless approved.	

51 Sheridan Street
Cairns Qld 4870
T (07) 4281 6897
E admin@aroindustries.com.au
W www.aroindustries.com.au
ABN: 49 641 461 298

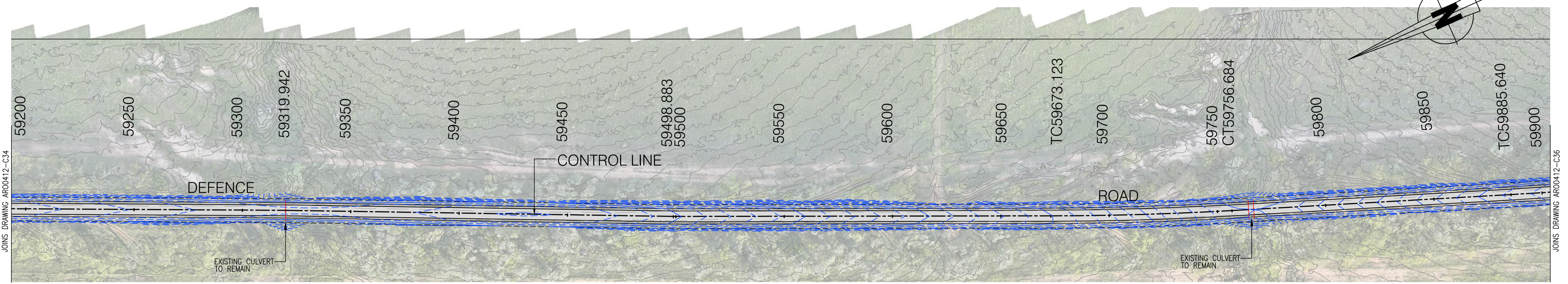

PLAN
SCALE 1:1000

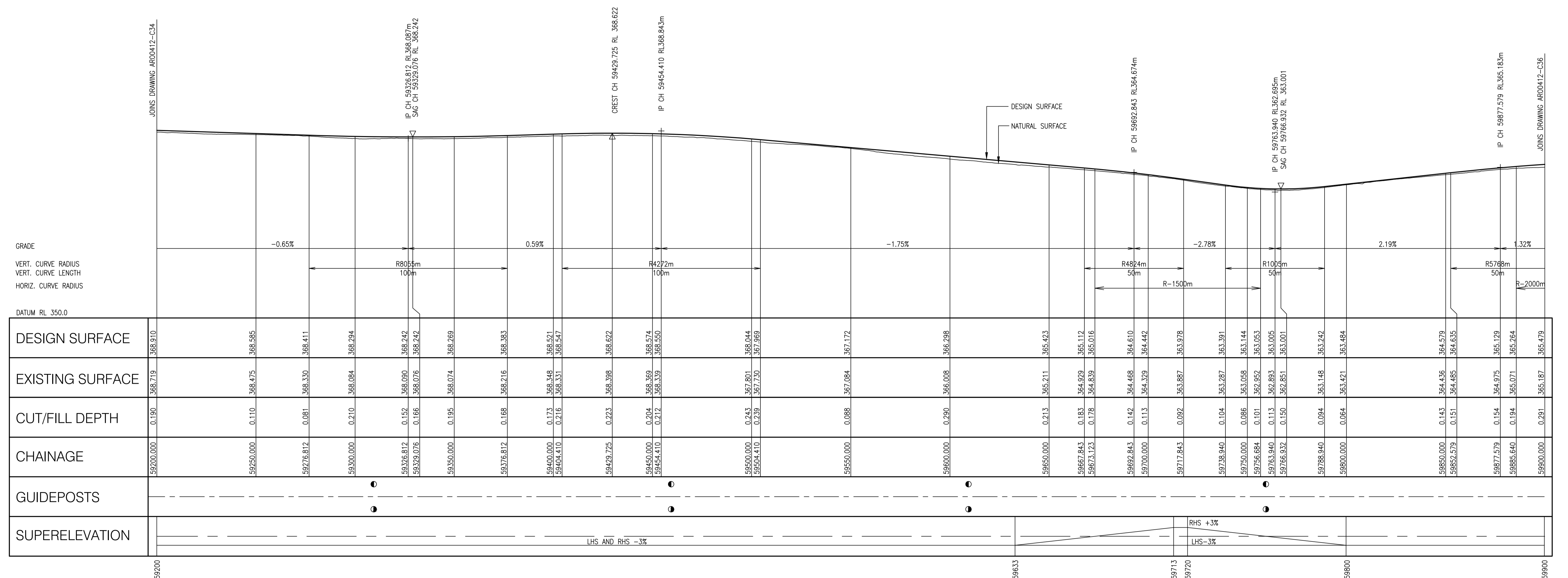

DESIGN CONTROL LINE LONGITUDINAL SECTION
SCALE 1:1000 HOR, 1:200 VERT

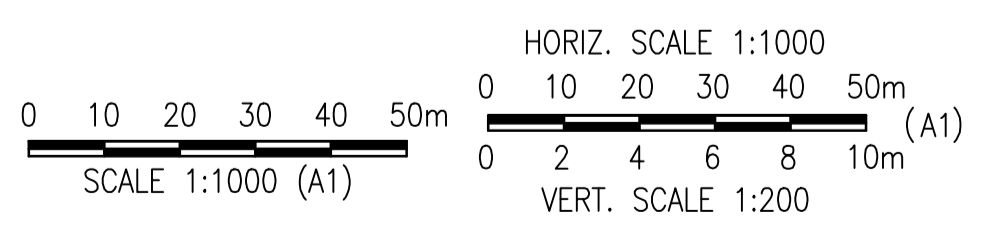

NOTES
1. REFER TO DRAWING ARO0412-C49 FOR LEGEND AND ARO0412-C01 FOR NOTES.
TENDER ISSUE ONLY

No.	Description	Reviewed	Approved	Date
1	TENDER ISSUE ONLY	-	-	23/08/2024



Client	BANANA SHIRE COUNCIL		
Project	DEFENCE ROAD UPGRADE - CH 36,172 - CH68,499		
Title	WORKING PLAN - SHEET 34 OF 47		
Client Logo	Banana SHIRE SHIRE OF OPPORTUNITY		

Drawn	MS	Designed	MS	Approved		Scale (A1 size)	AS SHOWN
Drawing Check		Design Check		RPEQ	Date	Drawing is not to be used for construction unless approved.	

51 Sheridan Street
Cairns Qld 4870
T (07) 4281 6897
E admin@aroindustries.com.au
W www.aroindustries.com.au
ABN: 49 641 461 298

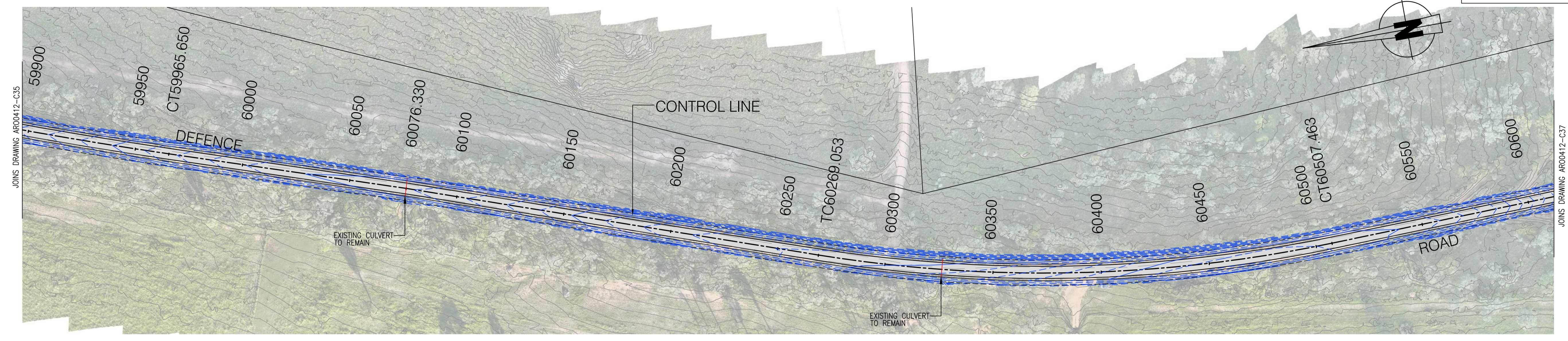

PLAN
SCALE 1:1000

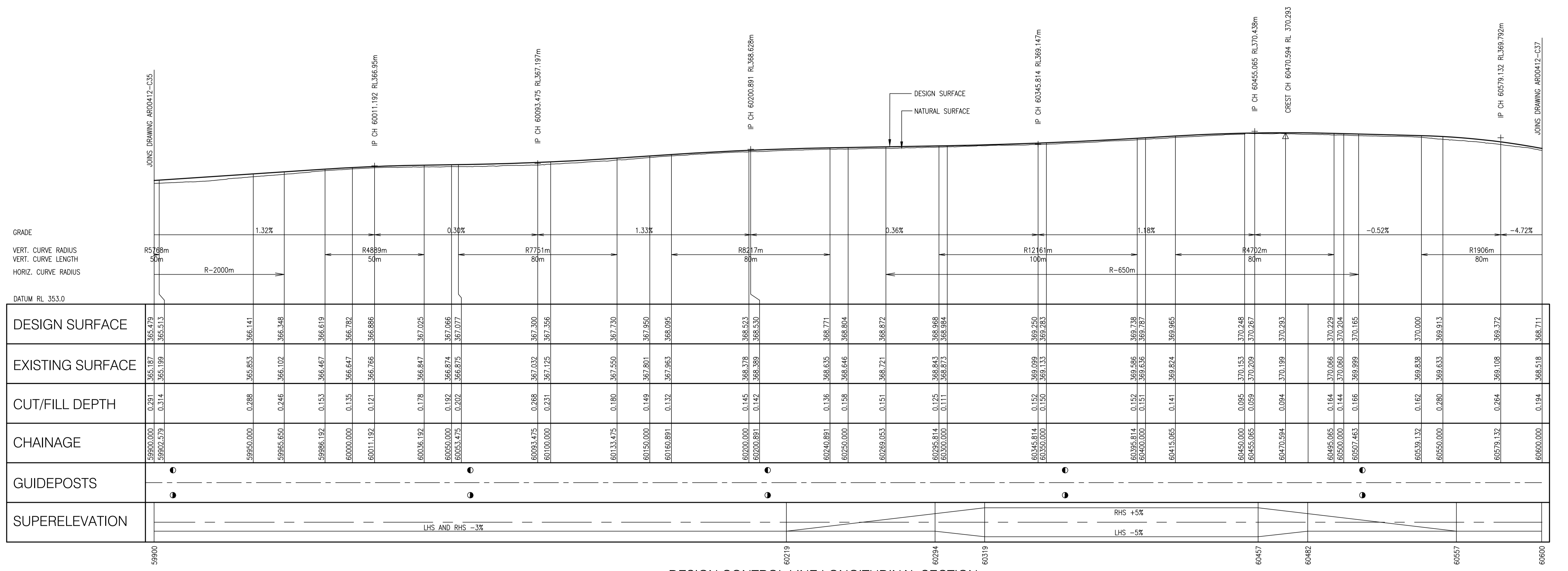

DESIGN CONTROL LINE LONGITUDINAL SECTION
SCALE 1:1000 HOR, 1:200 VERT

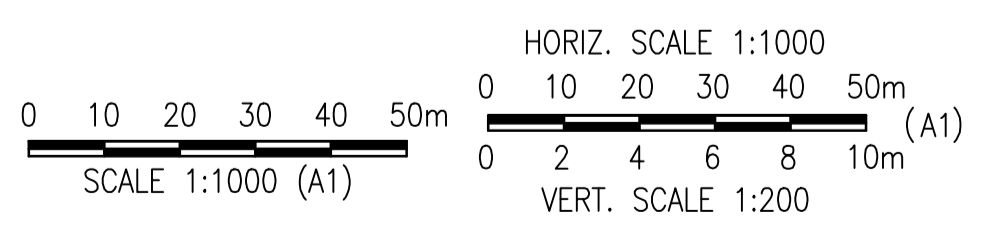

NOTES
1. REFER TO DRAWING ARO0412-C49 FOR LEGEND AND ARO0412-C01 FOR NOTES.

TENDER ISSUE ONLY

No.	Description	Reviewed	Approved	Date
1	TENDER ISSUE ONLY	-	-	23/08/2024



Client	BANANA SHIRE COUNCIL
Project	DEFENCE ROAD UPGRADE - CH 36,172 - CH68,499
Title	WORKING PLAN - SHEET 35 OF 47
Drawing No.	ARO0412-C36

Drawn	MS	Designed	MS	Approved	RPEQ	Date	Scale (A1 size)	AS SHOWN
Drawing Check	Design Check	RPEQ	Date	Drawing is not to be used for construction unless approved.				

51 Sheridan Street
Cairns Qld 4870
T (07) 4281 6897
E admin@aroindustries.com.au
W www.aroindustries.com.au
ABN: 49 641 461 298

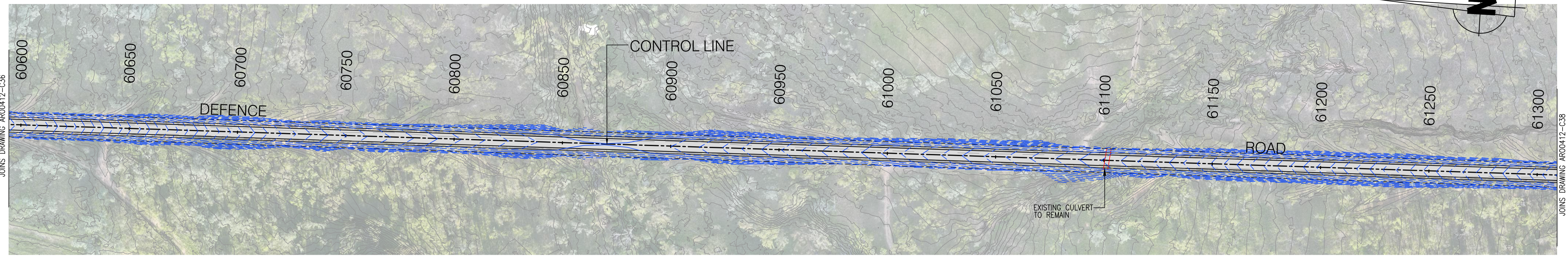

PLAN
SCALE 1:1000

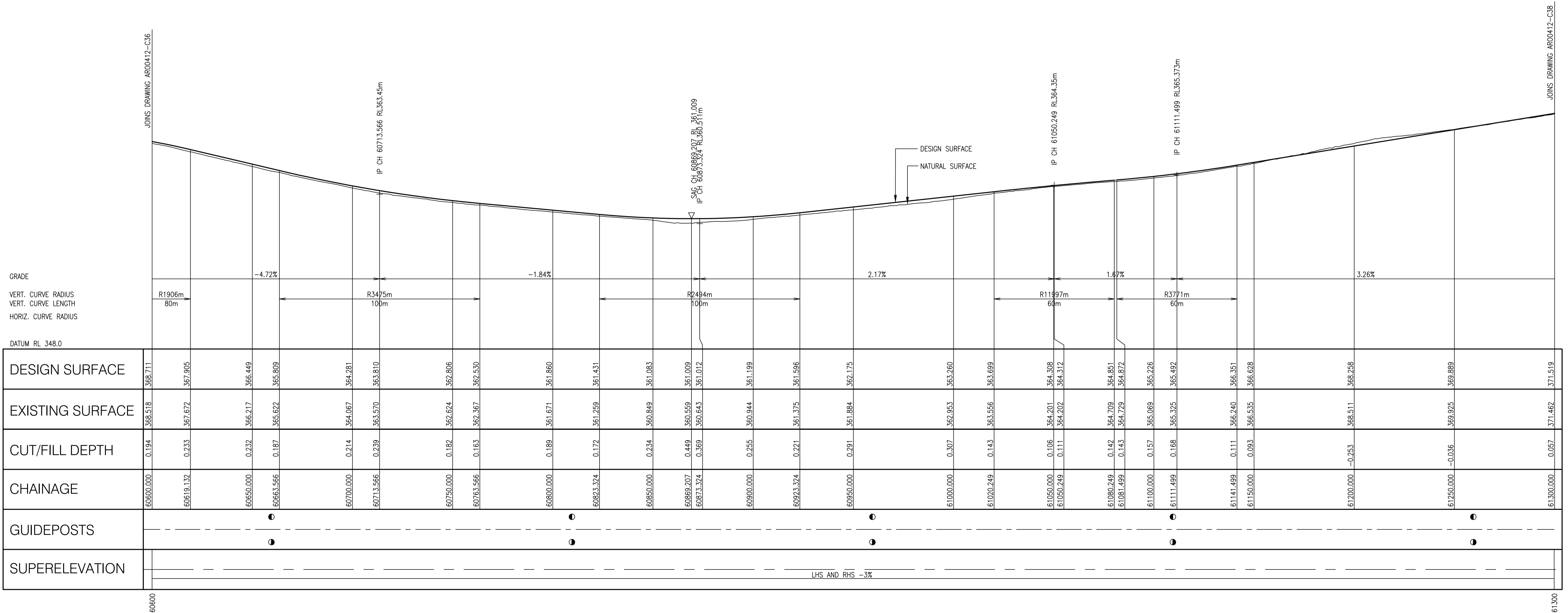

DESIGN CONTROL LINE LONGITUDINAL SECTION
SCALE 1:1000 HOR, 1:200 VERT

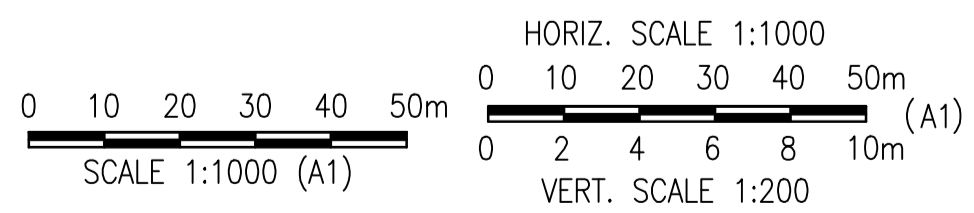

NOTES

- REFER TO DRAWING ARO0412-C49 FOR LEGEND AND ARO0412-C01 FOR NOTES.

TENDER ISSUE ONLY

No.	Description	Reviewed	Approved	Date
1	TENDER ISSUE ONLY	-	-	23/08/2024



Client	BANANA SHIRE COUNCIL
Project	DEFENCE ROAD UPGRADE - CH 36,172 - CH68,499
Title	WORKING PLAN - SHEET 36 OF 47

Drawn	MS	Designed	MS	Approved		Scale (A1 size)	AS SHOWN
Drawing Check		Design Check		RPEQ	Date	Drawing is not to be used for construction unless approved.	

51 Sheridan Street
Cairns Qld 4870
T (07) 4281 6897
E admin@aroindustries.com.au
W www.aroindustries.com.au
ABN: 49 641 461 298

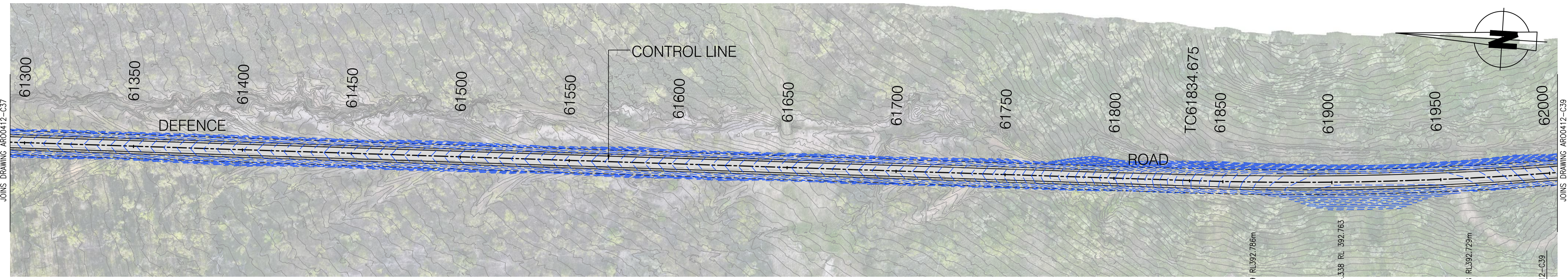

PLAN
SCALE 1:1000

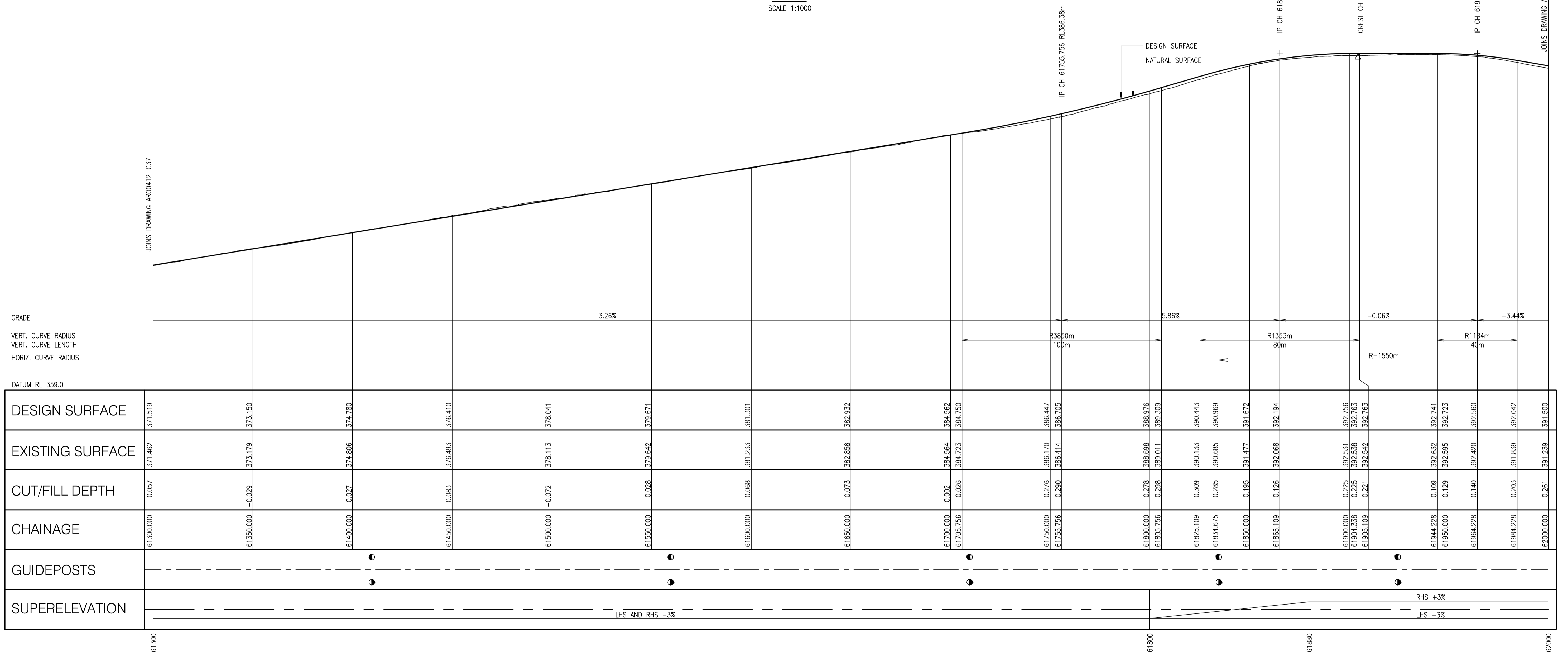

DESIGN CONTROL LINE LONGITUDINAL SECTION
SCALE 1:1000 HOR, 1:200 VERT

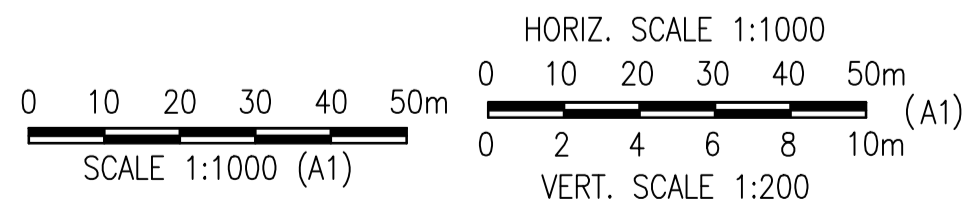

NOTES

- REFER TO DRAWING ARO0412-C49 FOR LEGEND AND ARO0412-C01 FOR NOTES.

TENDER ISSUE ONLY

No.	Description	Reviewed	Approved	Date
1	TENDER ISSUE ONLY	-	-	23/08/2024



Client	BANANA SHIRE COUNCIL		
Project	DEFENCE ROAD UPGRADE - CH 36,172 - CH68,499		
Title	WORKING PLAN - SHEET 37 OF 47		
Drawing No.	ARO0412-C38		

Drawn	MS	Designed	MS	Approved		Scale (A1 size)	AS SHOWN
Drawing Check		Design Check		RPEQ	Date	Drawing is not to be used for construction unless approved.	

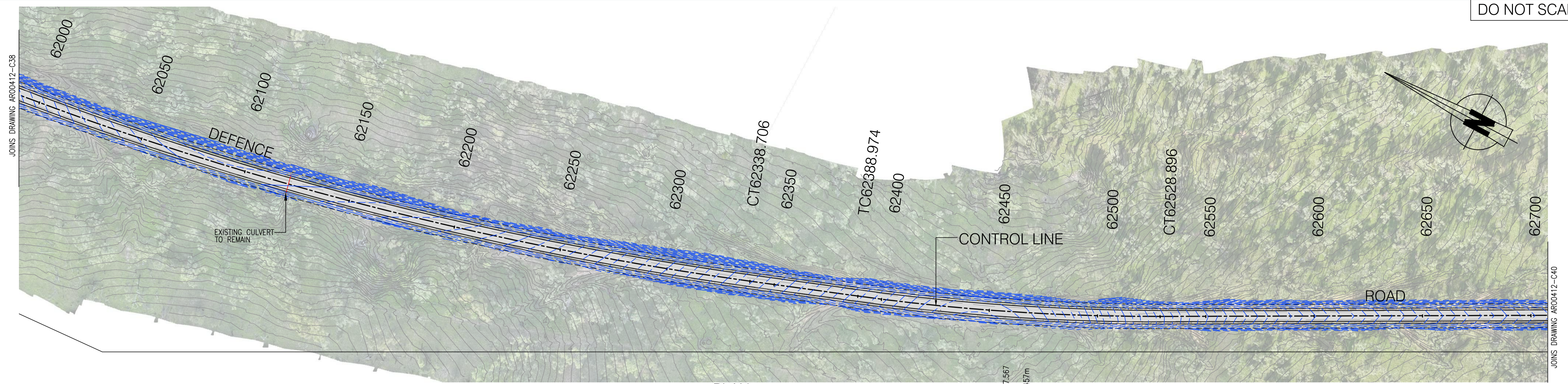

PLAN
SCALE 1:1000

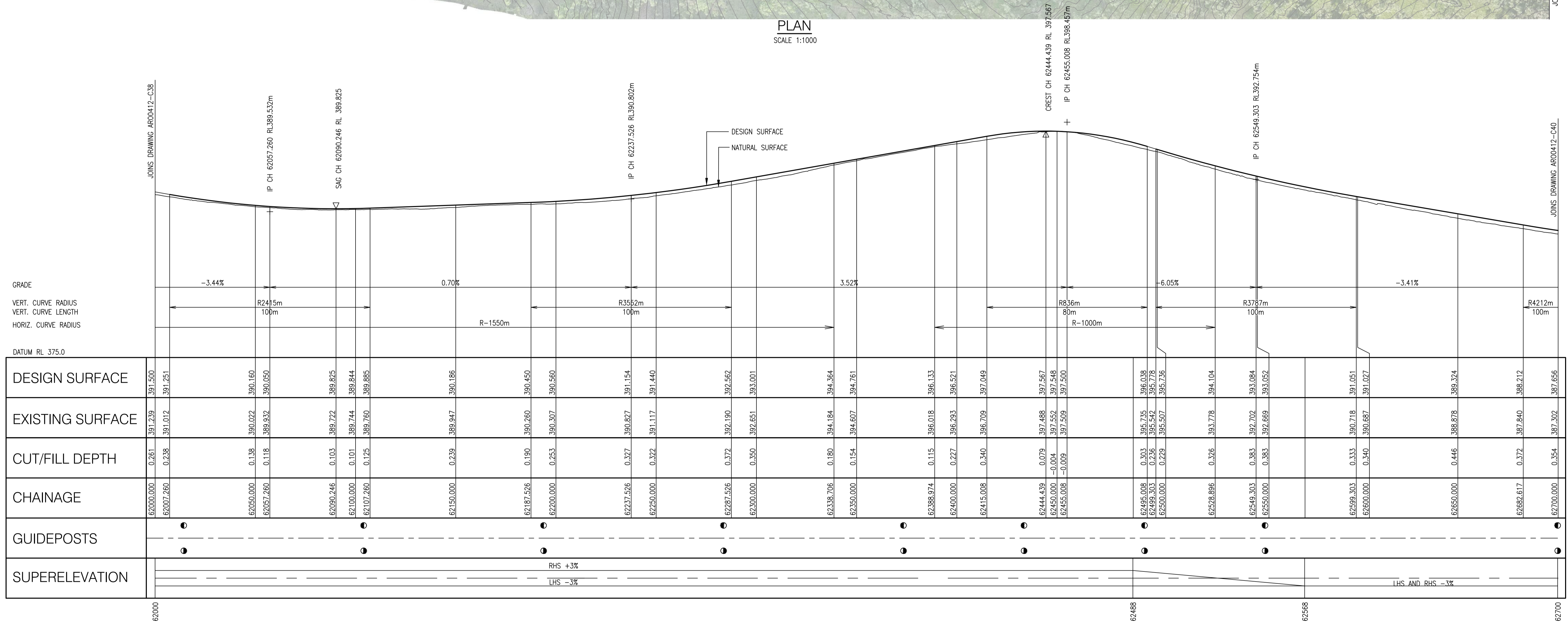

DESIGN CONTROL LINE LONGITUDINAL SECTION
SCALE 1:1000 HOR, 1:200 VERT

NOTES

- REFER TO DRAWING ARO0412-C49 FOR LEGEND AND ARO0412-C01 FOR NOTES.

TENDER ISSUE ONLY

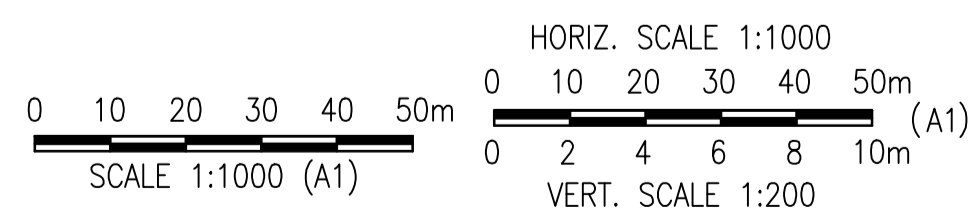

No.	Description	Reviewed	Approved	Date
1	TENDER ISSUE ONLY			23/08/2024



Client	BANANA SHIRE COUNCIL		
Project	DEFENCE ROAD UPGRADE - CH 36,172 - CH68,499		
Title	WORKING PLAN - SHEET 38 OF 47		
Client Logo			
Drawing No.	ARO0412-C39		

Drawn	MS	Designed	MS	Approved		Scale (A1 size)	AS SHOWN
Drawing Check		Design Check		RPEQ	Date	Drawing is not to be used for construction unless approved.	
51 Sheridan Street Cairns Qld 4870 T (07) 4281 6897 E admin@arindustries.com.au W www.arindustries.com.au ABN: 49 641 461 298							

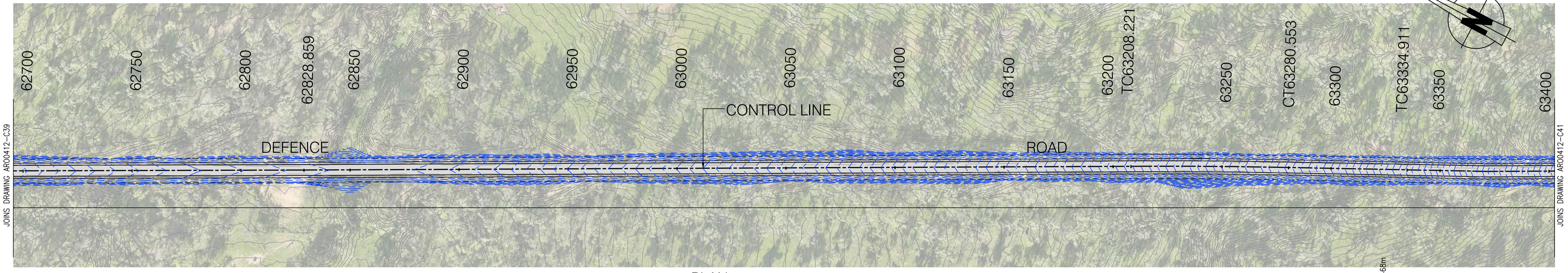

PLAN
SCALE 1:1000

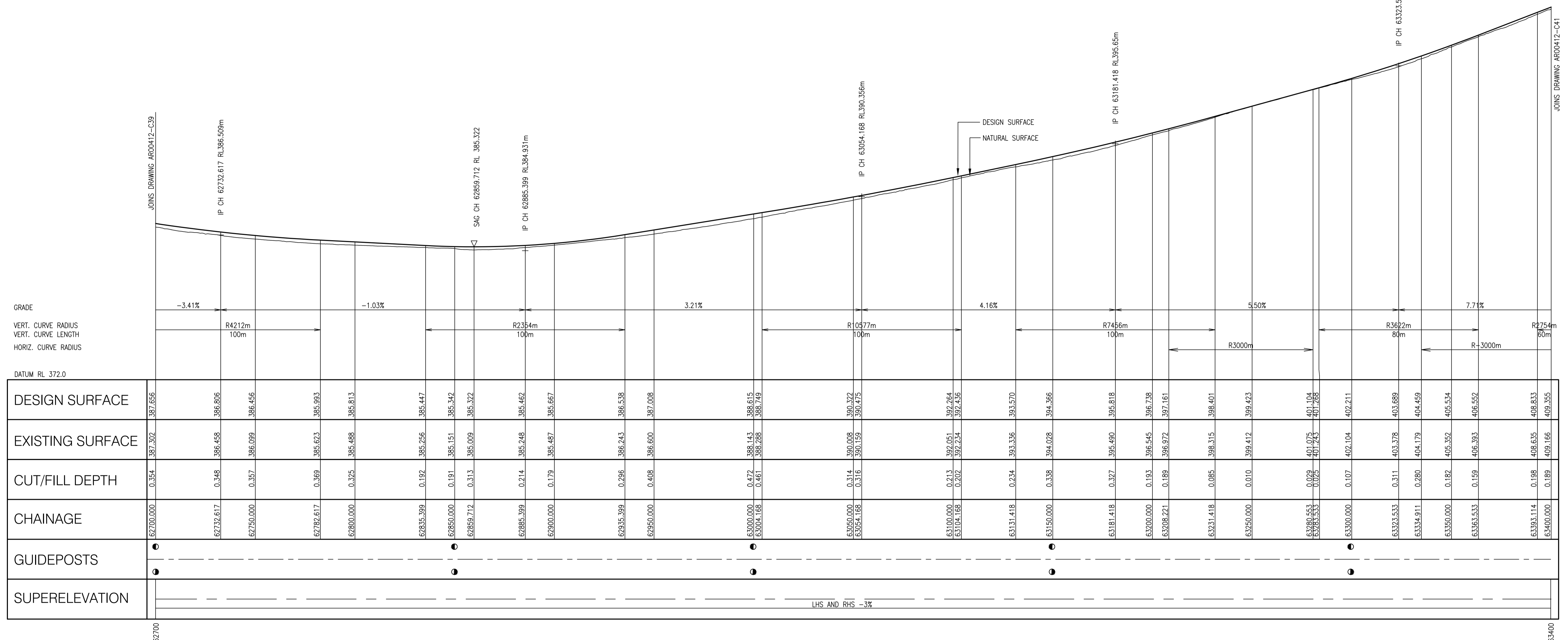

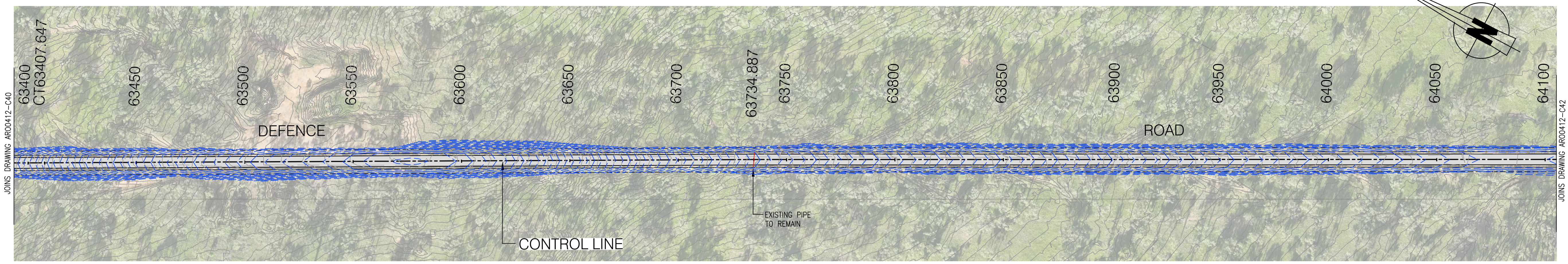

PLAN
SCALE 1:1000

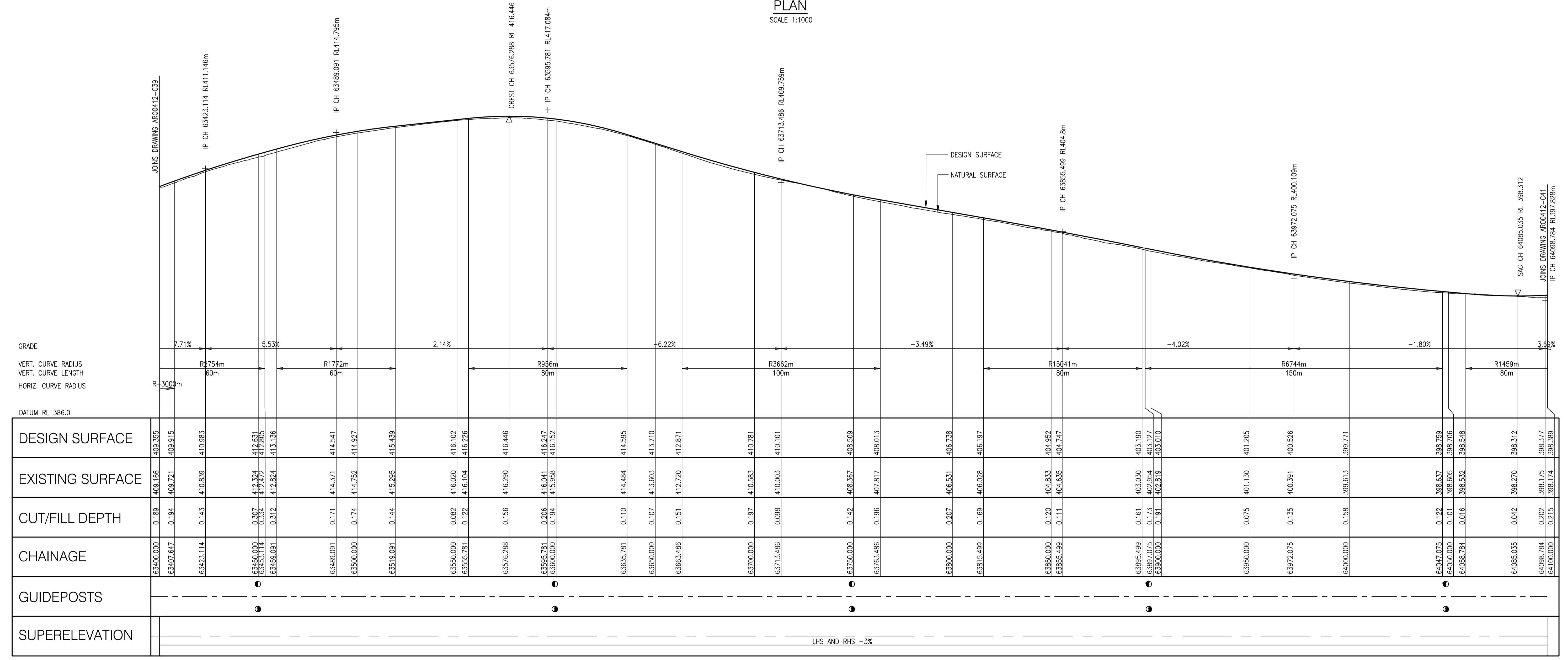

DESIGN CONTROL LINE LONGITUDINAL SECTION
SCALE 1:1000 HOR, 1:200 VERT

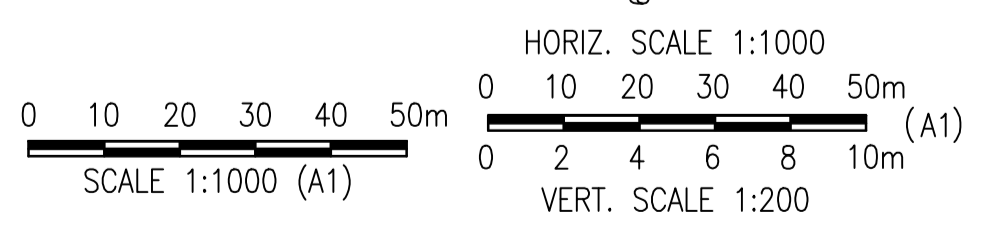

NOTES
1. REFER TO DRAWING ARO0412-C49 FOR LEGEND AND ARO0412-C01 FOR NOTES.

TENDER ISSUE ONLY

No.	Description	Reviewed	Approved	Date
1	TENDER ISSUE ONLY			23/08/2024



Client	BANANA SHIRE COUNCIL		
Project	DEFENCE ROAD UPGRADE - CH 36,172 - CH68,499		
Title	WORKING PLAN - SHEET 40 OF 47		

Drawn	MS	Designed	MS	Approved	RPEQ	Date
Drawing Check		Design Check				

Scale (A1 size)
AS SHOWN

Drawing is not to be used for construction unless approved.

51 Sheridan Street
Cairns Qld 4870
T (07) 4281 6897
E admin@arindustries.com.au
W www.arindustries.com.au
ABN: 49 641 461 298

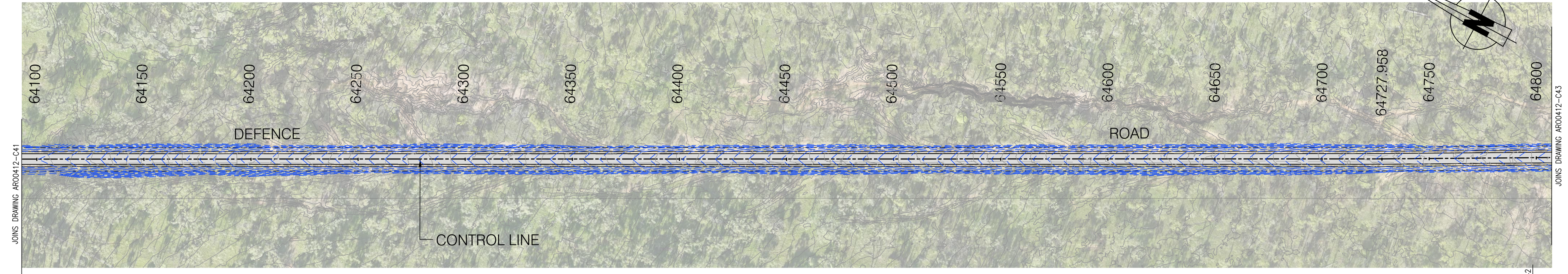

PLAN
SCALE 1:1000

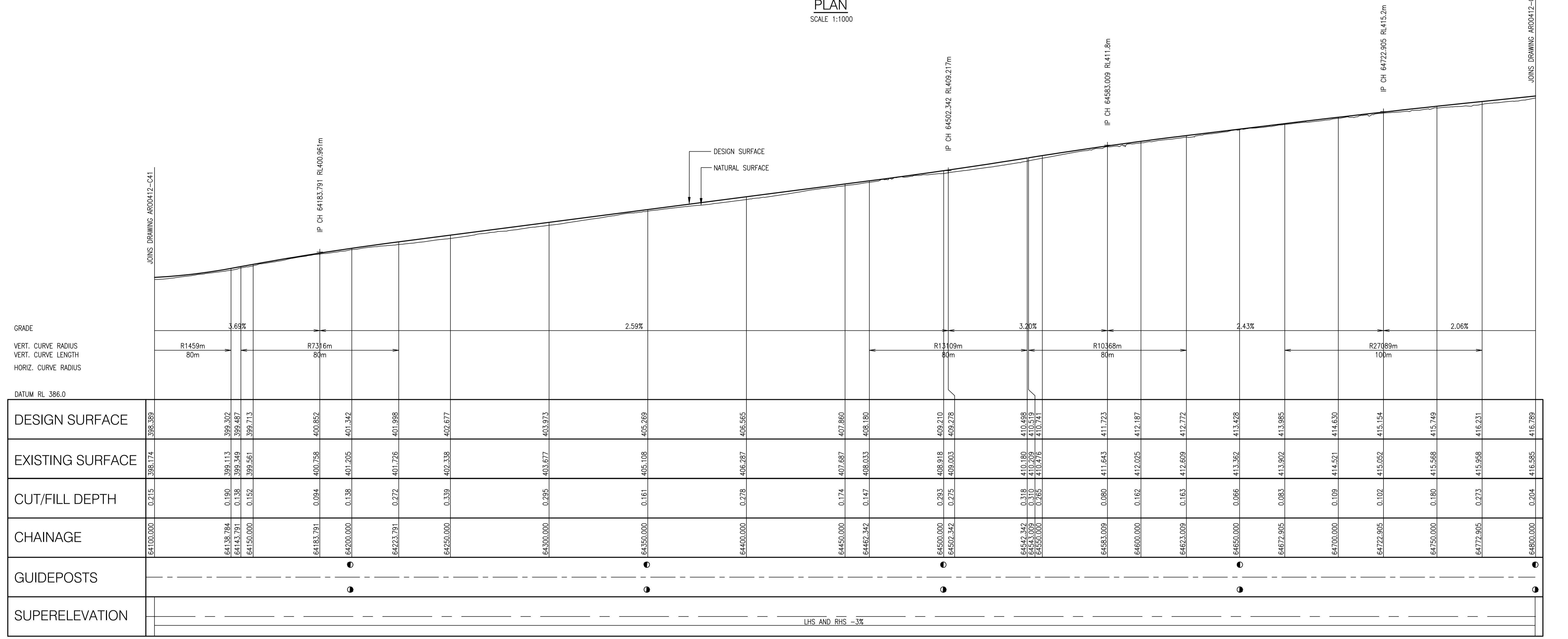

DESIGN CONTROL LINE LONGITUDINAL SECTION
SCALE 1:1000 HOR, 1:200 VERT

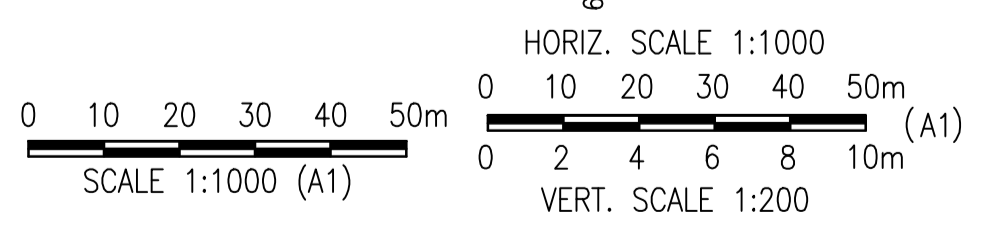

NOTES
1. REFER TO DRAWING ARO0412-C49 FOR LEGEND AND ARO0412-C01 FOR NOTES.
TENDER ISSUE ONLY

No.	Description	Reviewed	Approved	Date
1	TENDER ISSUE ONLY	-	-	23/08/2024



Client	BANANA SHIRE COUNCIL		
Project	DEFENCE ROAD UPGRADE - CH 36,172 - CH68,499		
Title	WORKING PLAN - SHEET 41 OF 47		
Drawing No.	ARO0412-C42		

Drawn	MS	Designed	MS	Approved		Scale (A1 size)	AS SHOWN
Drawing Check		Design Check		RPEQ	Date	Drawing is not to be used for construction unless approved.	

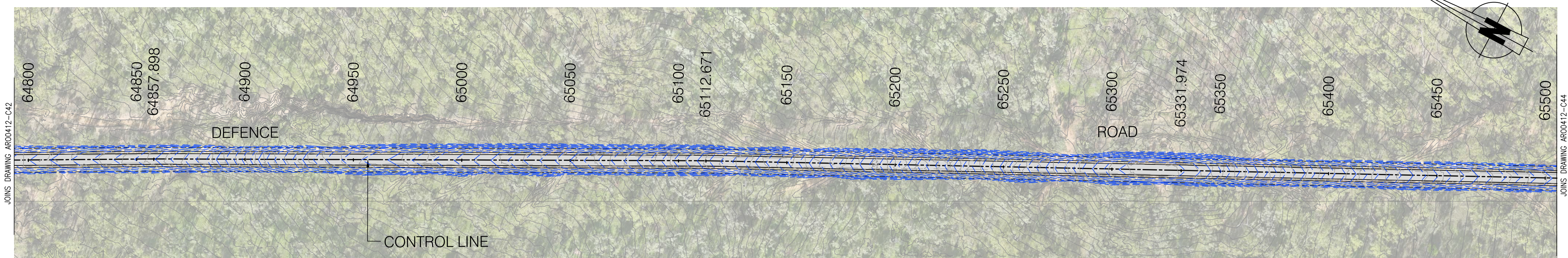

PLAN
SCALE 1:1000

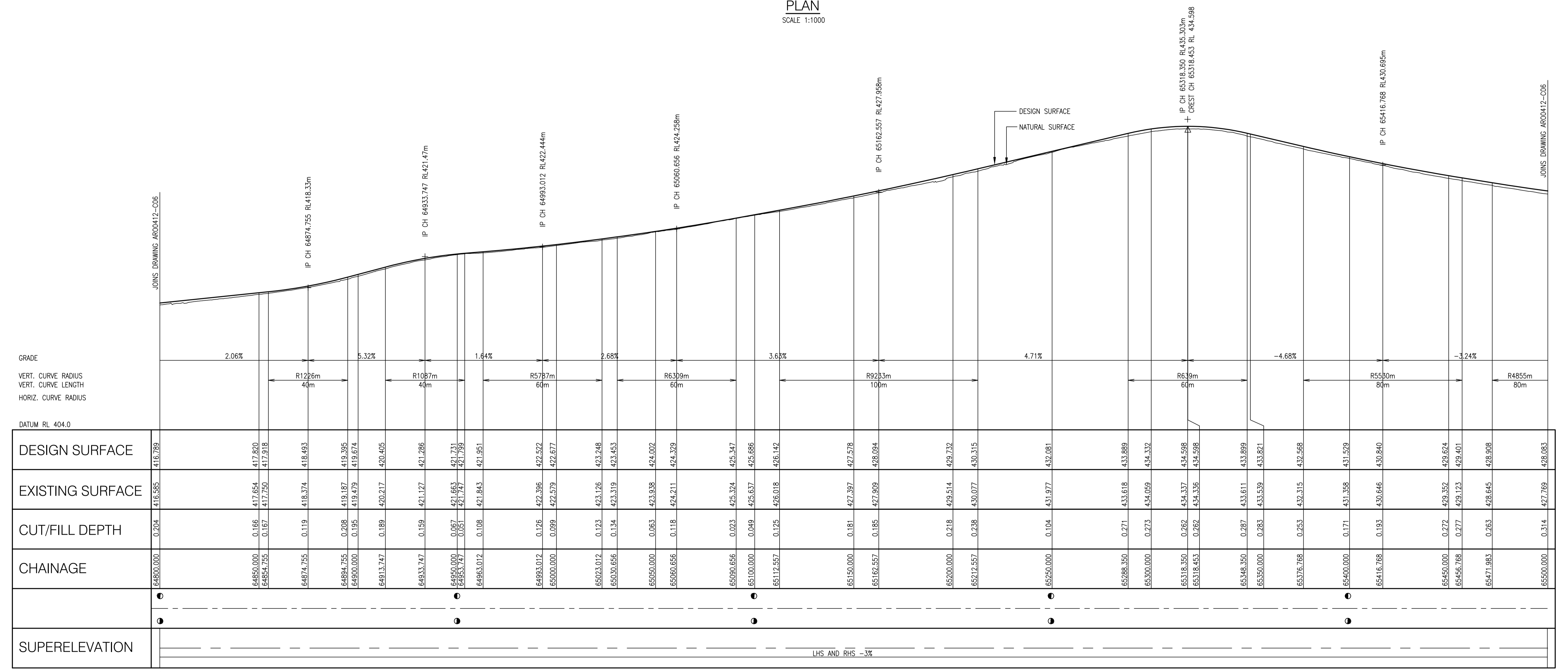

DESIGN CONTROL LINE LONGITUDINAL SECTION
SCALE 1:1000 HOR, 1:200 VERT

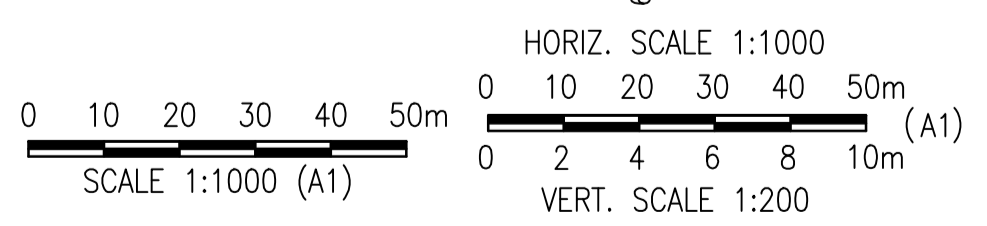

NOTES
1. REFER TO DRAWING ARO0412-C49 FOR LEGEND AND ARO0412-C01 FOR NOTES.
TENDER ISSUE ONLY

No.	Description	Reviewed	Approved	Date
1	TENDER ISSUE ONLY	-	-	23/08/2024



Client: BANANA SHIRE COUNCIL
Project: DEFENCE ROAD UPGRADE - CH 36,172 - CH68,499
Title: WORKING PLAN - SHEET 42 OF 47
Drawing No.: ARO0412-C43

Drawn	Designed	Approved	Scale (A1 size)
MS	MS		AS SHOWN
Drawing Check	Design Check	RPEQ	Date

Drawing is not to be used for construction unless approved.

51 Sheridan Street
Cairns Qld 4870
T (07) 4281 6897
E admin@aroindustries.com.au
W www.aroindustries.com.au
ABN: 49 641 461 298

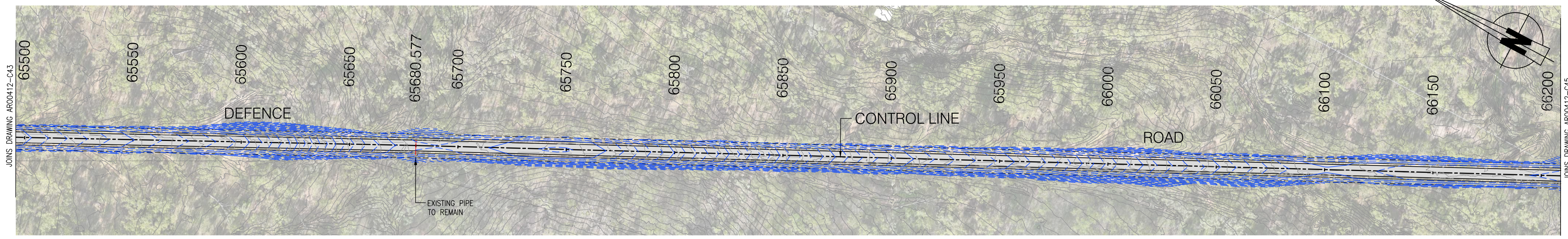

PLAN
SCALE 1:1000

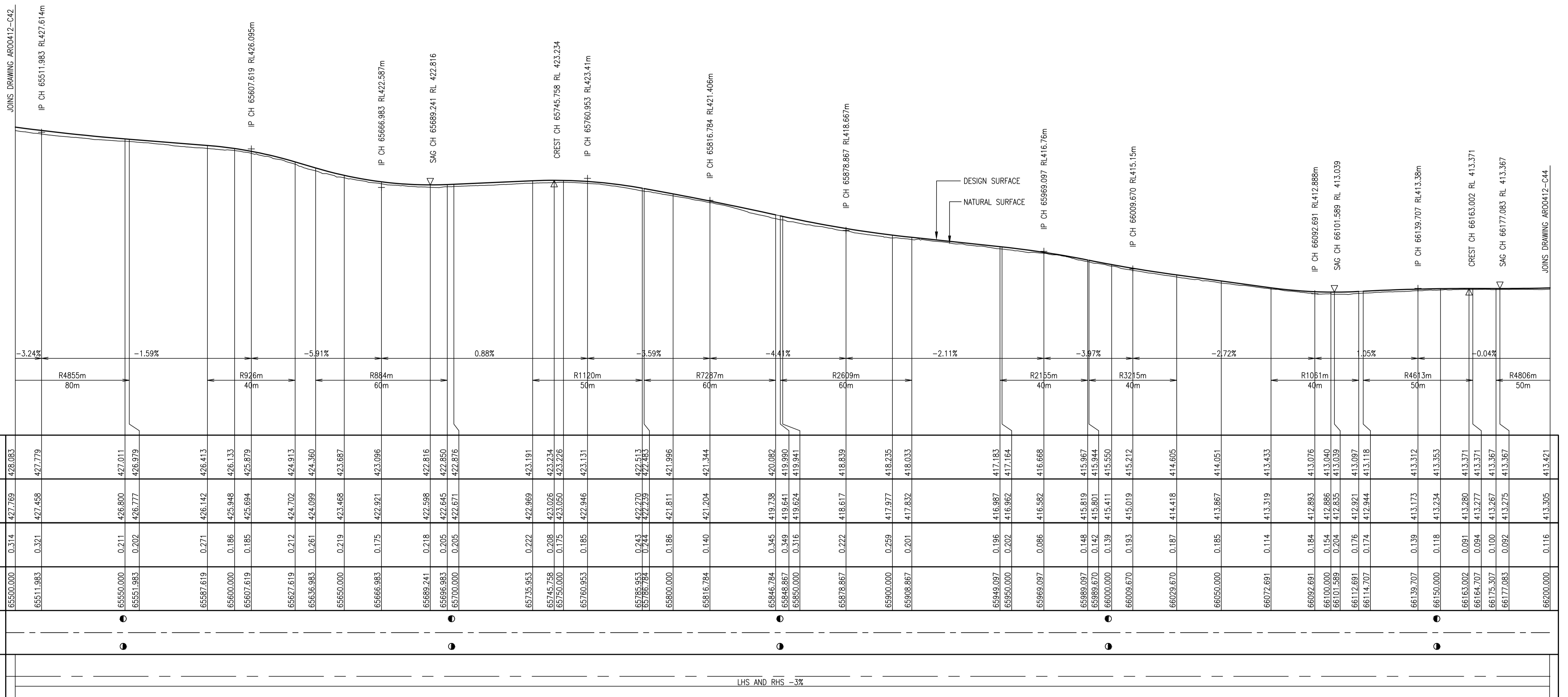

DESIGN CONTROL LINE LONGITUDINAL SECTION
SCALE 1:1000 HOR, 1:200 VERT

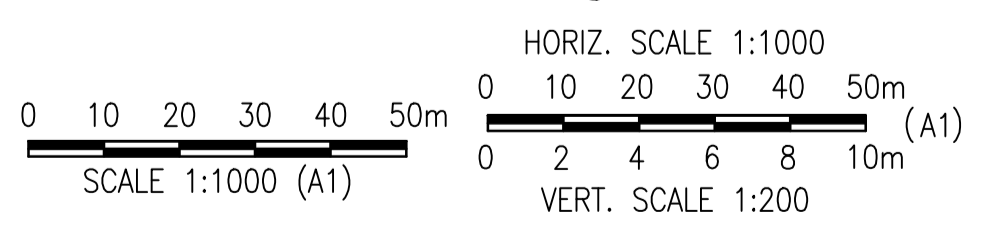

NOTES
1. REFER TO DRAWING ARO0412-C49 FOR LEGEND AND ARO0412-C01 FOR NOTES.

TENDER ISSUE ONLY

No.	Description	Reviewed	Approved	Date
1	TENDER ISSUE ONLY			23/08/2024



Client	BANANA SHIRE COUNCIL		
Project	DEFENCE ROAD UPGRADE - CH 36,172 - CH68,499		
Title	WORKING PLAN - SHEET 43 OF 47		

Drawn	MS	Designed	MS	Approved	
Drawing Check		Design Check		RPEQ	Date

Scale (A1 size)
AS SHOWN

Drawing is not to be used for construction unless approved.

51 Sheridan Street
Cairns Qld 4870
T (07) 4281 6897
E admin@aroindustries.com.au
W www.aroindustries.com.au
ABN: 49 641 461 298

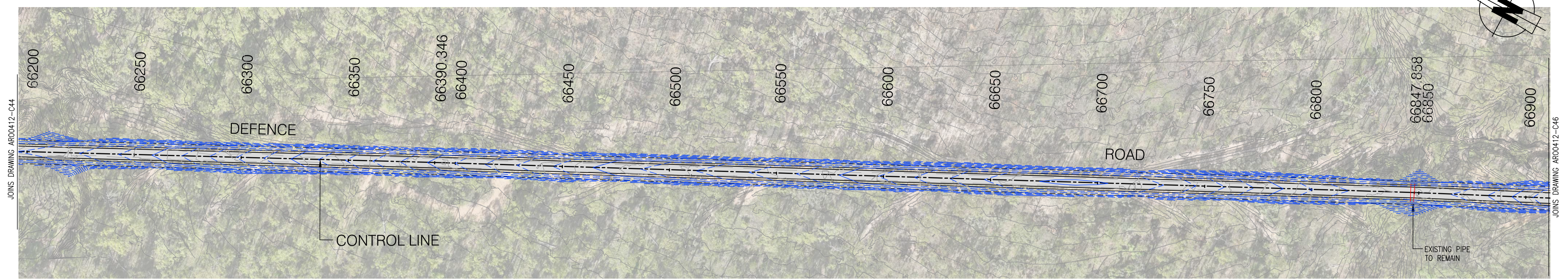

PLAN
SCALE 1:1000

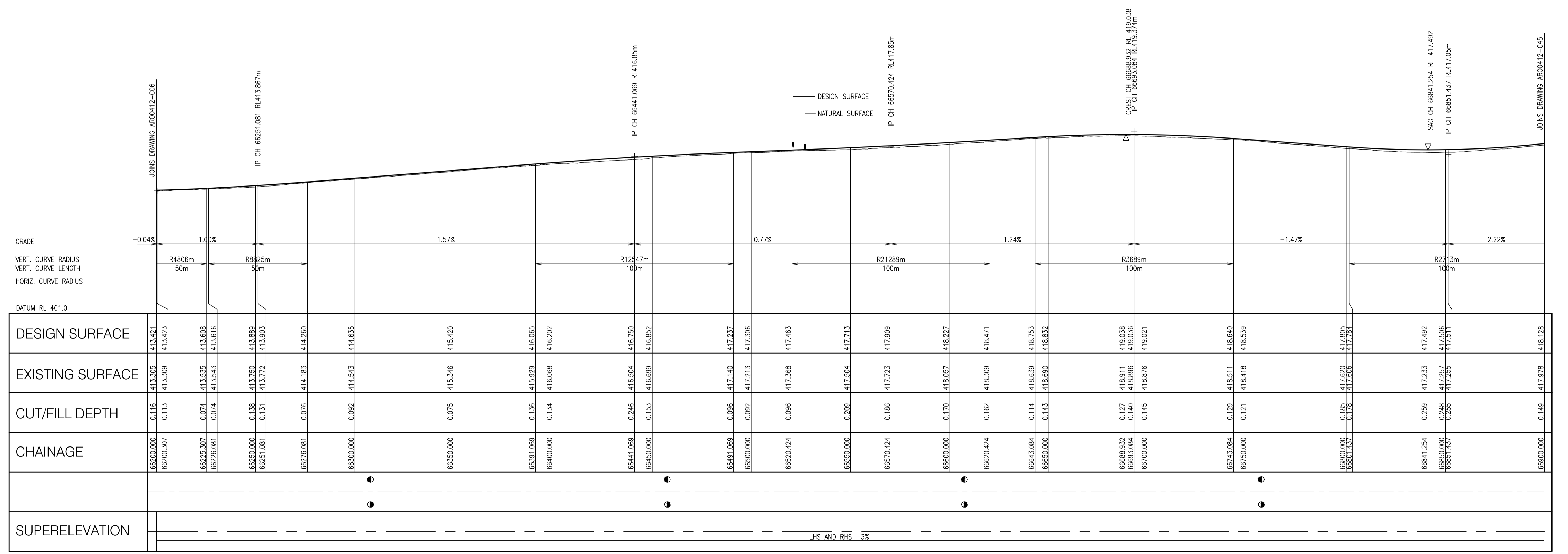

DESIGN CONTROL LINE LONGITUDINAL SECTION
SCALE 1:1000 HOR, 1:200 VERT

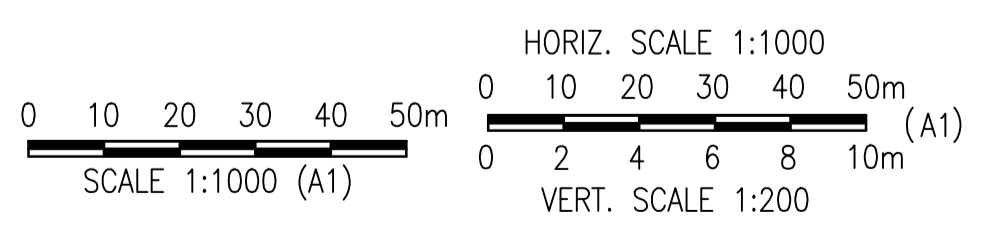

NOTES
1. REFER TO DRAWING ARO0412-C49 FOR LEGEND AND ARO0412-C01 FOR NOTES.

TENDER ISSUE ONLY

No.	Description	Reviewed	Approved	Date
1	TENDER ISSUE ONLY			23/08/2024



Client	BANANA SHIRE COUNCIL		
Project	DEFENCE ROAD UPGRADE - CH 36,172 - CH68,499		
Title	WORKING PLAN - SHEET 44 OF 47		
Drawing No.	ARO0412-C45		

Drawn	MS	Designed	MS	Approved	
Drawing Check		Design Check		RPEQ	Date

Scale (A1 size)
AS SHOWN

Drawing is not to be used for construction unless approved.

51 Sheridan Street
Cairns Qld 4870
T (07) 4281 6897
E admin@aroindustries.com.au
W www.aroindustries.com.au
ABN: 49 641 461 298

DO NOT SCALE

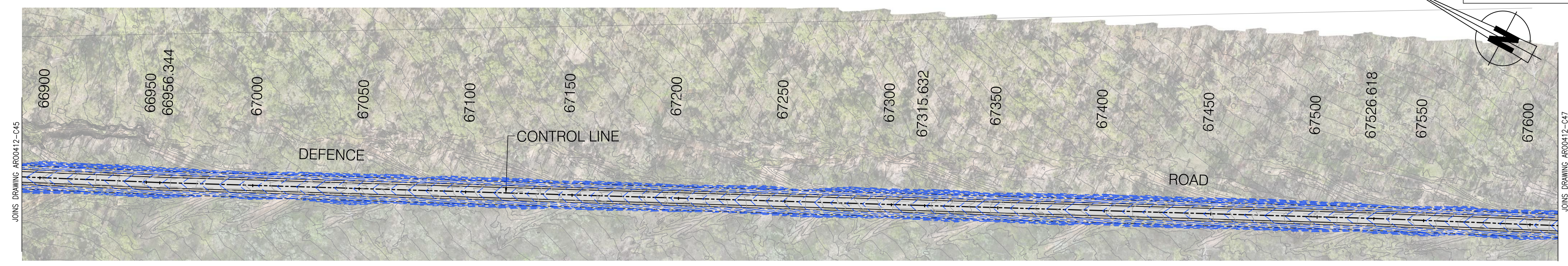

PLAN
SCALE 1:1000

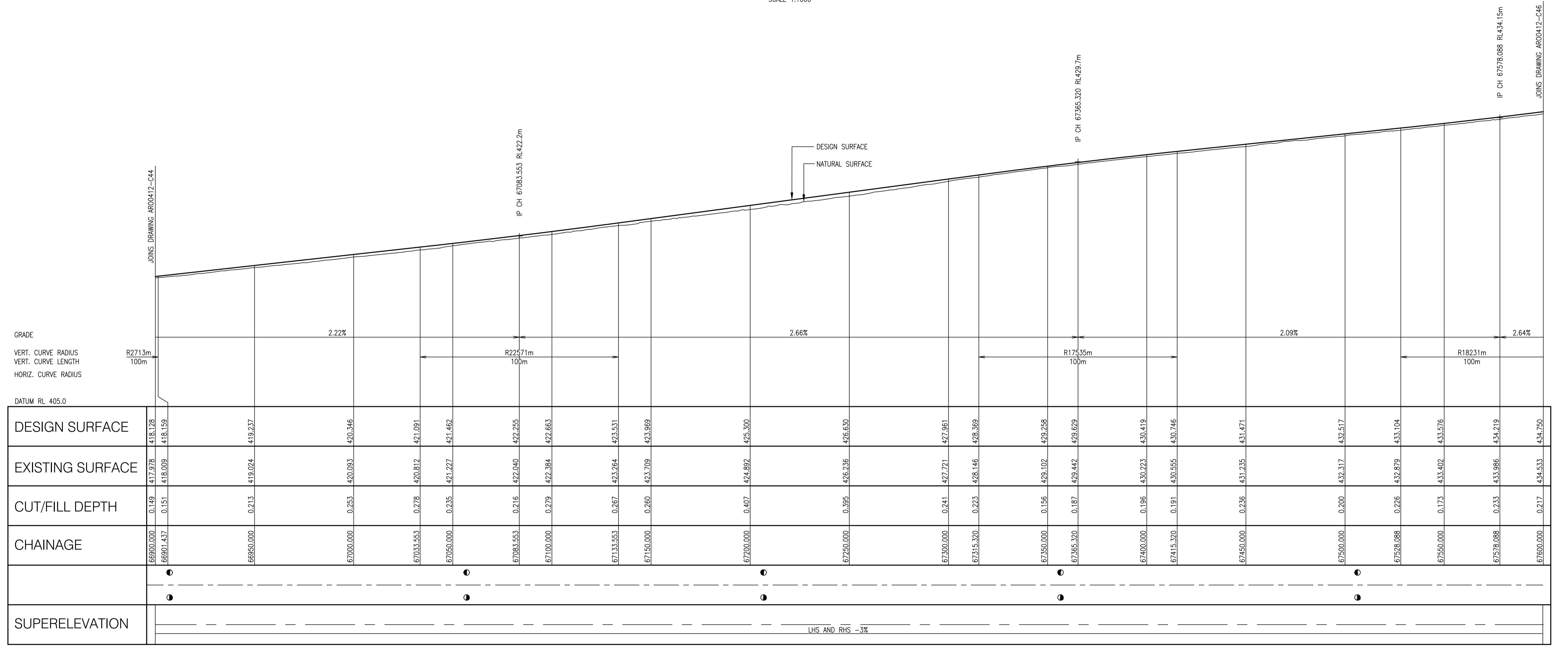

DESIGN CONTROL LINE LONGITUDINAL SECTION
SCALE 1:1000 HOR, 1:200 VERT

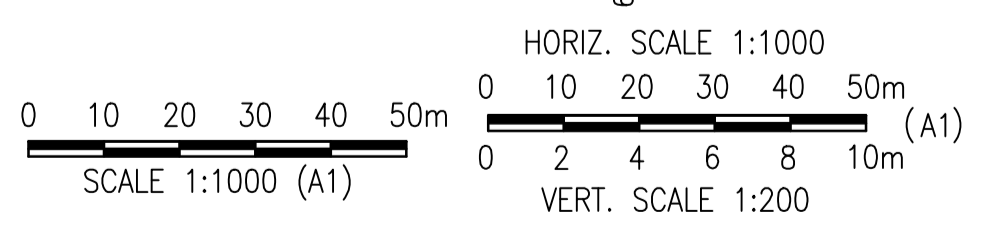

NOTES
1. REFER TO DRAWING ARO0412-C49 FOR LEGEND AND ARO0412-C01 FOR NOTES.
TENDER ISSUE ONLY

No.	Description	Reviewed	Approved	Date
1	TENDER ISSUE ONLY	-	-	23/08/2024



Client: BANANA SHIRE COUNCIL
Project: DEFENCE ROAD UPGRADE - CH 36,172 - CH68,499
Title: WORKING PLAN - SHEET 45 OF 47
Drawing No.: ARO0412-C46

Drawn	Designed	Approved	Scale (A1 size)
MS	MS		AS SHOWN
Drawing Check	Design Check	RPEQ	Date

51 Sheridan Street
Cairns Qld 4870
T (07) 4281 6897
E admin@aroindustries.com.au
W www.aroindustries.com.au
ABN: 49 641 461 298

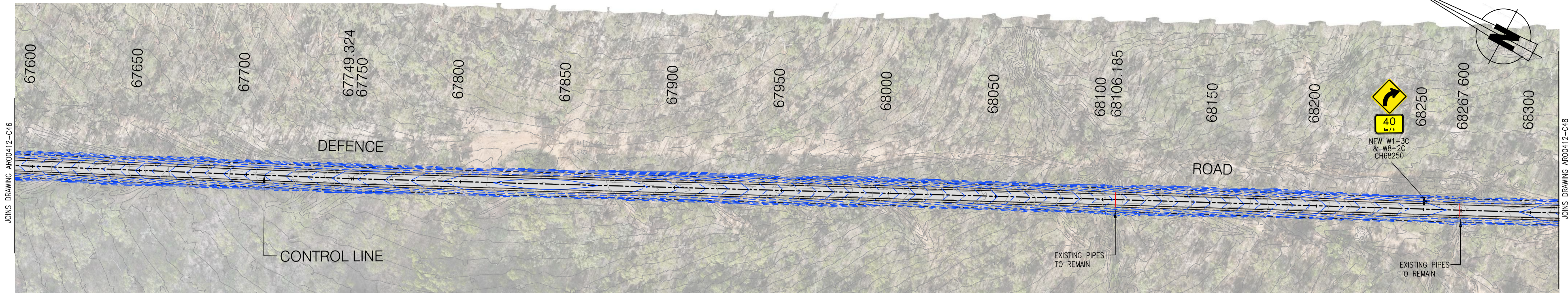

PLAN
SCALE 1:1000

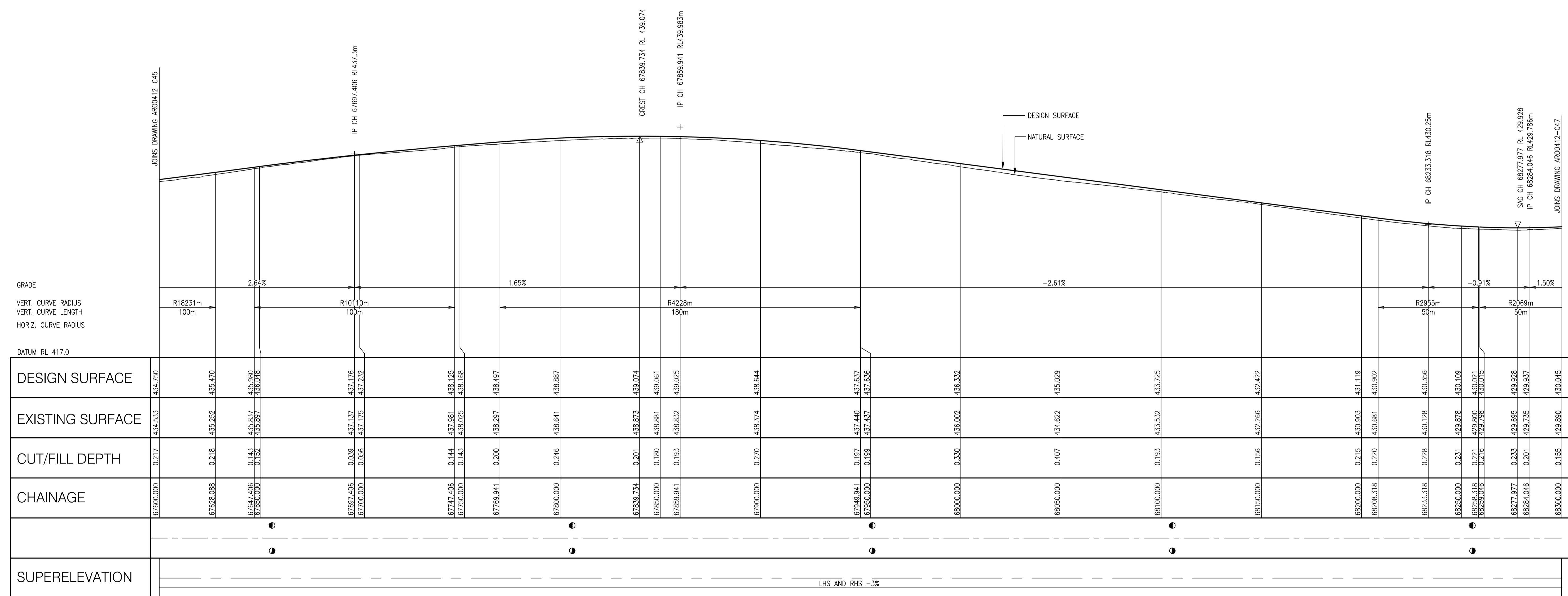

DESIGN CONTROL LINE LONGITUDINAL SECTION
SCALE 1:1000 HOR, 1:200 VERT

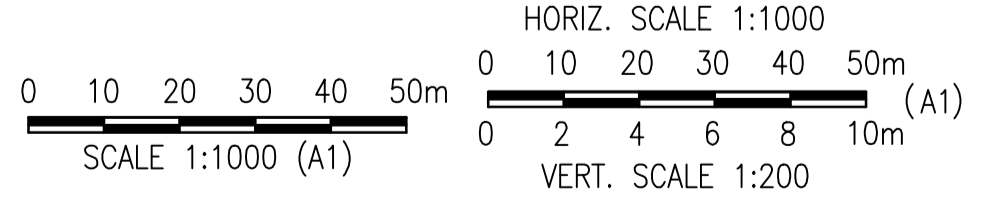

NOTES
1. REFER TO DRAWING ARO0412-C49 FOR LEGEND AND ARO0412-C01 FOR NOTES.

TENDER ISSUE ONLY

No.	Description	Reviewed	Approved	Date
1	TENDER ISSUE ONLY	-	-	23/08/2024



Client: BANANA SHIRE COUNCIL
Project: DEFENCE ROAD UPGRADE - CH 36,172 - CH68,499
Title: WORKING PLAN - SHEET 46 OF 47
Drawing No.: ARO0412-C47

Drawn	Designed	Approved	Scale (A1 size)
MS	MS		AS SHOWN
Drawing Check	Design Check	RPEQ	Date

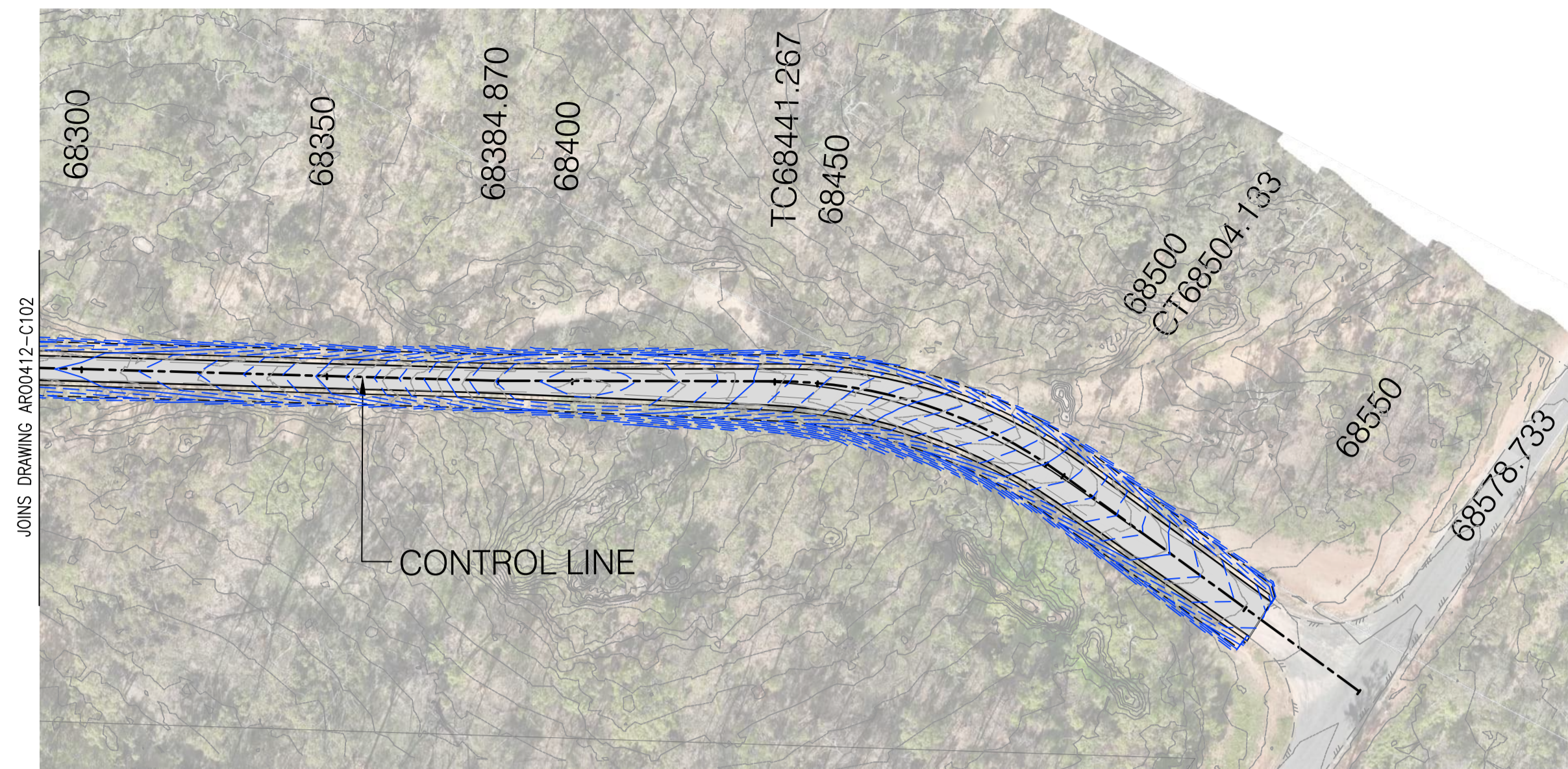

PLAN
SCALE 1:1000

LEGEND

- EXISTING SURFACE CONTOUR (0.1m INTERVAL)
- NEW BITUMEN SEALED ROAD
- PROPOSED SIGN
- GUIDE POST
- DRAIN INVERT
- EXISTING FENCE
- EDGE OF EXISTING VEGETATION

LINEMARKING DIMENSIONS TABLE

TYPE (FROM AS1742.2)	DESCRIPTION	LENGTH (mm)	GAP (mm)	WIDTH (mm)
LL4	SINGLE CONTINUOUS LANE LINE	-	-	100

LINEMARKING (WHITE PAINT) AND SIGNAGE TO BE IN ACCORDANCE WITH AS1742.2 - 'MANUAL OF UNIFORM TRAFFIC CONTROL DEVICES'.

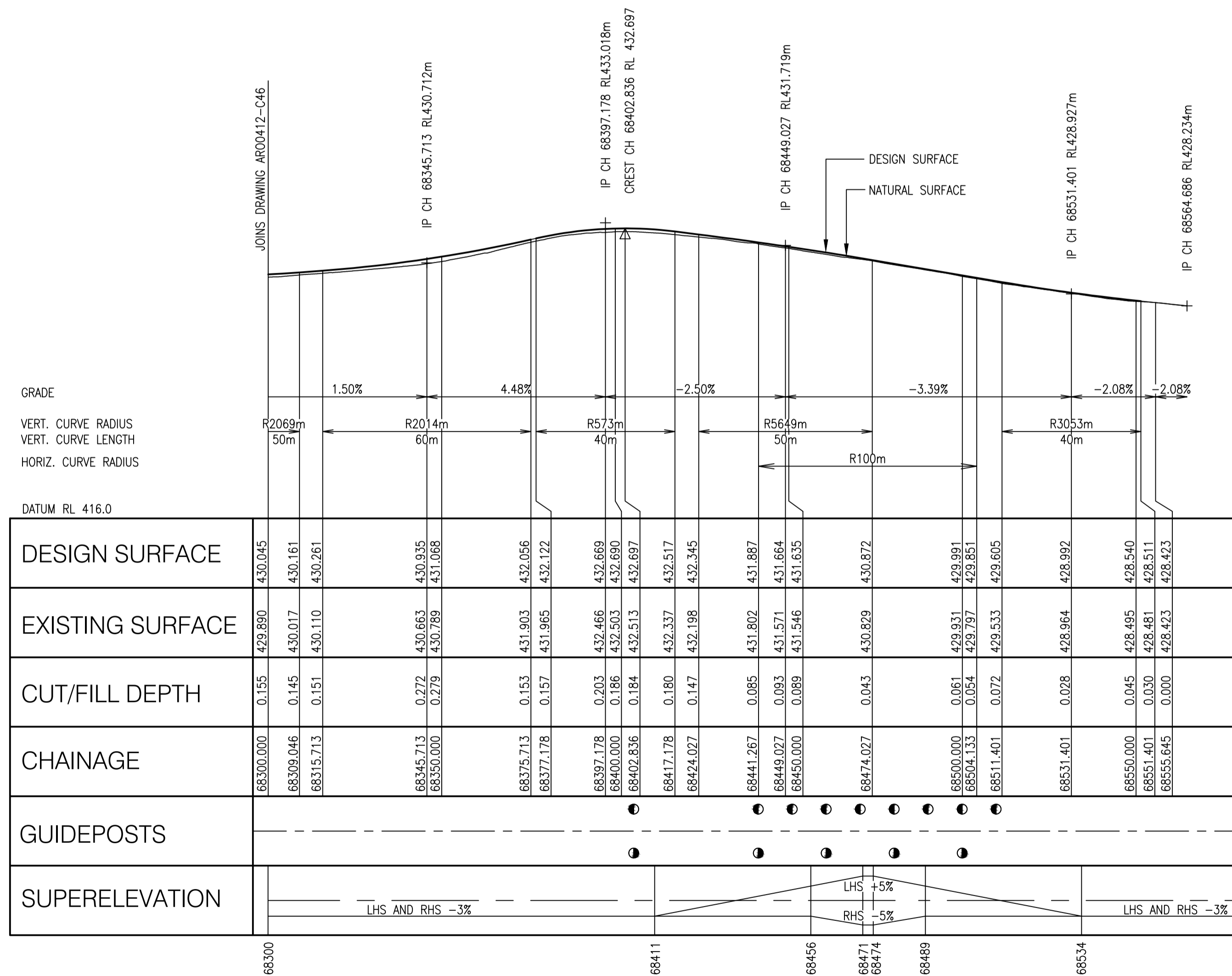

DESIGN CONTROL LINE LONGITUDINAL SECTION
SCALE 1:1000 HOR, 1:200 VERT

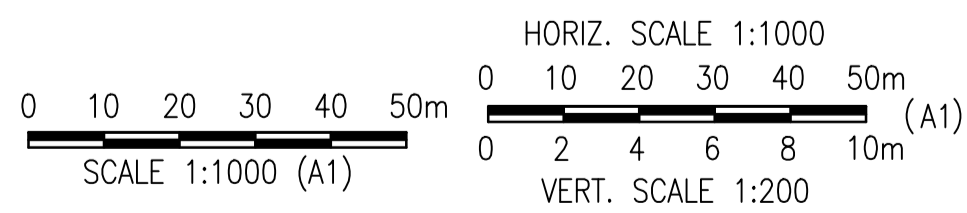

NOTES

- REFER TO DRAWING ARO0412-C49 FOR LEGEND AND ARO0412-C01 FOR NOTES.

TENDER ISSUE ONLY

No.	Description	Reviewed	Approved	Date
1	TENDER ISSUE ONLY	-	-	23/08/2024



Client	BANANA SHIRE COUNCIL
Project	DEFENCE ROAD UPGRADE - CH 36,172 - CH68,499
Title	WORKING PLAN - SHEET 47 OF 47

Drawn	MS	Designed	MS	Approved		Scale (A1 size)	AS SHOWN
Drawing Check		Design Check		RPEQ	Date	Drawing is not to be used for construction unless approved.	

CENTRELINE SETOUT
E 240380.337
N 7227021.689
RL 369.357

DATUM RL 366.0

DESIGN SURFACE LEVEL									
NATURAL SURFACE LEVEL									
DESIGN OFFSET	-6.105	-5.500	-3.500	-2.500	0.000	2.500	3.500	5.500	6.762

CH 36850

CENTRELINE SETOUT
E 240346.442
N 7227058.446
RL 371.823

DATUM RL 369.0

DESIGN SURFACE LEVEL									
NATURAL SURFACE LEVEL									
DESIGN OFFSET	-6.064	-5.500	-3.500	-2.500	0.000	2.500	3.500	5.500	6.624

CH 36800

CENTRELINE SETOUT
E 240312.546
N 7227095.203
RL 374.712

DATUM RL 371.0

DESIGN SURFACE LEVEL									
NATURAL SURFACE LEVEL									
DESIGN OFFSET	-6.042	-5.500	-3.500	-2.500	0.000	2.500	3.500	5.500	6.128

CH 36750

CENTRELINE SETOUT
E 240278.651
N 7227131.96
RL 376.977

DATUM RL 373.0

DESIGN SURFACE LEVEL									
NATURAL SURFACE LEVEL									
DESIGN OFFSET	-8.825	-5.500	-3.500	-2.500	0.000	2.500	3.500	5.500	6.823

CH 36700

CENTRELINE SETOUT
E 240549.836
N 7226837.922
RL 363.336

DATUM RL 360.0

DESIGN SURFACE LEVEL									
NATURAL SURFACE LEVEL									
DESIGN OFFSET	-5.763	-5.500	-3.500	-2.500	0.000	2.500	3.500	5.500	6.704

CH 37100

CENTRELINE SETOUT
E 240482.024
N 7226911.418
RL 364.292

DATUM RL 361.0

DESIGN SURFACE LEVEL									
NATURAL SURFACE LEVEL									
DESIGN OFFSET	-5.889	-5.500	-3.500	-2.500	0.000	2.500	3.500	5.500	6.098

CH 37000

CENTRELINE SETOUT
E 240448.129
N 7226948.175
RL 365.484

DATUM RL 362.0

DESIGN SURFACE LEVEL									
NATURAL SURFACE LEVEL									
DESIGN OFFSET	-5.828	-5.500	-3.500	-2.500	0.000	2.500	3.500	5.500	6.487

CH 36950

CENTRELINE SETOUT
E 240414.233
N 7226984.932
RL 367.254

DATUM RL 364.0

DESIGN SURFACE LEVEL									
NATURAL SURFACE LEVEL									
DESIGN OFFSET	-6.054	-5.500	-3.500	-2.500	0.000	2.500	3.500	5.500	6.800

CH 36900

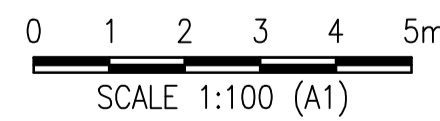

TENDER ISSUE ONLY

No.	Description	Reviewed	Approved	Date
1	TENDER ISSUE	-	-	23/08/2024



Client	BANANA SHIRE COUNCIL
Project	DEFENCE ROAD UPGRADE - CH 36,172 - CH68,499
Title	ANNOTATED CROSS SECTIONS SHEET 2 OF 64
Drawing No.	ARO0400-C51

Drawn	MS	Designed	MS	Approved	RPEQ	Date
Drawing Check		Design Check				

Scale (A1 size)	1:100
Drawing is not to be used for construction unless approved.	



51 Sheridan Street
Cairns Qld 4870
T (07) 4281 6897
E admin@arindustries.com.au
W www.arindustries.com.au
ABN: 49 641 461 298

CENTRELINE SETOUT
E 240719.387
N 7226654.204
RL 359.173

DATUM RL 356.0

DESIGN SURFACE LEVEL										
NATURAL SURFACE LEVEL										
DESIGN OFFSET										

CH 37350

CENTRELINE SETOUT
E 240685.477
N 7226890.947
RL 359.737

DATUM RL 357.0

DESIGN SURFACE LEVEL										
NATURAL SURFACE LEVEL										
DESIGN OFFSET										

CH 37300

CENTRELINE SETOUT
E 240617.657
N 7226764.435
RL 362.081

DATUM RL 359.0

DESIGN SURFACE LEVEL										
NATURAL SURFACE LEVEL										
DESIGN OFFSET										

CH 37200

CENTRELINE SETOUT
E 240583.747
N 7226801.179
RL 362.906

DATUM RL 360.0

DESIGN SURFACE LEVEL										
NATURAL SURFACE LEVEL										
DESIGN OFFSET										

CH 37150

CENTRELINE SETOUT
E 240922.848
N 7226433.741
RL 359.305

DATUM RL 356.0

DESIGN SURFACE LEVEL										
NATURAL SURFACE LEVEL										
DESIGN OFFSET										

CH 37650

CENTRELINE SETOUT
E 240888.936
N 7226470.485
RL 360.362

DATUM RL 357.0

DESIGN SURFACE LEVEL										
NATURAL SURFACE LEVEL										
DESIGN OFFSET										

CH 37600

CENTRELINE SETOUT
E 240821.117
N 7226543.972
RL 362.047

DATUM RL 359.0

DESIGN SURFACE LEVEL										
NATURAL SURFACE LEVEL										
DESIGN OFFSET										

CH 37500

CENTRELINE SETOUT
E 240753.297
N 7226617.46
RL 360.195

DATUM RL 357.0

DESIGN SURFACE LEVEL										
NATURAL SURFACE LEVEL										
DESIGN OFFSET										

CH 37400

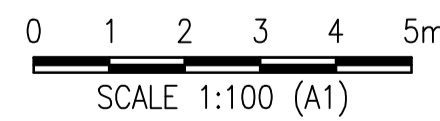

TENDER ISSUE ONLY

No.	Description	Reviewed	Approved	Date
1	TENDER ISSUE			23/08/2024



Client	BANANA SHIRE COUNCIL
Project	DEFENCE ROAD UPGRADE - CH 36,172 - CH68,499
Title	ANNOTATED CROSS SECTIONS SHEET 3 OF 64

Drawn	MS	Designed	MS	Approved		Scale (A1 size)	1:100
Drawing Check		Design Check		RPEQ	Date	Drawing is not to be used for construction unless approved.	



51 Sheridan Street
Cairns Qld 4870
T (07) 4281 6897
E admin@arindustries.com.au
W www.arindustries.com.au
ABN: 49 641 461 298

CENTRELINE SETOUT
E 241364.998
N 7225837.269
RL 364.972

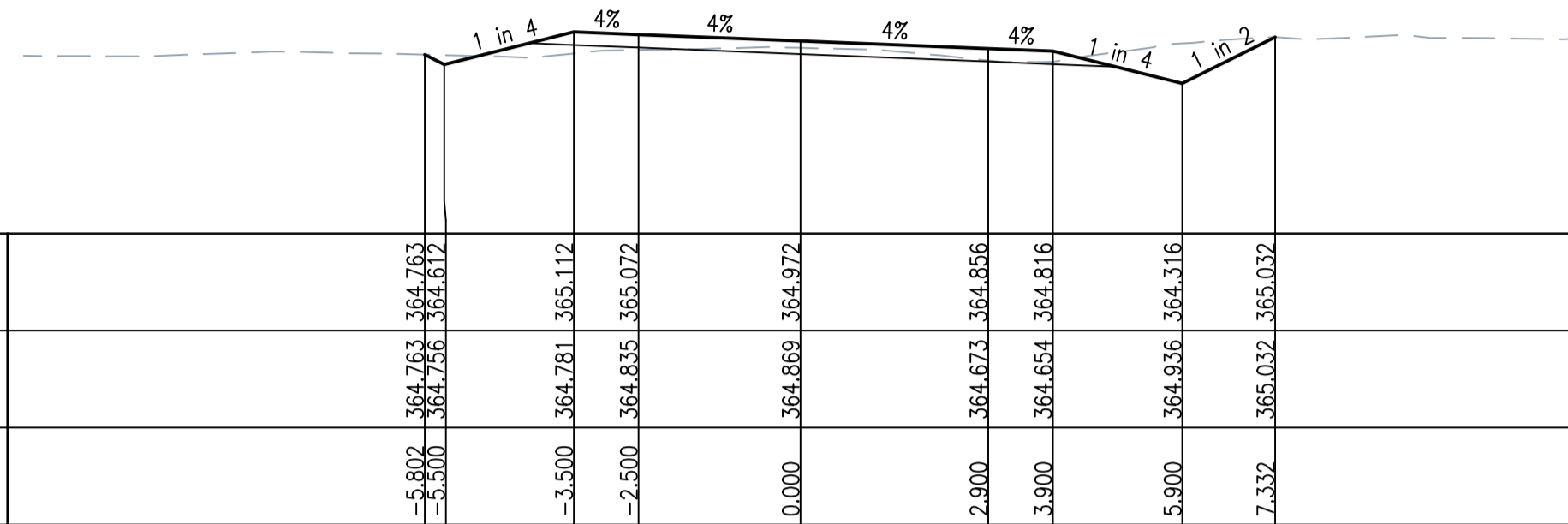

DATUM RL 362.0

DESIGN SURFACE LEVEL										
NATURAL SURFACE LEVEL										
DESIGN OFFSET										

CH 38400

CENTRELINE SETOUT
E 241328.541
N 7225930.364
RL 364.206

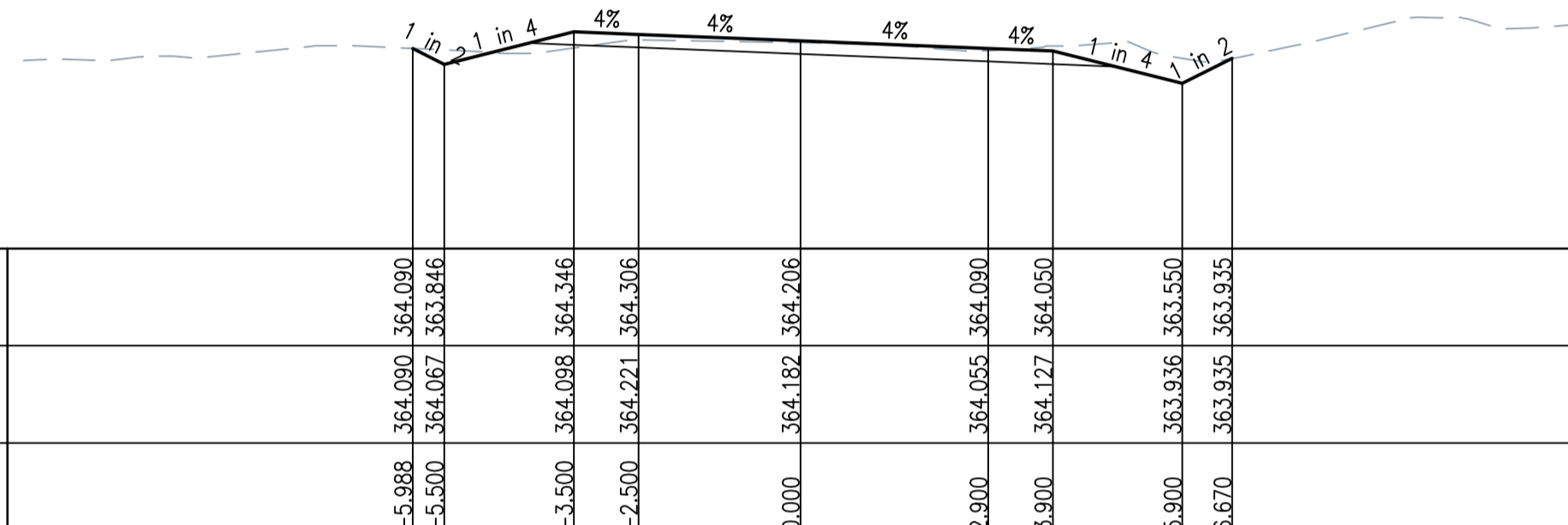

DATUM RL 361.0

DESIGN SURFACE LEVEL										
NATURAL SURFACE LEVEL										
DESIGN OFFSET										

CH 38300

CENTRELINE SETOUT
E 241282.635
N 7226019.139
RL 362.547

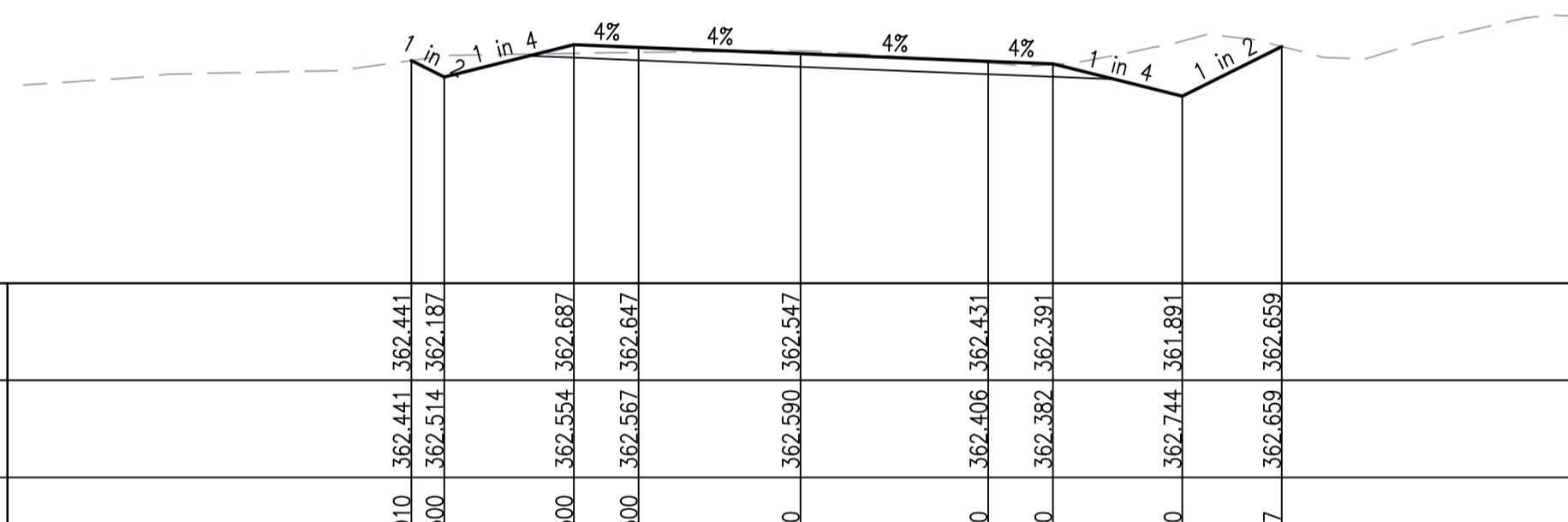

DATUM RL 359.0

DESIGN SURFACE LEVEL										
NATURAL SURFACE LEVEL										
DESIGN OFFSET										

CH 38200

CENTRELINE SETOUT
E 241255.848
N 7226061.35
RL 361.718

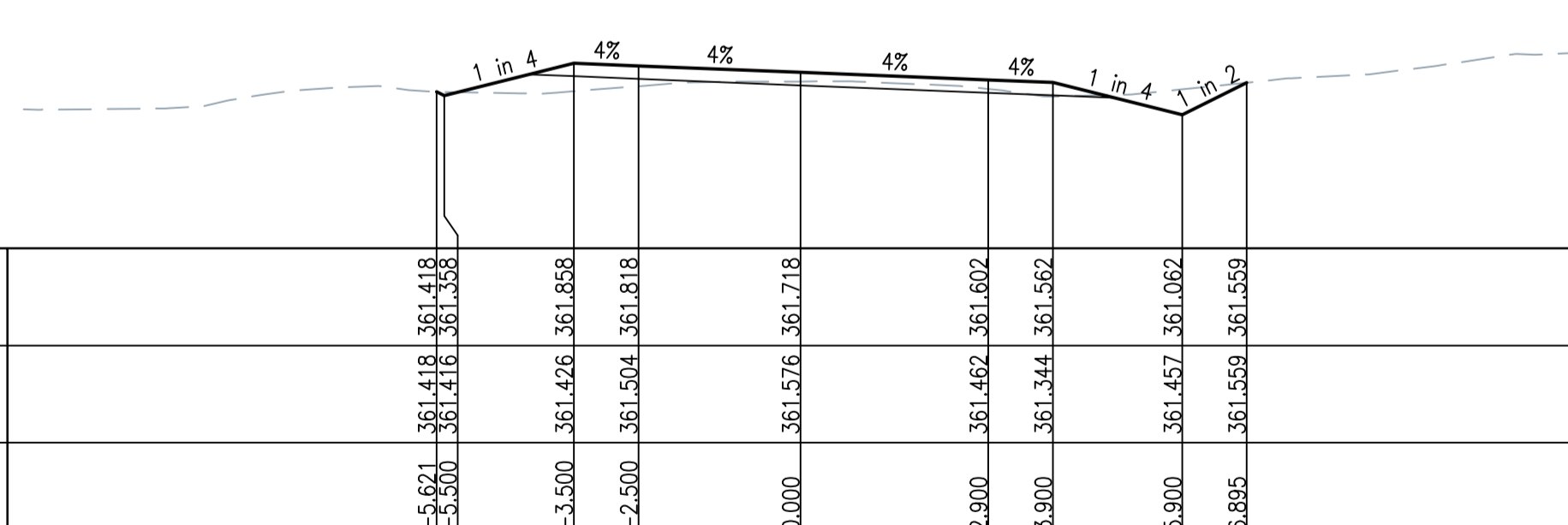

DATUM RL 359.0

DESIGN SURFACE LEVEL										
NATURAL SURFACE LEVEL										
DESIGN OFFSET										

CH 38150

CENTRELINE SETOUT
E 241432.38
N 7225645.197
RL 364.289

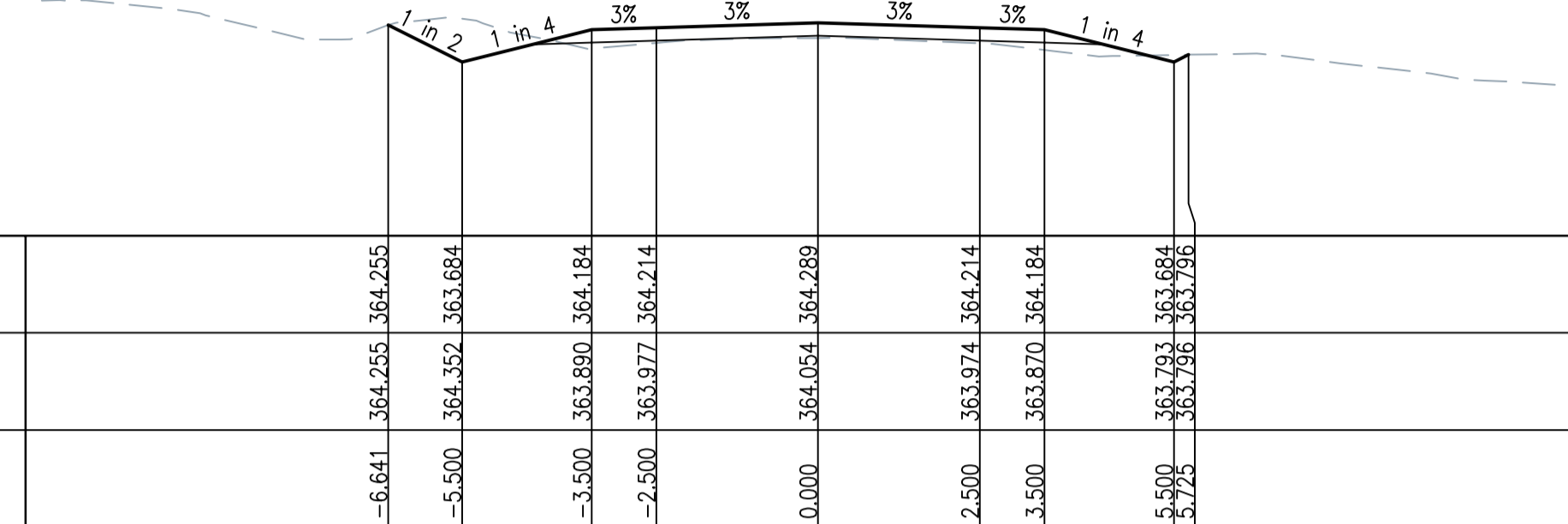

DATUM RL 361.0

DESIGN SURFACE LEVEL										
NATURAL SURFACE LEVEL										
DESIGN OFFSET										

CH 38700

CENTRELINE SETOUT
E 241412.478
N 7225643.196
RL 363.89

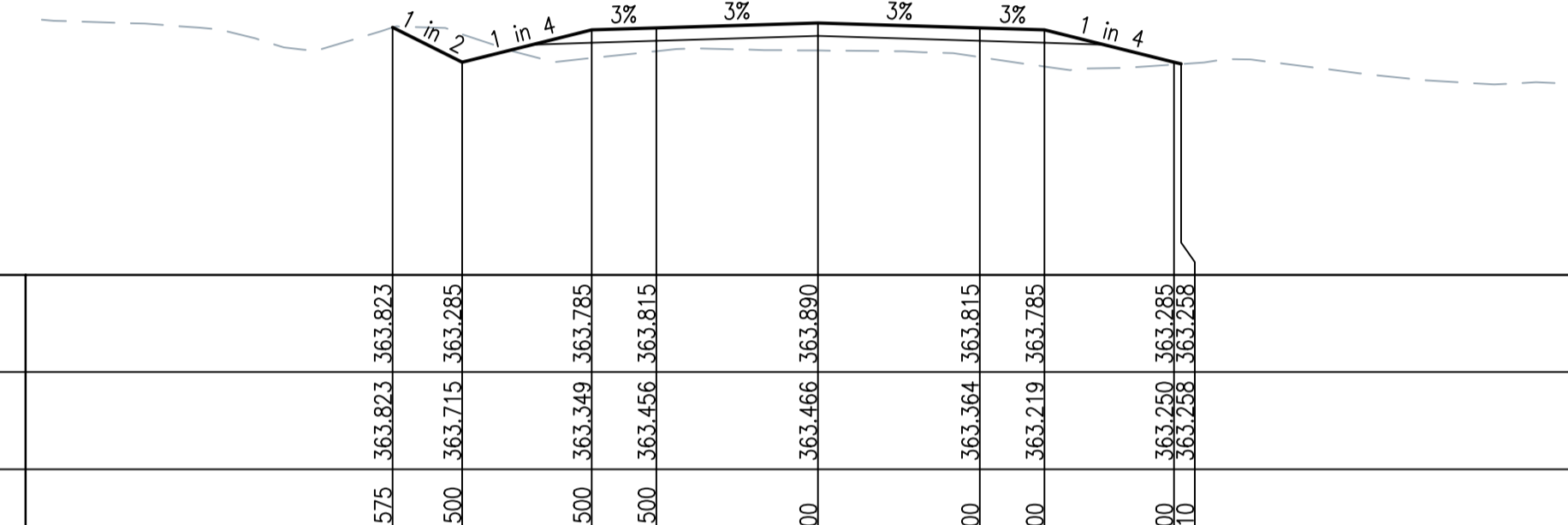

DATUM RL 360.0

DESIGN SURFACE LEVEL										
NATURAL SURFACE LEVEL										
DESIGN OFFSET										

CH 38600

CENTRELINE SETOUT
E 241402.527
N 7225692.196
RL 363.723

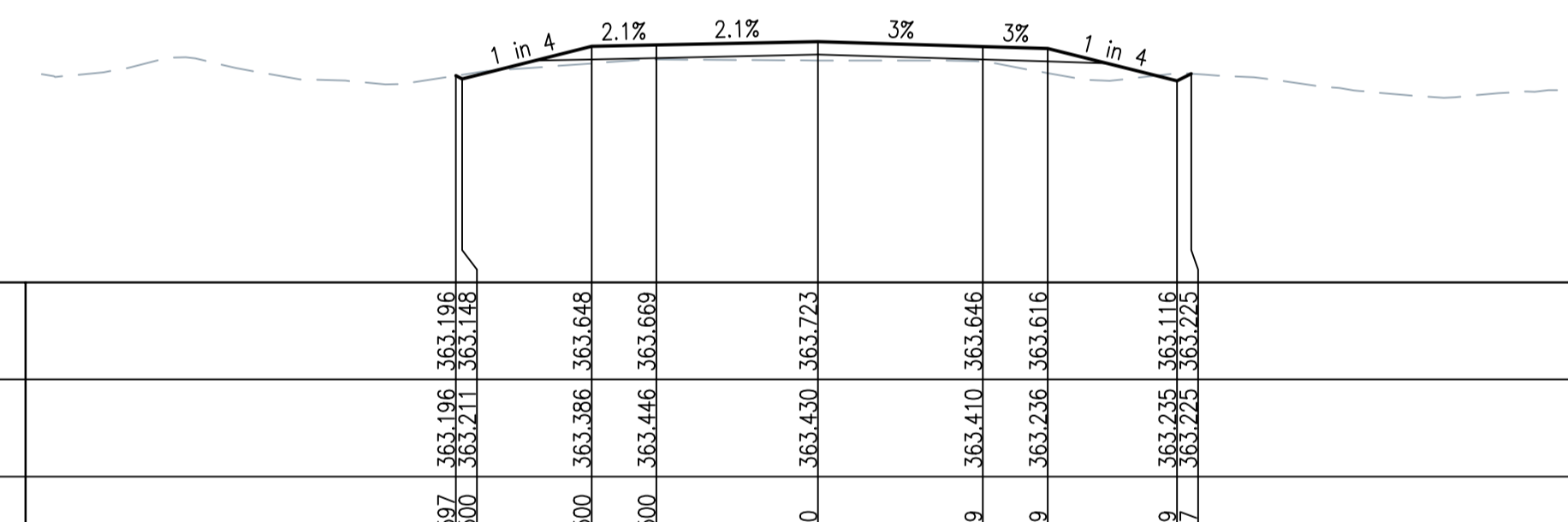

DATUM RL 360.0

DESIGN SURFACE LEVEL										
NATURAL SURFACE LEVEL										
DESIGN OFFSET										

CH 38550

CENTRELINE SETOUT
E 241392.428
N 7225741.165
RL 363.972

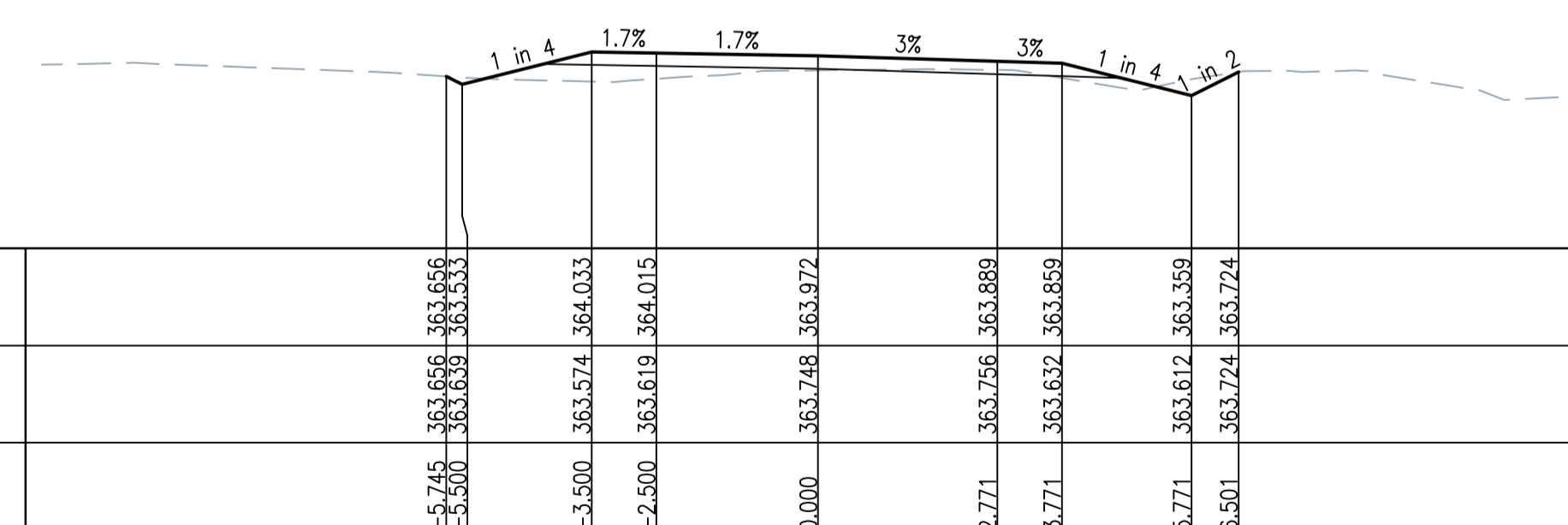

DATUM RL 361.0

DESIGN SURFACE LEVEL										
NATURAL SURFACE LEVEL										
DESIGN OFFSET										

CH 38500

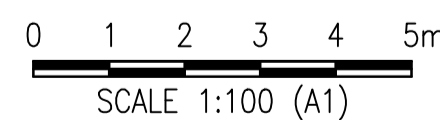

TENDER ISSUE ONLY

No.	Description	Reviewed	Approved	Date
1	TENDER ISSUE	-	-	23/08/2024



Client	BANANA SHIRE COUNCIL
Project	DEFENCE ROAD UPGRADE - CH 36,172 - CH68,499
Title	ANNOTATED CROSS SECTIONS SHEET 5 OF 64
Drawing No.	ARO0400-C54

Drawn	MS	Designed	MS	Approved		Scale (A1 size)	1:100
Drawing Check		Design Check	RPEQ	Date		Drawing is not to be used for construction unless approved.	

CENTRELINE SETOUT
E 241618.924
N 7224767.69
RL 351.643

DATUM RL 347.0

DESIGN SURFACE LEVEL									
NATURAL SURFACE LEVEL									
DESIGN OFFSET									

CH 39500

CENTRELINE SETOUT
E 241590.941
N 7224863.694
RL 353.558

DATUM RL 350.0

DESIGN SURFACE LEVEL									
NATURAL SURFACE LEVEL									
DESIGN OFFSET									

CH 39400

CENTRELINE SETOUT
E 241562.975
N 7224959.704
RL 355.472

DATUM RL 352.0

DESIGN SURFACE LEVEL									
NATURAL SURFACE LEVEL									
DESIGN OFFSET									

CH 39300

CENTRELINE SETOUT
E 241549.866
N 7225007.954
RL 356.429

DATUM RL 353.0

DESIGN SURFACE LEVEL									
NATURAL SURFACE LEVEL									
DESIGN OFFSET									

CH 39250

CENTRELINE SETOUT
E 241727.43
N 7224382.689
RL 343.618

DATUM RL 340.0

DESIGN SURFACE LEVEL									
NATURAL SURFACE LEVEL									
DESIGN OFFSET									

CH 39900

CENTRELINE SETOUT
E 241700.351
N 7224478.953
RL 345.68

DATUM RL 342.0

DESIGN SURFACE LEVEL									
NATURAL SURFACE LEVEL									
DESIGN OFFSET									

CH 39800

CENTRELINE SETOUT
E 241673.273
N 7224575.216
RL 347.742

DATUM RL 345.0

DESIGN SURFACE LEVEL									
NATURAL SURFACE LEVEL									
DESIGN OFFSET									

CH 39700

CENTRELINE SETOUT
E 241646.194
N 7224671.48
RL 349.729

DATUM RL 346.0

DESIGN SURFACE LEVEL									
NATURAL SURFACE LEVEL									
DESIGN OFFSET									

CH 39600

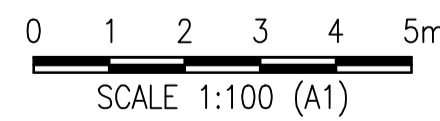

No.	Description	Reviewed	Approved	Date
1	TENDER ISSUE			23/08/2024



Client	BANANA SHIRE COUNCIL
Project	DEFENCE ROAD UPGRADE - CH 36,172 - CH68,499
Title	ANNOTATED CROSS SECTIONS SHEET 7 OF 64

Drawn	MS	Designed	MS	Approved	
Drawing Check		Design Check		RPEQ	Date

Scale (A1 size)
1:100

Drawing is not to be used for construction unless approved.

51 Sheridan Street
Cairns Qld 4870
T (07) 4281 6897
E admin@arindustries.com.au
W www.arindustries.com.au
ABN: 49 641 461 298

CENTRELINE SETOUT
E 241781.588
N 7224190.161
RL 345.429

DESIGN SURFACE LEVEL	345.211	345.211	344.824	345.324	345.354	345.212	345.212	345.354	345.324	344.824	344.828
NATURAL SURFACE LEVEL											
DESIGN OFFSET	-6.274	-5.500	-3.500	-2.500	0.000	2.500	3.500	5.500	3.708		

CH 40100

CENTRELINE SETOUT
E 241768.048
N 7224238.293
RL 345.34

DESIGN SURFACE LEVEL	345.766	344.735	345.235	345.265	345.340	345.265	345.265	344.735	344.942
NATURAL SURFACE LEVEL									
DESIGN OFFSET	-7.551	-5.500	-3.500	-2.500	0.000	2.500	3.500	5.500	5.313

CH 40050

CENTRELINE SETOUT
E 241754.509
N 7224286.425
RL 344.252

DESIGN SURFACE LEVEL	344.874	343.647	344.147	344.177	344.252	344.177	344.147	343.647	343.770
NATURAL SURFACE LEVEL									
DESIGN OFFSET	-7.955	-5.500	-3.500	-2.500	0.000	2.500	3.500	5.500	3.746

CH 40000

CENTRELINE SETOUT
E 241740.969
N 7224334.557
RL 342.957

DESIGN SURFACE LEVEL	342.244	342.352	342.852	342.882	342.957	342.882	342.852	342.352	341.326
NATURAL SURFACE LEVEL									
DESIGN OFFSET	-5.832	-5.500	-3.500	-2.500	0.000	2.500	3.500	5.500	9.604

CH 39950

CENTRELINE SETOUT
E 241835.78
N 7223997.643
RL 341.444

DESIGN SURFACE LEVEL	341.455	340.839	341.339	341.369	341.444	341.369	341.339	340.839	340.839
NATURAL SURFACE LEVEL									
DESIGN OFFSET	-6.732	-5.500	-3.500	-2.500	0.000	2.500	3.500	5.500	3.718

CH 40300

CENTRELINE SETOUT
E 241822.206
N 7224045.765
RL 342.794

DESIGN SURFACE LEVEL	342.390	342.189	342.689	342.719	342.794	342.719	342.689	342.189	342.189
NATURAL SURFACE LEVEL									
DESIGN OFFSET	-5.902	-5.500	-3.500	-2.500	0.000	2.500	3.500	5.500	5.310

CH 40250

CENTRELINE SETOUT
E 241808.666
N 7224093.697
RL 344.582

DESIGN SURFACE LEVEL	344.653	343.977	344.477	344.507	344.582	344.507	344.477	343.977	343.977
NATURAL SURFACE LEVEL									
DESIGN OFFSET	-6.852	-5.500	-3.500	-2.500	0.000	2.500	3.500	5.500	5.988

CH 40200

CENTRELINE SETOUT
E 241795.127
N 7224142.029
RL 345.861

DESIGN SURFACE LEVEL	346.147	345.256	345.756	345.786	345.861	345.786	345.756	345.256	345.256
NATURAL SURFACE LEVEL									
DESIGN OFFSET	-7.281	-5.500	-3.500	-2.500	0.000	2.500	3.500	5.500	6.151

CH 40150

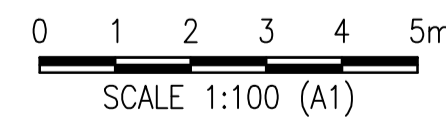

TENDER ISSUE ONLY

No.	Description	Reviewed	Approved	Date
1	TENDER ISSUE	-	-	23/08/2024



Client	BANANA SHIRE COUNCIL
Project	DEFENCE ROAD UPGRADE - CH 36,172 - CH68,499
Title	ANNOTATED CROSS SECTIONS SHEET 8 OF 64

Drawn	MS	Designed	MS	Approved	RPEQ	Scale (A1 size)	1:100
Drawing Check		Design Check		RPEQ	Date	Drawing is not to be used for construction unless approved.	

51 Sheridan Street
Cairns Qld 4870
T (07) 4281 6897
E admin@aroindustries.com.au
W www.aroindustries.com.au
ABN: 49 641 461 298

CENTRELINE SETOUT
E 241904.158
N 7223757.228
RL 335.377

DATUM RL 332.0

DESIGN SURFACE LEVEL										
NATURAL SURFACE LEVEL										
DESIGN OFFSET										

CH 40550

CENTRELINE SETOUT
E 241892.243
N 7223805.779
RL 337.271

DATUM RL 334.0

DESIGN SURFACE LEVEL										
NATURAL SURFACE LEVEL										
DESIGN OFFSET										

CH 40500

CENTRELINE SETOUT
E 241878.19
N 7223853.763
RL 338.905

DATUM RL 336.0

DESIGN SURFACE LEVEL										
NATURAL SURFACE LEVEL										
DESIGN OFFSET										

CH 40450

CENTRELINE SETOUT
E 241864.053
N 7223901.723
RL 340.046

DATUM RL 337.0

DESIGN SURFACE LEVEL										
NATURAL SURFACE LEVEL										
DESIGN OFFSET										

CH 40400

CENTRELINE SETOUT
E 241931.111
N 7223559.174
RL 328.655

DATUM RL 325.0

DESIGN SURFACE LEVEL										
NATURAL SURFACE LEVEL										
DESIGN OFFSET										

CH 40750

CENTRELINE SETOUT
E 241926.635
N 7223608.971
RL 328.941

DATUM RL 326.0

DESIGN SURFACE LEVEL										
NATURAL SURFACE LEVEL										
DESIGN OFFSET										

CH 40700

CENTRELINE SETOUT
E 241920.502
N 7223658.591
RL 330.107

DATUM RL 327.0

DESIGN SURFACE LEVEL										
NATURAL SURFACE LEVEL										
DESIGN OFFSET										

CH 40650

CENTRELINE SETOUT
E 241913.03
N 7223708.029
RL 332.503

DATUM RL 329.0

DESIGN SURFACE LEVEL										
NATURAL SURFACE LEVEL										
DESIGN OFFSET										

CH 40600

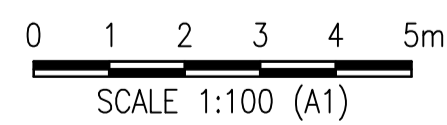

TENDER ISSUE ONLY

No.	Description	Reviewed	Approved	Date
1	TENDER ISSUE	-	-	23/08/2024



Client BANANA SHIRE COUNCIL
Project DEFENCE ROAD UPGRADE - CH 36,172 - CH68,499
Title ANNOTATED CROSS SECTIONS SHEET 9 OF 64

Drawn MS	Designed MS	Approved
Drawing Check	Design Check	RPEQ Date

Scale (A1 size)
1:100
Drawing is not to be used for construction unless approved.



51 Sheridan Street
Cairns Qld 4870
T (07) 4281 6897
E admin@arindustries.com.au
W www.arindustries.com.au
ABN: 49 641 461 298

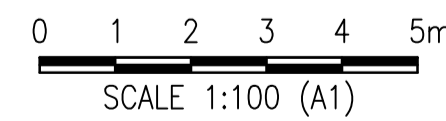
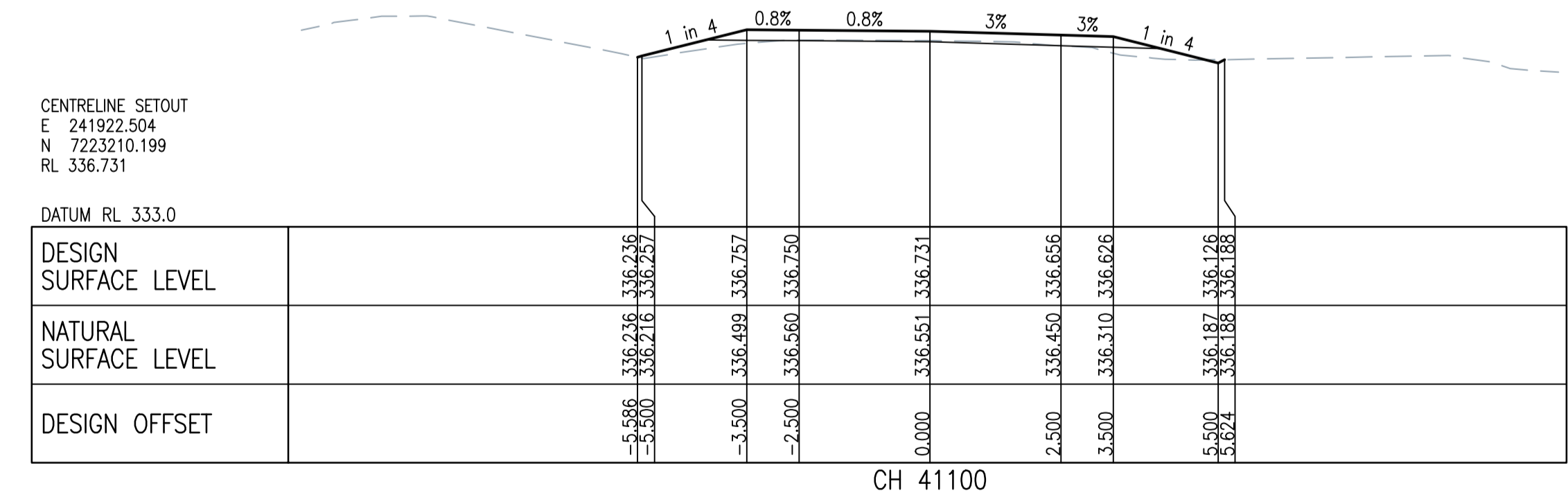
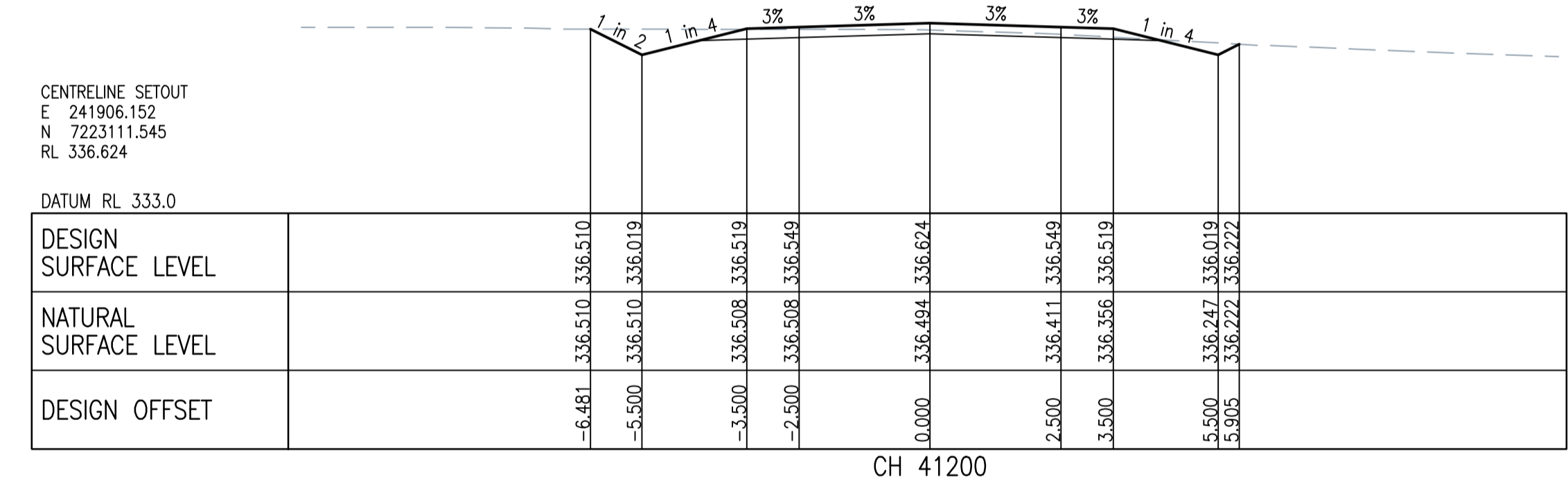
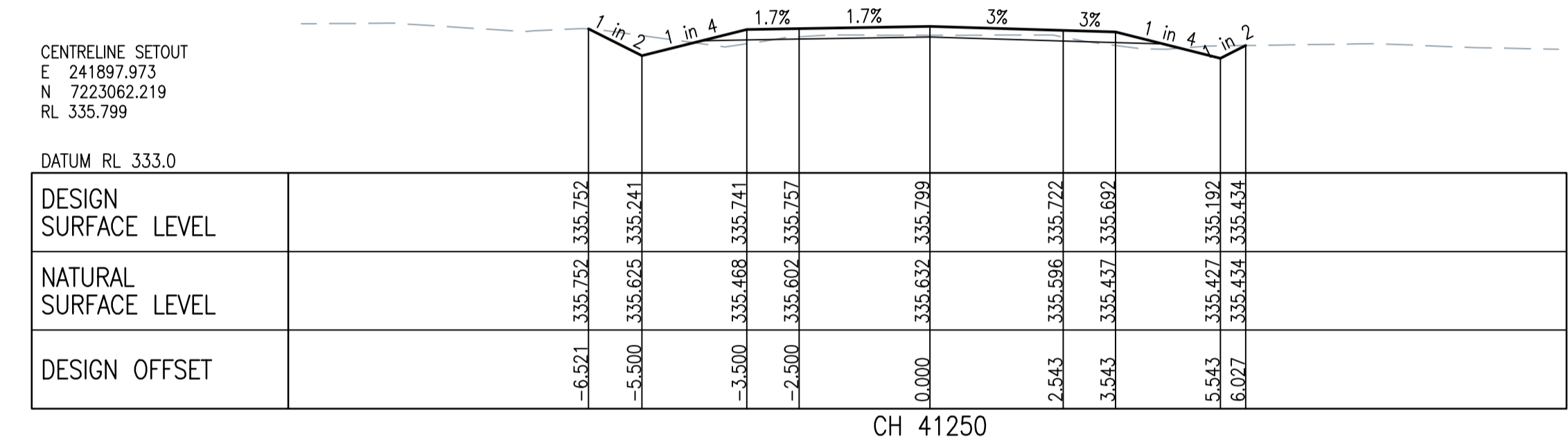
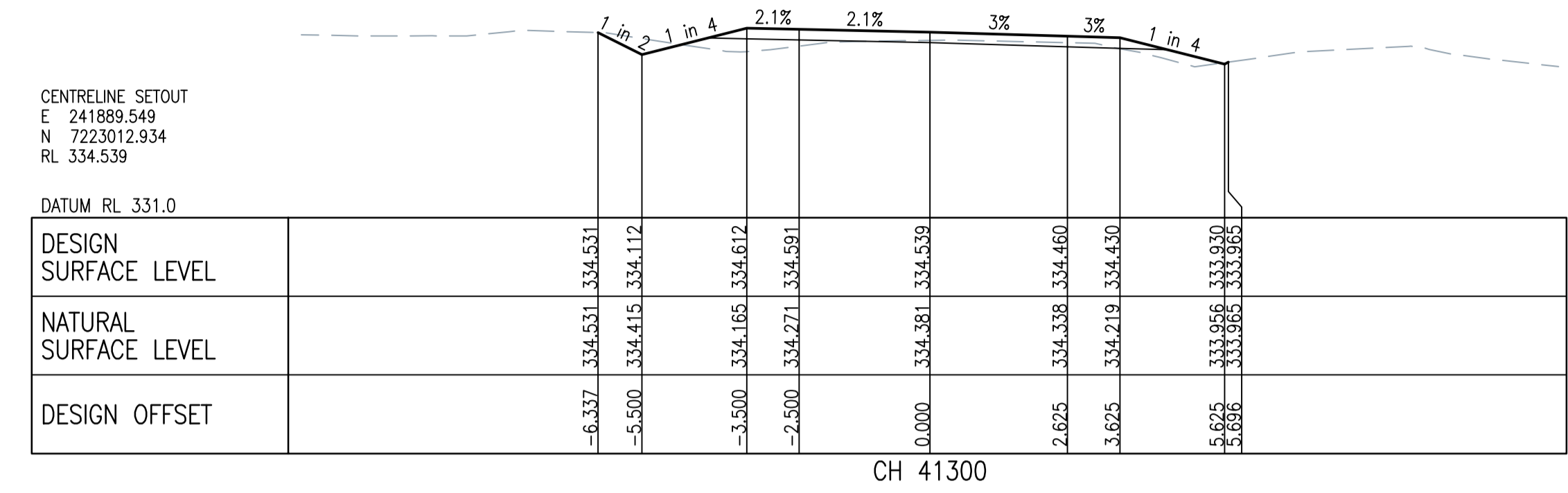
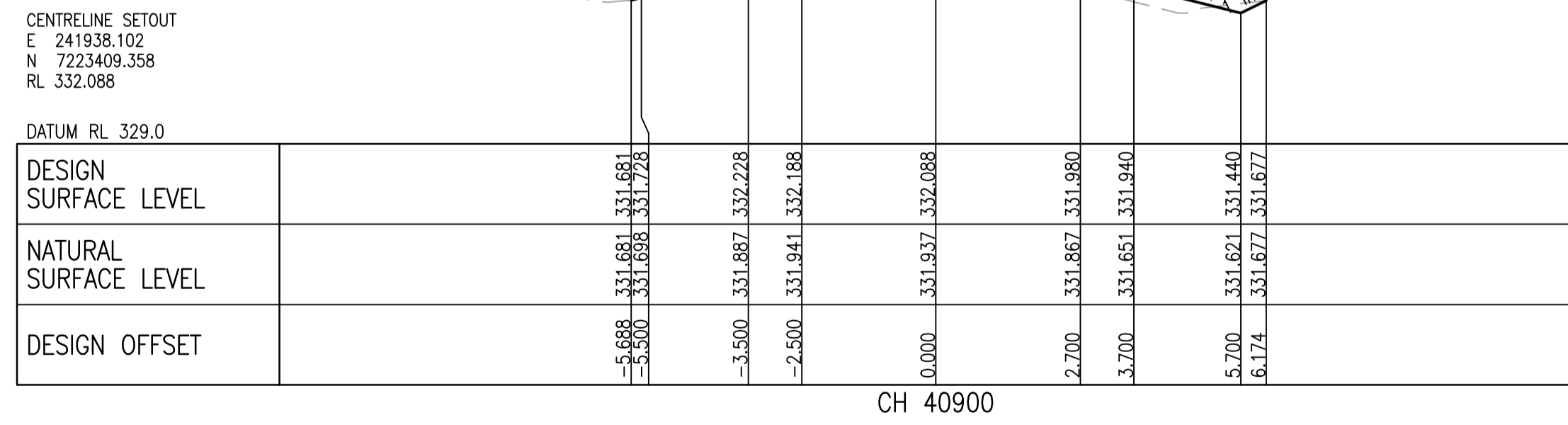
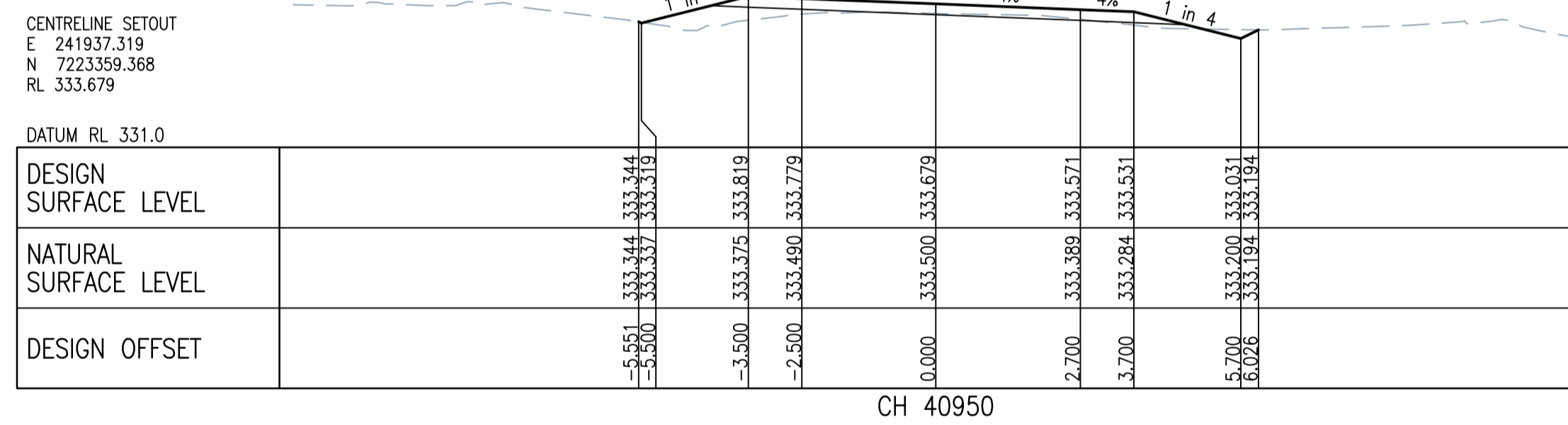
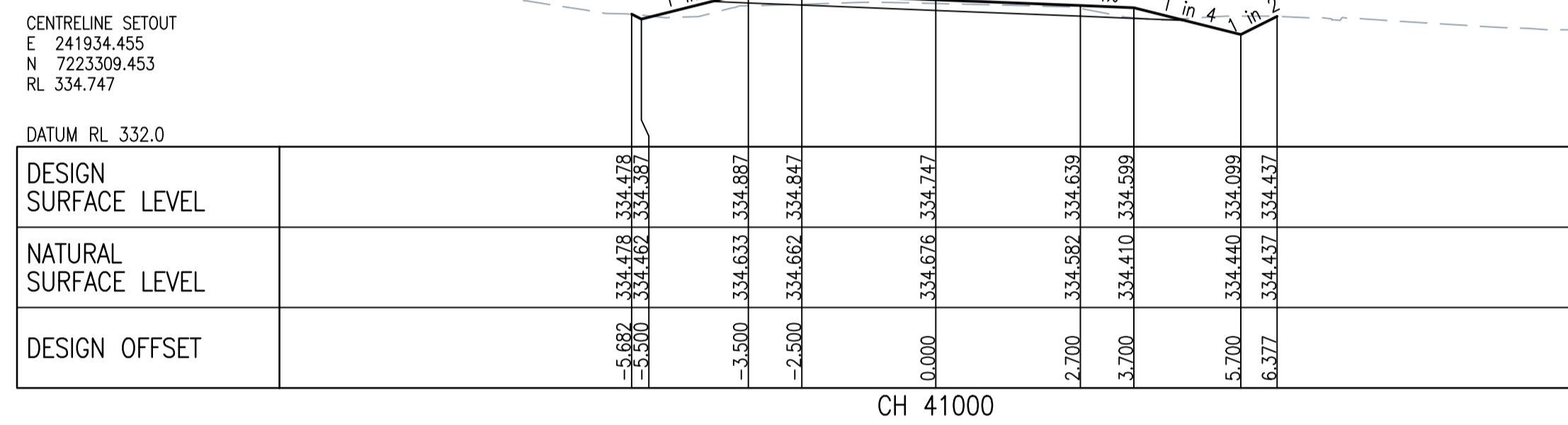

TENDER ISSUE ONLY

No.	Description	Reviewed	Approved	Date
1	TENDER ISSUE	-	-	23/08/2024



Client	BANANA SHIRE COUNCIL
Project	DEFENCE ROAD UPGRADE - CH 36,172 - CH68,499
Title	ANNOTATED CROSS SECTIONS SHEET 10 OF 64

Drawn	MS	Designed	MS	Approved	
Drawing Check		Design Check		RPEQ	Date

Scale (A1 size)
1:100

Drawing is not to be used for construction unless approved.

51 Sheridan Street
Cairns Qld 4870
T (07) 4281 6897
E admin@arindustries.com.au
W www.arindustries.com.au
ABN: 49 641 461 298

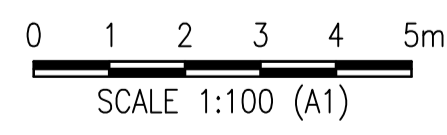
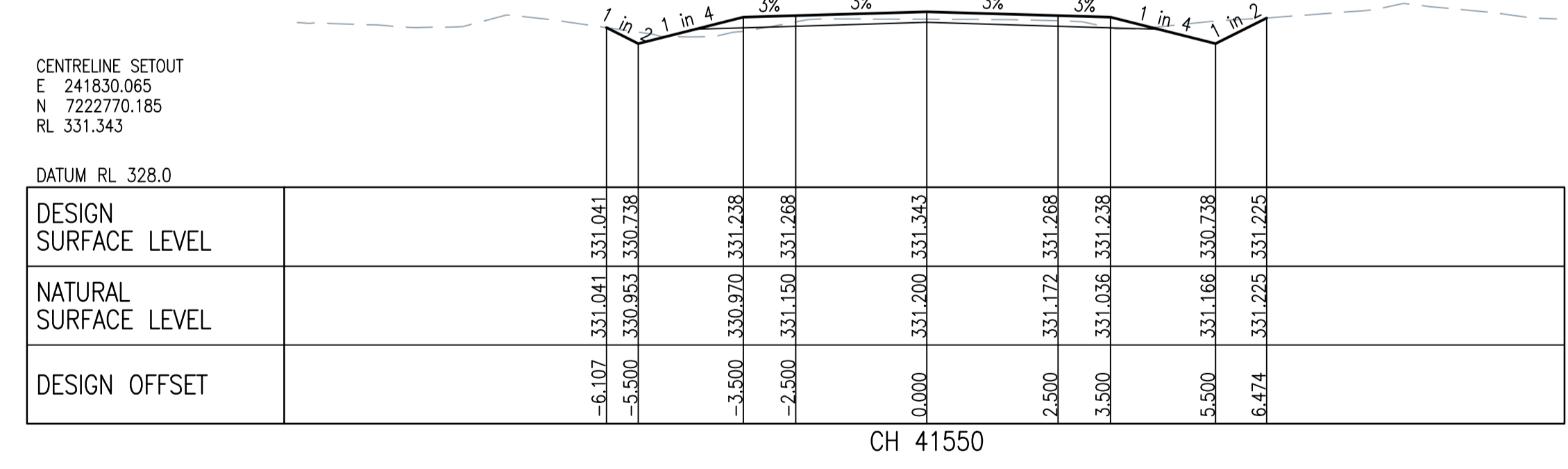
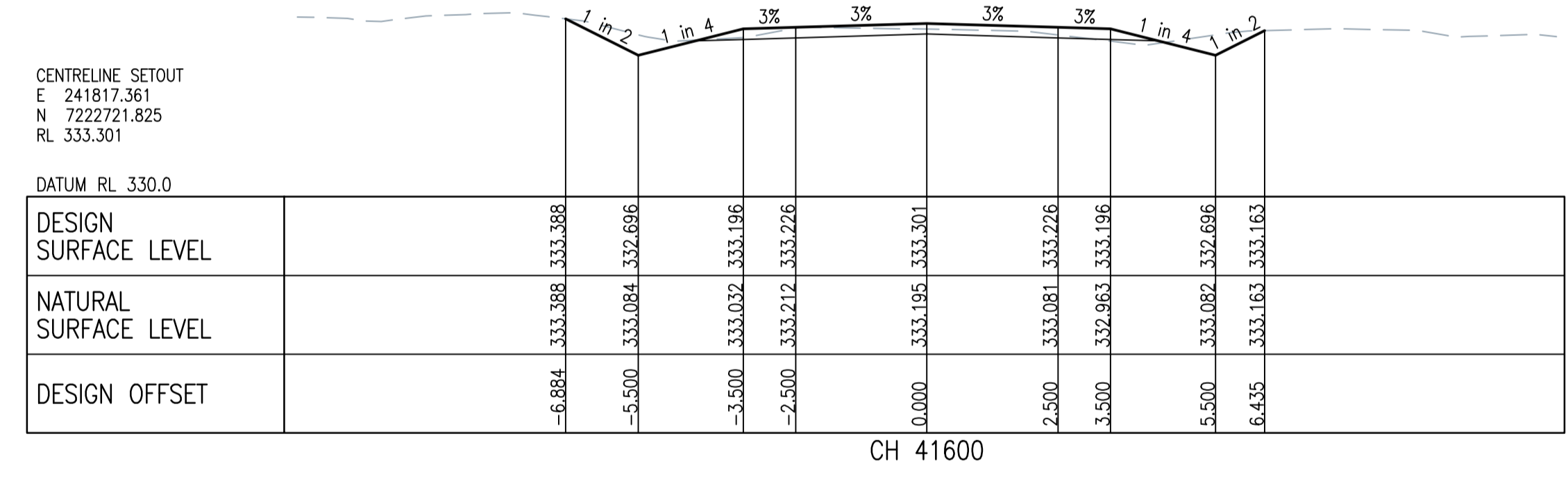
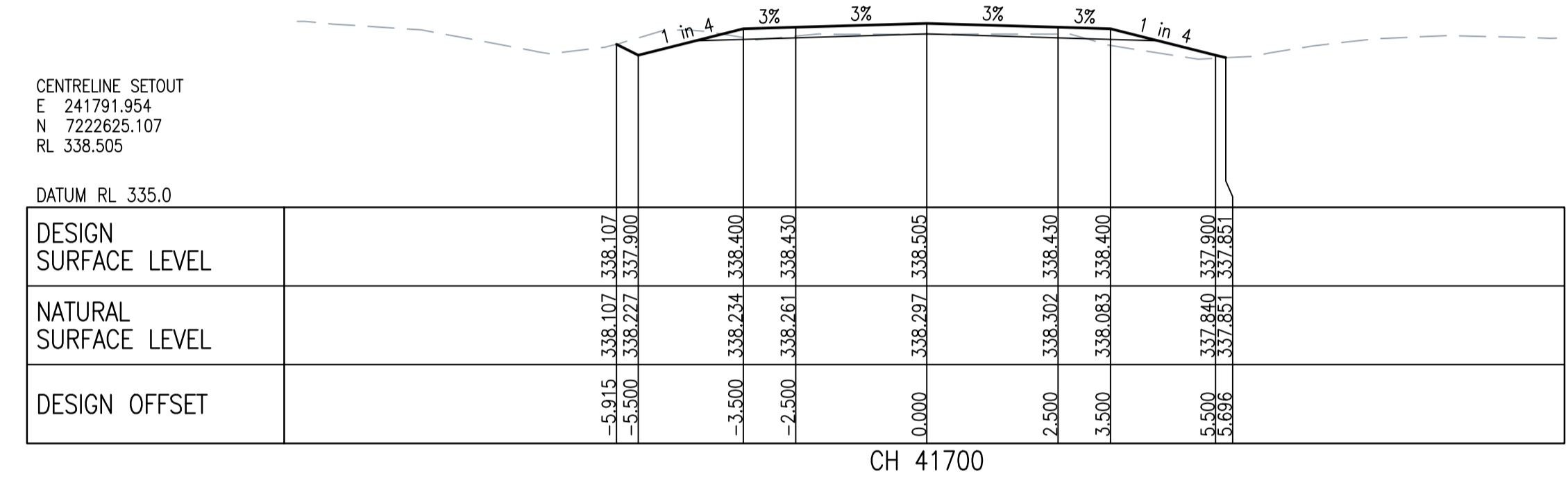
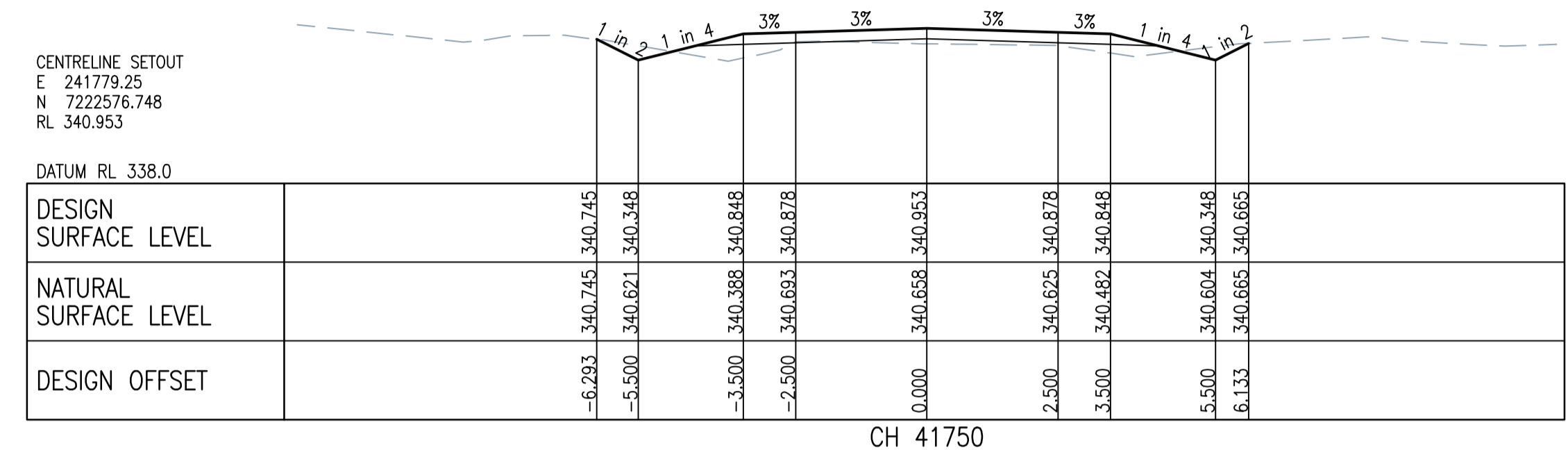
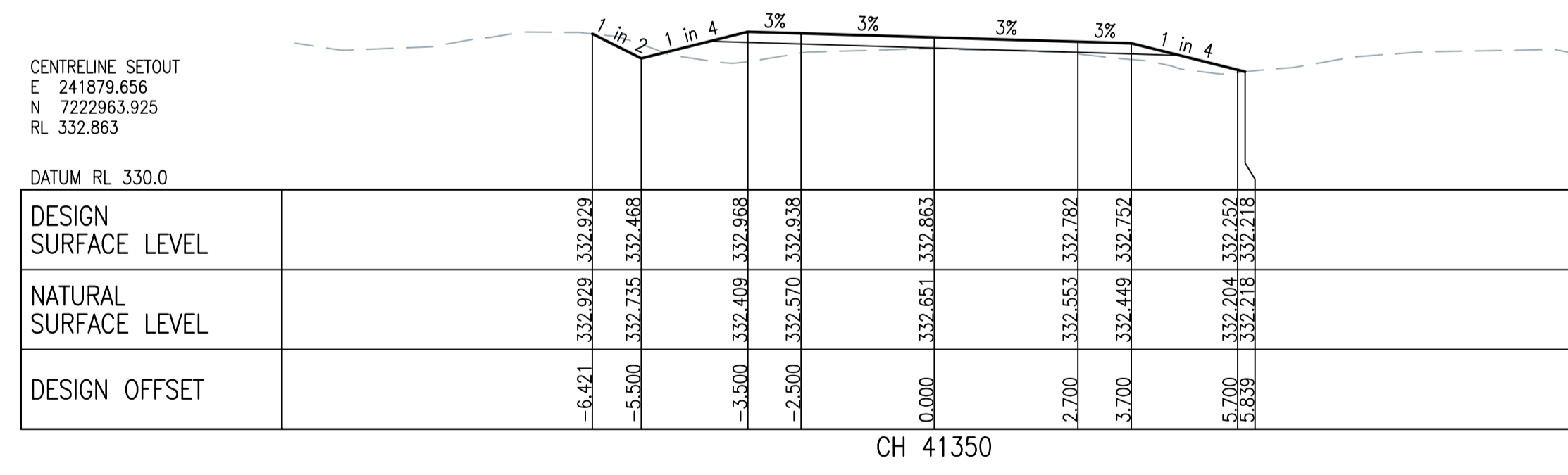
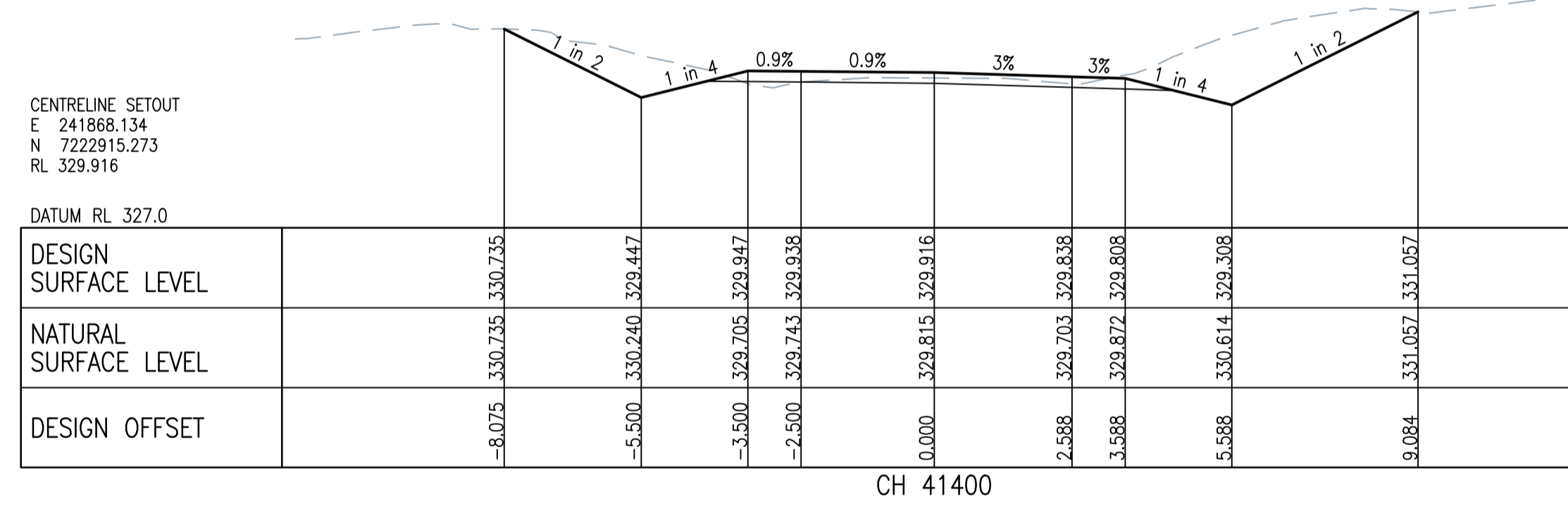
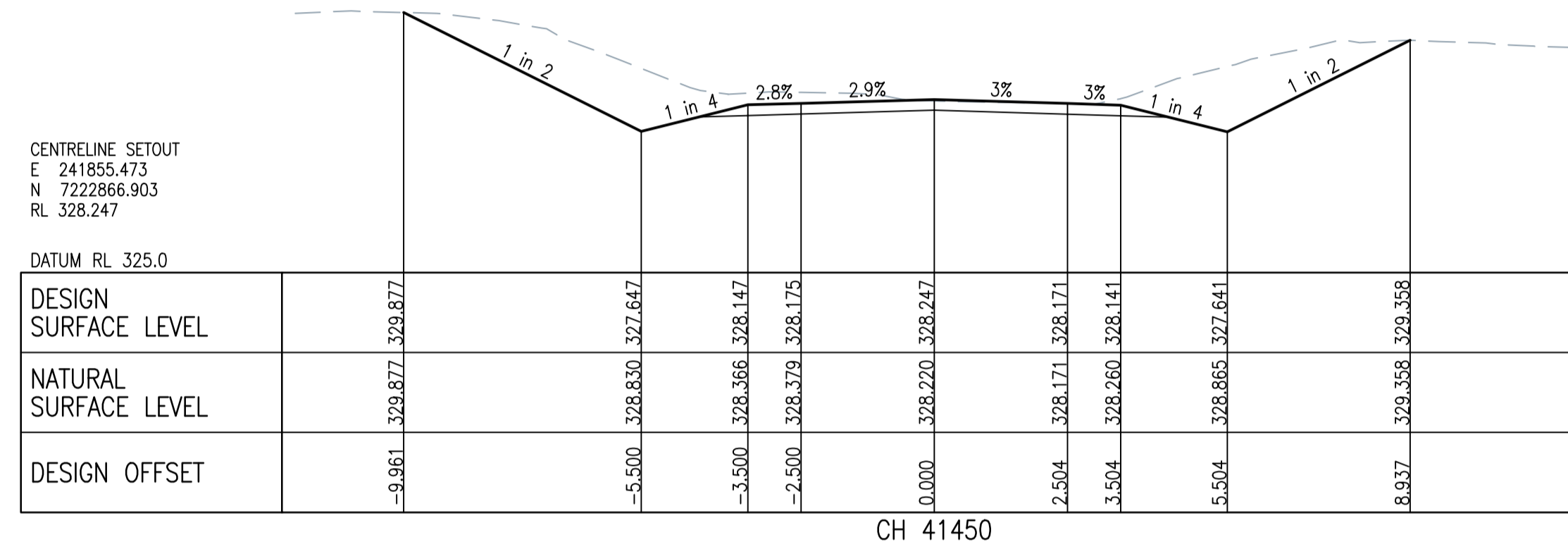
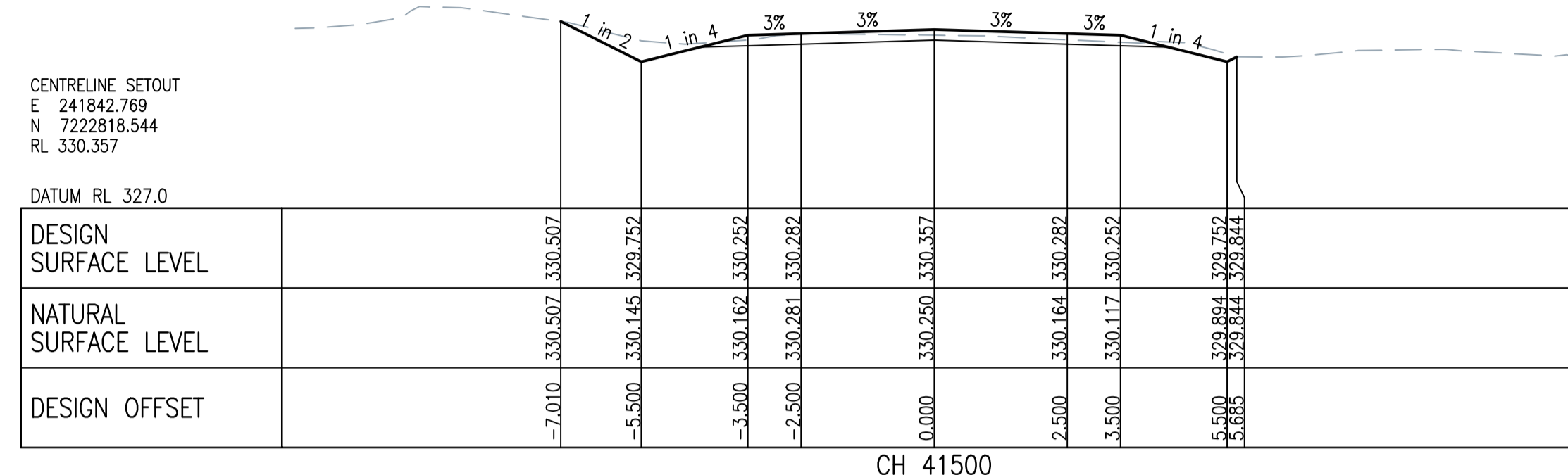

No.	Description	Reviewed	Approved	Date
1	TENDER ISSUE			23/08/2024



Client: BANANA SHIRE COUNCIL
Project: DEFENCE ROAD UPGRADE - CH 36,172 - CH68,499
Title: ANNOTATED CROSS SECTIONS SHEET 11 OF 64
Drawing No.: ARO0400-C60

Drawn: MS	Designed: MS	Approved: RPEQ	Date:
Drawing Check	Design Check		

Scale (A1 size): 1:100
Drawing is not to be used for construction unless approved.



51 Sheridan Street
Cairns Qld 4870
T (07) 4281 6897
E admin@arindustries.com.au
W www.arindustries.com.au
ABN: 49 641 461 298

CENTRELINE SETOUT
E 241715.73
N 7222334.952
RL 350.238

DATUM RL 347.0

DESIGN SURFACE LEVEL											
NATURAL SURFACE LEVEL											
DESIGN OFFSET											

CH 42000

CENTRELINE SETOUT
E 241728.434
N 7222383.311
RL 349.214

DATUM RL 346.0

DESIGN SURFACE LEVEL											
NATURAL SURFACE LEVEL											
DESIGN OFFSET											

CH 41950

CENTRELINE SETOUT
E 241741.138
N 7222431.67
RL 347.746

DATUM RL 345.0

DESIGN SURFACE LEVEL											
NATURAL SURFACE LEVEL											
DESIGN OFFSET											

CH 41900

CENTRELINE SETOUT
E 241766.546
N 7222528.389
RL 345.294

DATUM RL 340.0

DESIGN SURFACE LEVEL											
NATURAL SURFACE LEVEL											
DESIGN OFFSET											

CH 41800

CENTRELINE SETOUT
E 241640.3
N 7222044.59
RL 353.102

DATUM RL 350.0

DESIGN SURFACE LEVEL											
NATURAL SURFACE LEVEL											
DESIGN OFFSET											

CH 42300

CENTRELINE SETOUT
E 241665.647
N 7222141.324
RL 352.799

DATUM RL 349.0

DESIGN SURFACE LEVEL											
NATURAL SURFACE LEVEL											
DESIGN OFFSET											

CH 42200

CENTRELINE SETOUT
E 241690.662
N 7222238.145
RL 352.069

DATUM RL 349.0

DESIGN SURFACE LEVEL											
NATURAL SURFACE LEVEL											
DESIGN OFFSET											

CH 42100

CENTRELINE SETOUT
E 241703.169
N 7222286.555
RL 351.251

DATUM RL 348.0

DESIGN SURFACE LEVEL											
NATURAL SURFACE LEVEL											
DESIGN OFFSET											

CH 42050

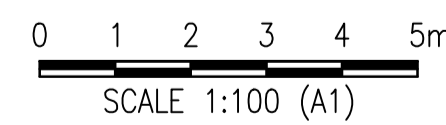

TENDER ISSUE ONLY

No.	Description	Reviewed	Approved	Date
1	TENDER ISSUE			23/08/2024



Client	BANANA SHIRE COUNCIL
Project	DEFENCE ROAD UPGRADE - CH 36,172 - CH68,499
Title	ANNOTATED CROSS SECTIONS SHEET 12 OF 64

Drawn	MS	Designed	MS	Approved	
Drawing Check		Design Check		RPEQ	Date

Scale (A1 size)	1:100
Drawing is not to be used for construction unless approved.	

51 Sheridan Street
Cairns Qld 4870
T (07) 4281 6897
E admin@arindustries.com.au
W www.arindustries.com.au
ABN: 49 641 461 298

CENTRELINE SETOUT
E 241589.493
N 7221851.151
RL 346.061

DATUM RL 343.0

DESIGN SURFACE LEVEL										
NATURAL SURFACE LEVEL										
DESIGN OFFSET										

CH 42500

CENTRELINE SETOUT
E 241602.195
N 7221899.511
RL 346.121

DATUM RL 345.0

DESIGN SURFACE LEVEL										
NATURAL SURFACE LEVEL										
DESIGN OFFSET										

CH 42450

CENTRELINE SETOUT
E 241614.897
N 7221947.871
RL 350.134

DATUM RL 347.0

DESIGN SURFACE LEVEL										
NATURAL SURFACE LEVEL										
DESIGN OFFSET										

CH 42400

CENTRELINE SETOUT
E 241627.598
N 7221996.23
RL 352.056

DATUM RL 349.0

DESIGN SURFACE LEVEL										
NATURAL SURFACE LEVEL										
DESIGN OFFSET										

CH 42350

CENTRELINE SETOUT
E 241525.999
N 7221609.349
RL 343.357

DATUM RL 340.0

DESIGN SURFACE LEVEL										
NATURAL SURFACE LEVEL										
DESIGN OFFSET										

CH 42750

CENTRELINE SETOUT
E 241538.697
N 7221657.709
RL 343.719

DATUM RL 340.0

DESIGN SURFACE LEVEL										
NATURAL SURFACE LEVEL										
DESIGN OFFSET										

CH 42700

CENTRELINE SETOUT
E 241564.093
N 7221754.431
RL 343.332

DATUM RL 340.0

DESIGN SURFACE LEVEL										
NATURAL SURFACE LEVEL										
DESIGN OFFSET										

CH 42600

CENTRELINE SETOUT
E 241576.792
N 7221802.791
RL 344.158

DATUM RL 341.0

DESIGN SURFACE LEVEL										
NATURAL SURFACE LEVEL										
DESIGN OFFSET										

CH 42550

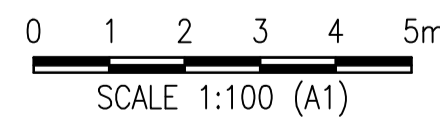

No.	Description	Reviewed	Approved	Date
1	TENDER ISSUE	-	-	23/08/2024



Client: BANANA SHIRE COUNCIL
Project: DEFENCE ROAD UPGRADE - CH 36,172 - CH68,499
Title: ANNOTATED CROSS SECTIONS SHEET 13 OF 64

Drawn	MS	Designed	MS	Approved	RPEQ	Date
Drawing Check		Design Check				

Scale (A1 size): 1:100

Drawing is not to be used for construction unless approved.

51 Sheridan Street
Cairns Qld 4870
T (07) 4281 6897
E admin@arindustries.com.au
W www.arindustries.com.au
ABN: 49 641 461 298

TENDER ISSUE ONLY

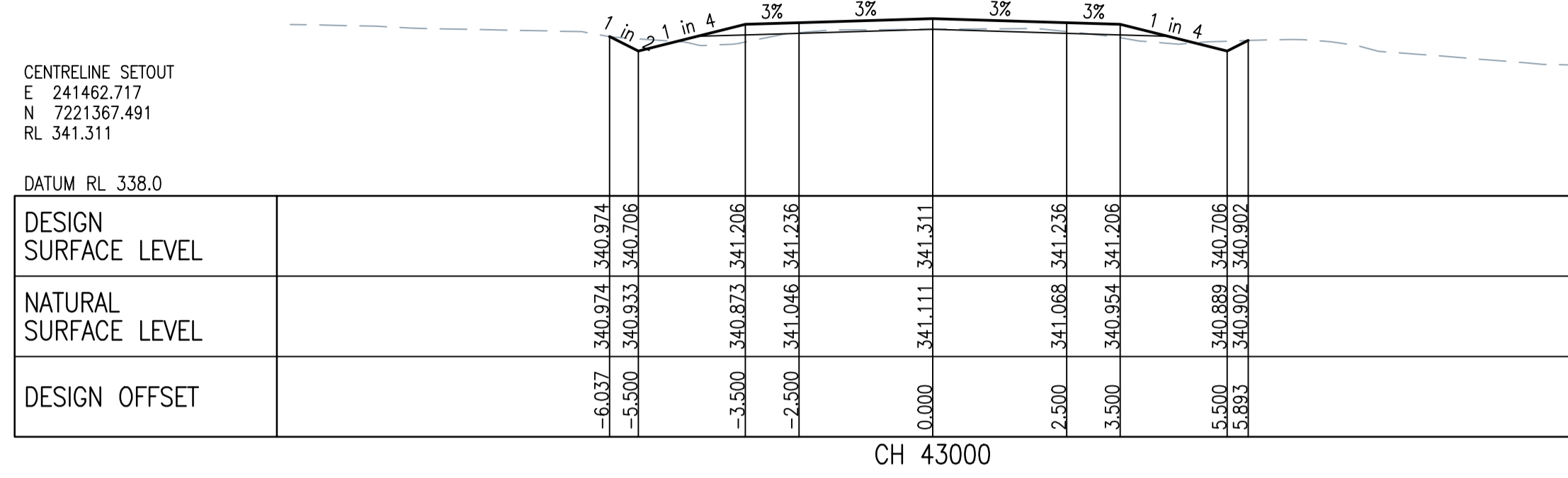

CH 43000

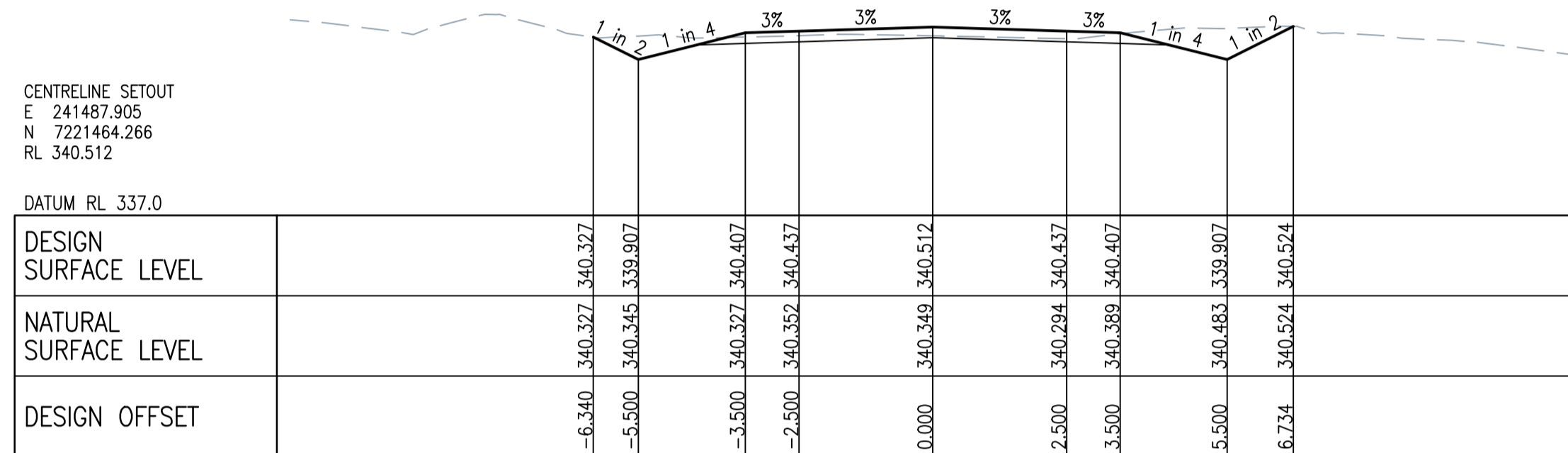

CH 42900

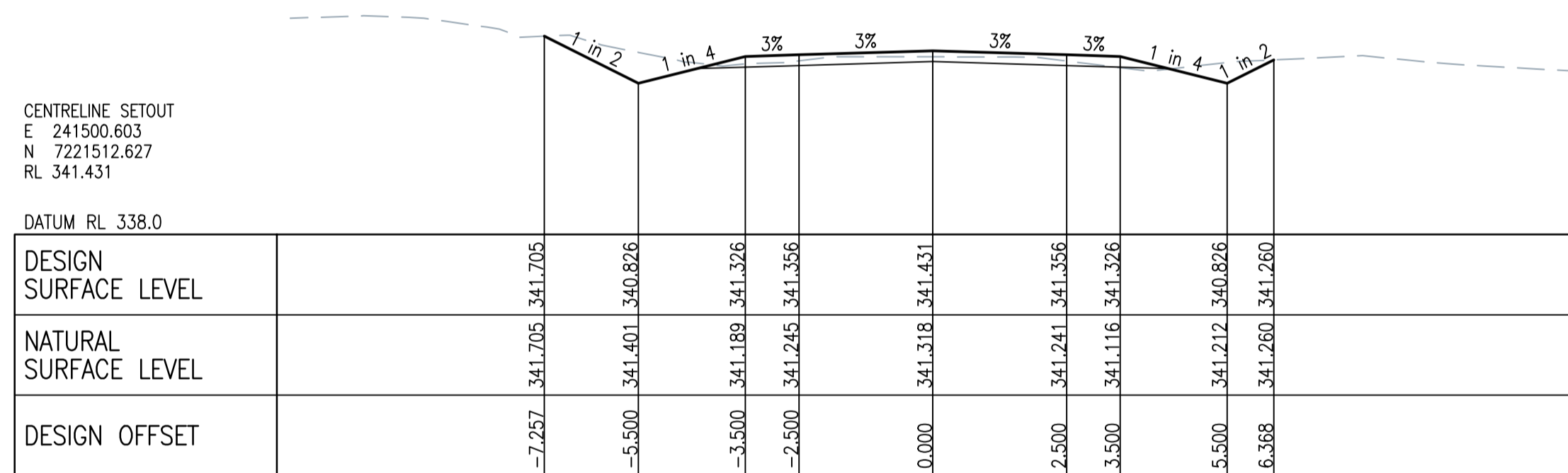

CH 42850

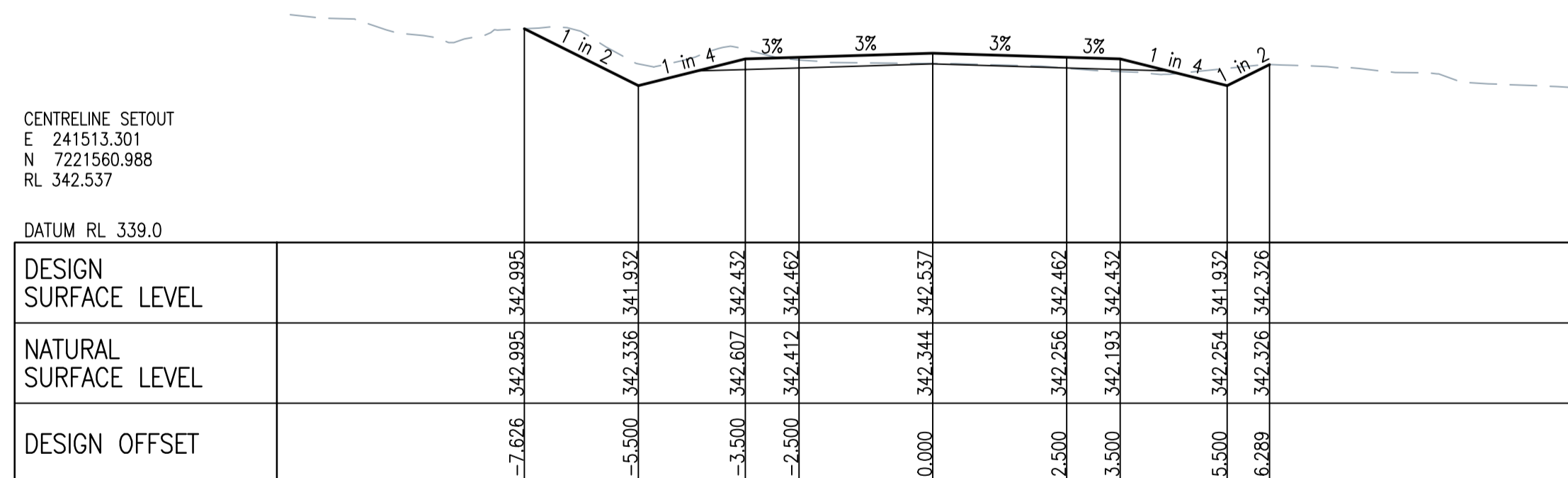

CH 42800

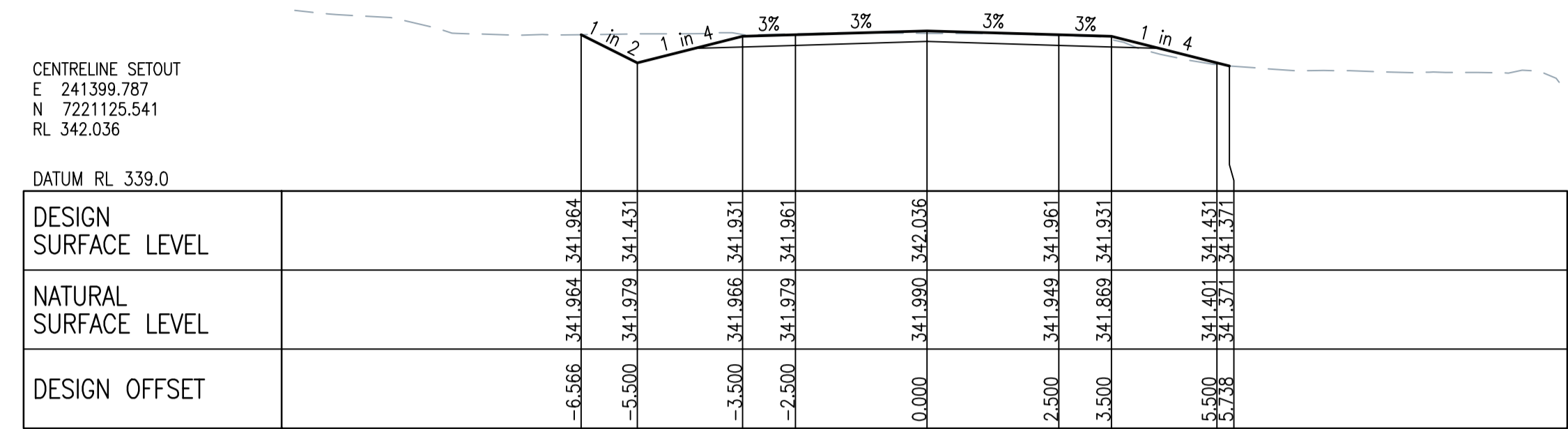

CH 43250

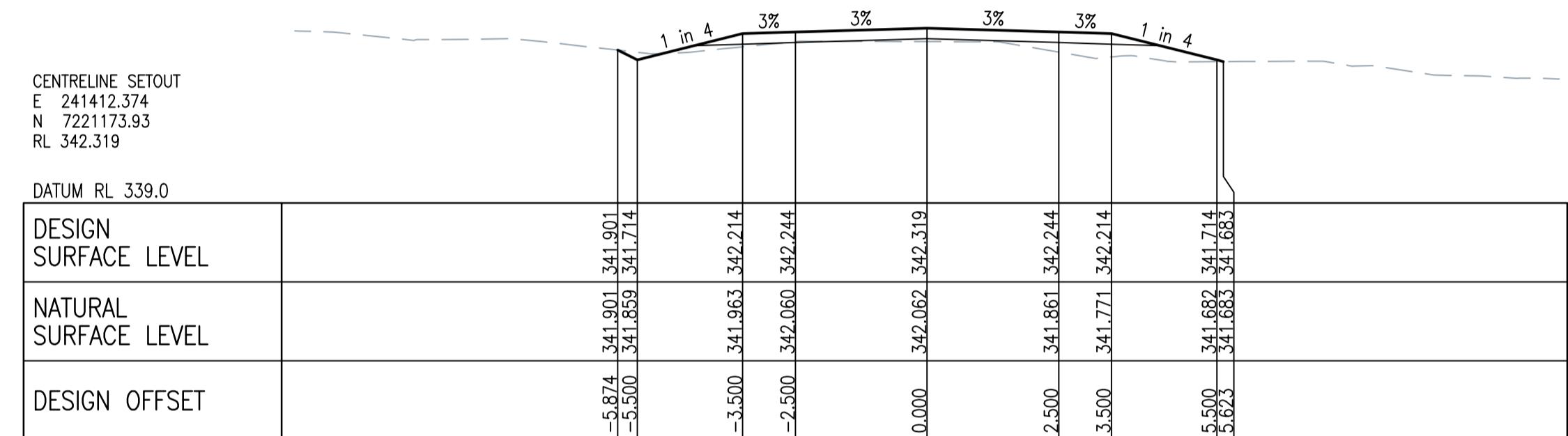

CH 43200

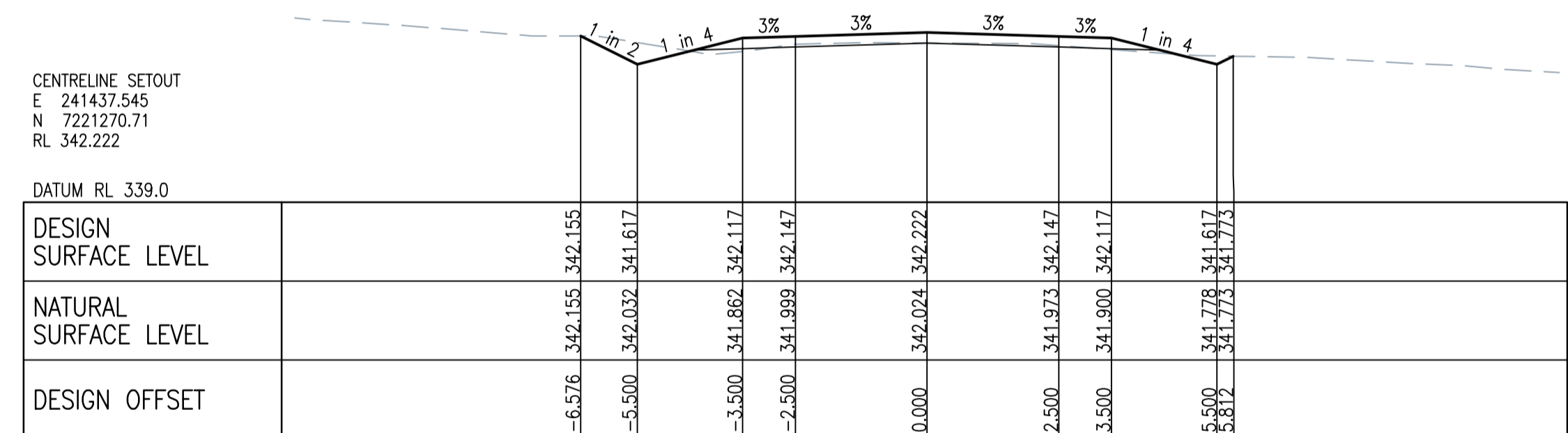

CH 43100

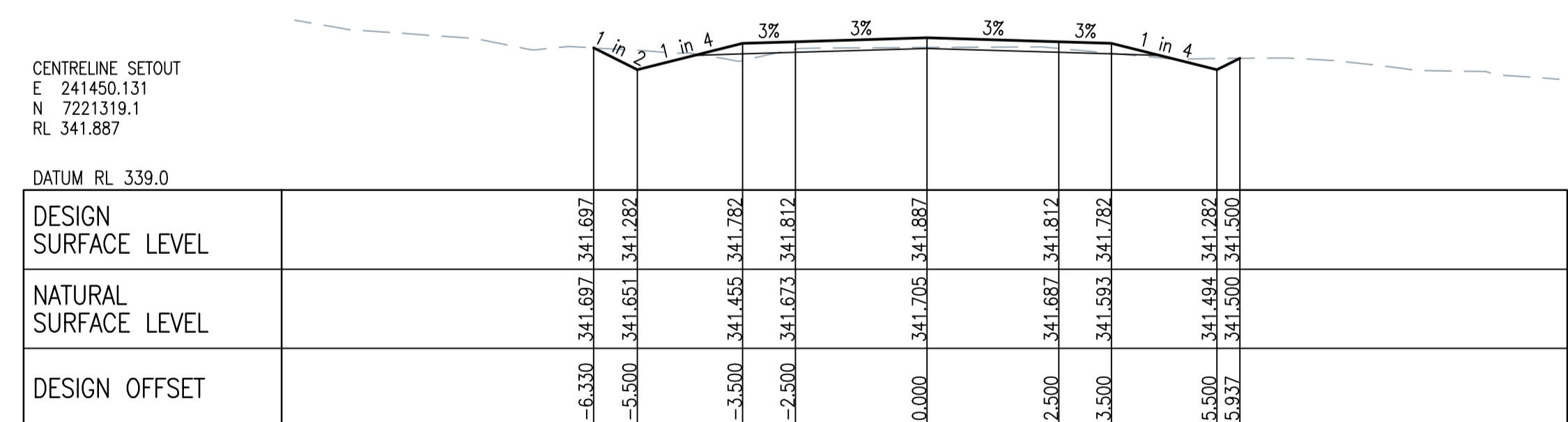

CH 43050

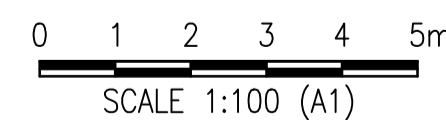

No.	Description	Reviewed	Approved	Date
1	TENDER ISSUE			23/08/2024



Client	BANANA SHIRE COUNCIL
Project	DEFENCE ROAD UPGRADE - CH 36,172 - CH68,499
Title	ANNOTATED CROSS SECTIONS SHEET 14 OF 64

Drawn	MS	Designed	MS	Approved		Scale (A1 size)	1:100
Drawing Check		Design Check		RPEQ	Date	Drawing is not to be used for construction unless approved.	



51 Sheridan Street
Cairns Qld 4870
T (07) 4281 6897
E admin@aroindustries.com.au
W www.aroindustries.com.au
ABN: 49 641 461 298

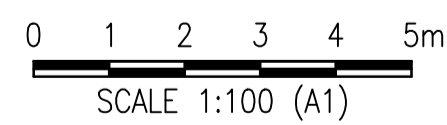
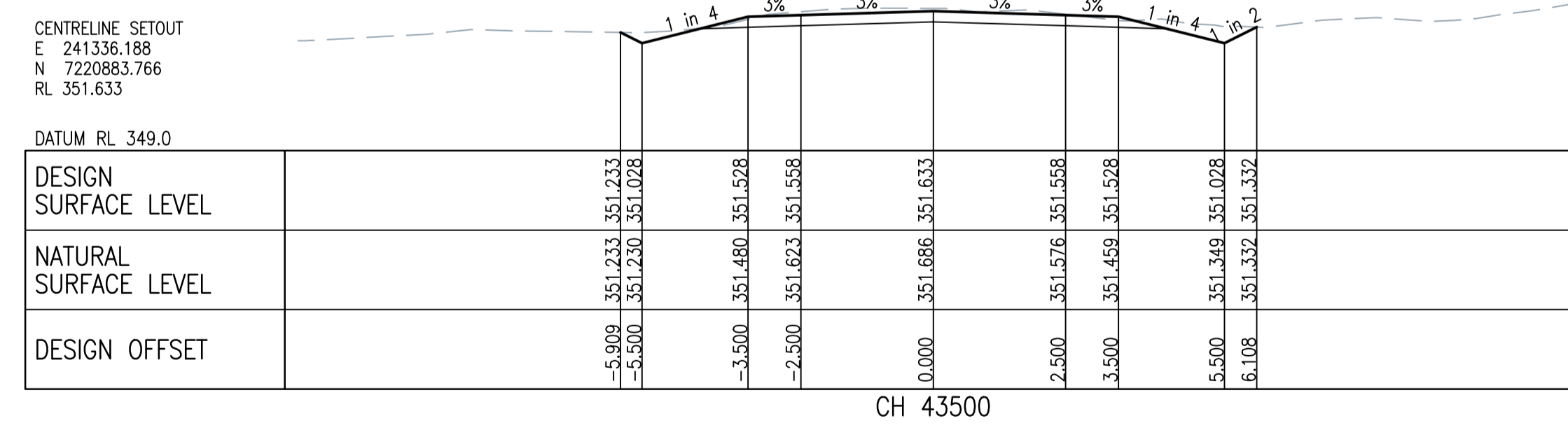
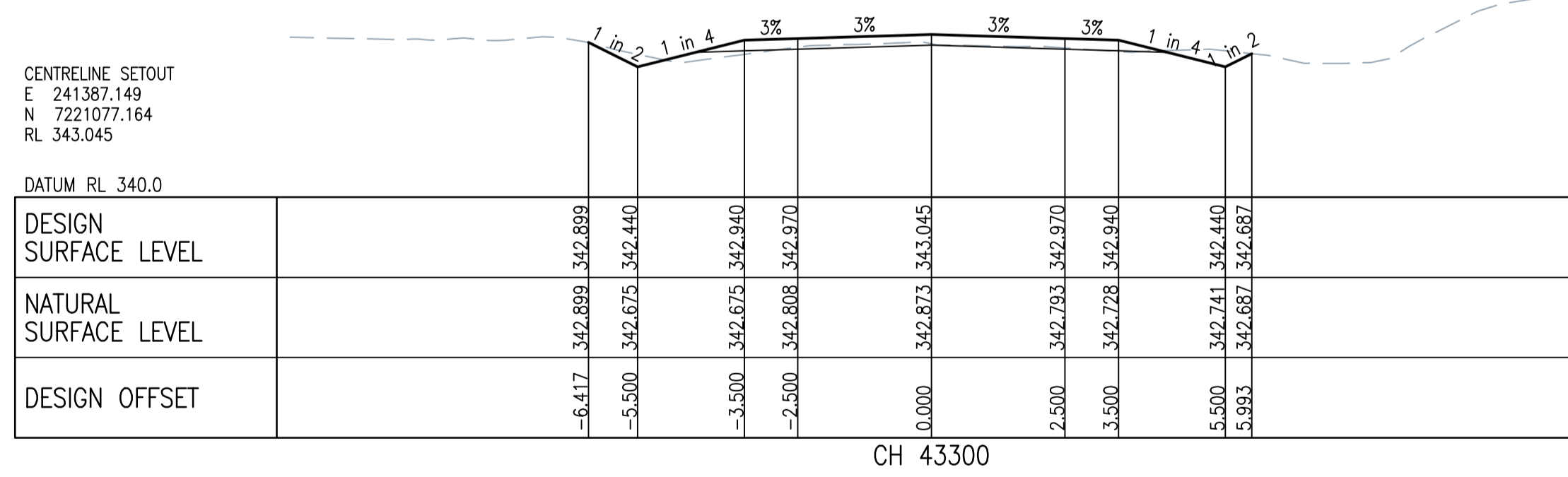
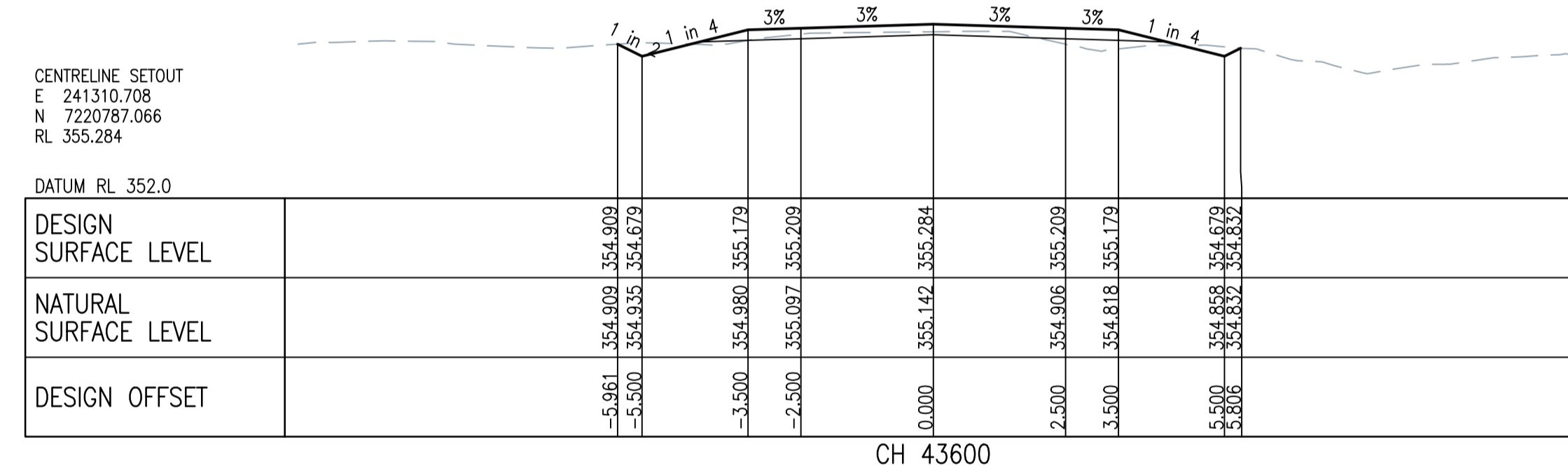
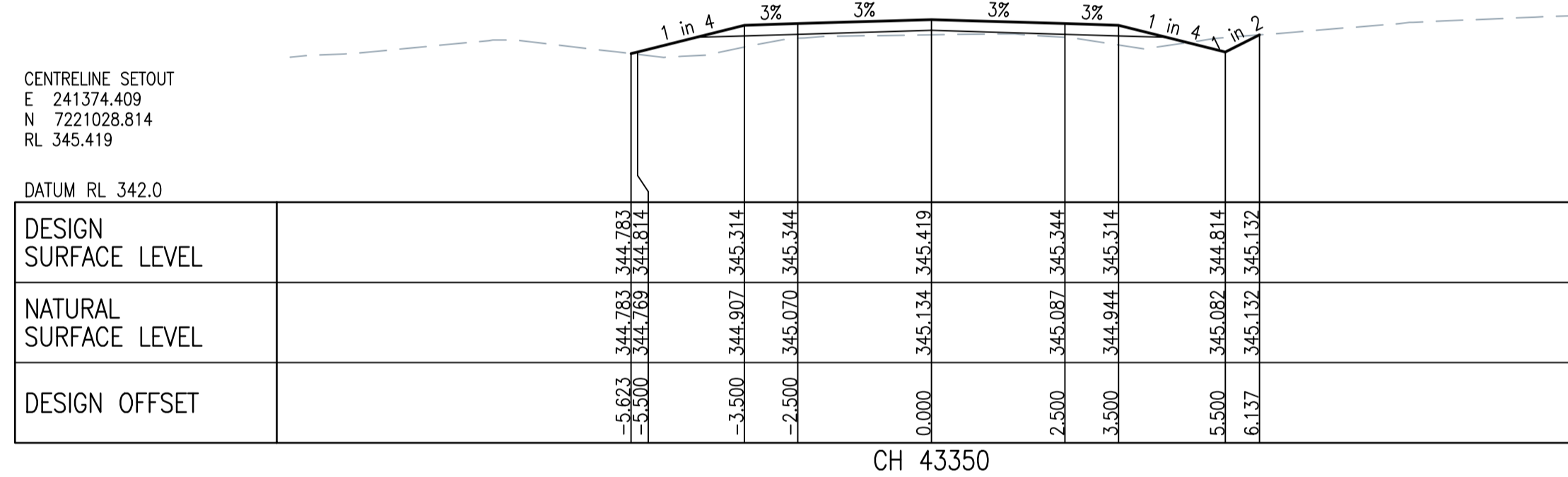
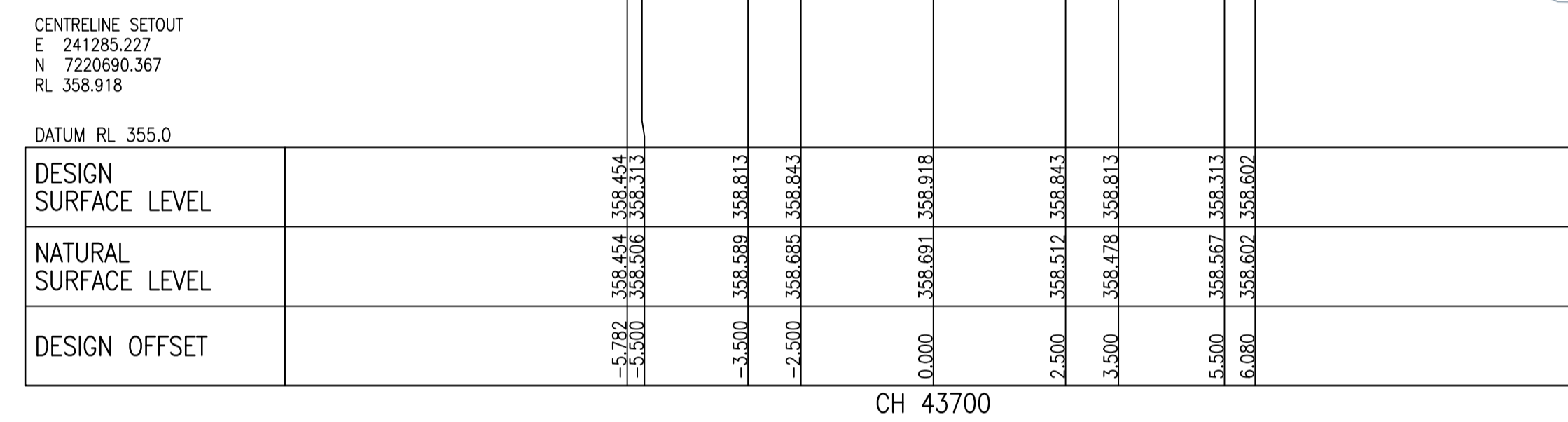
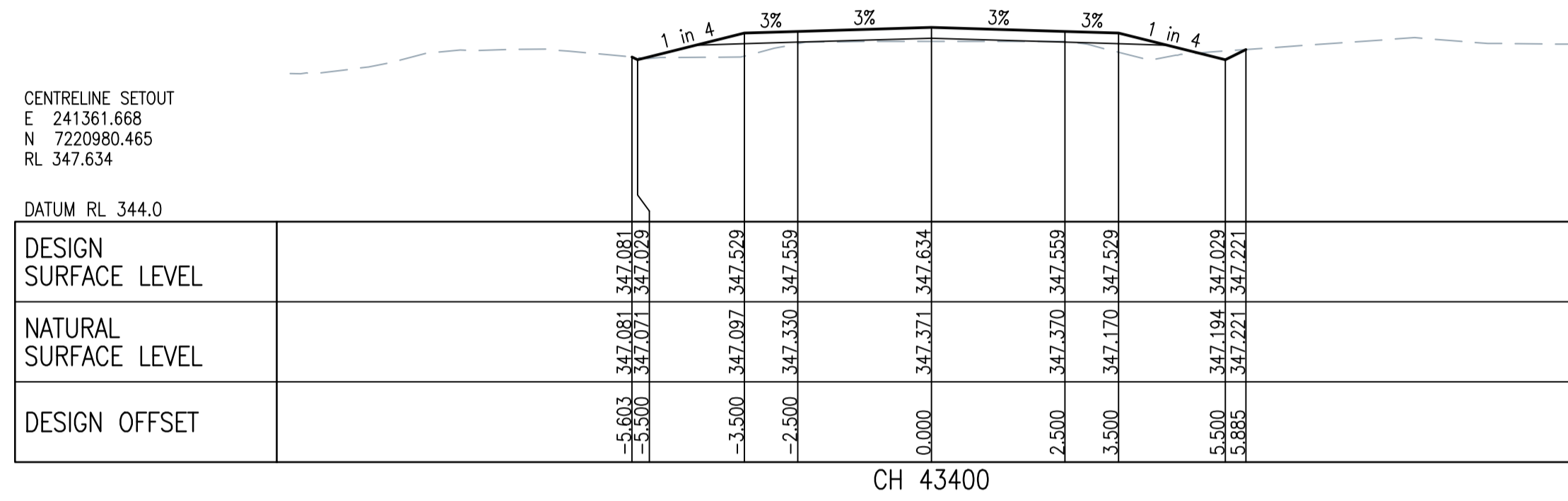
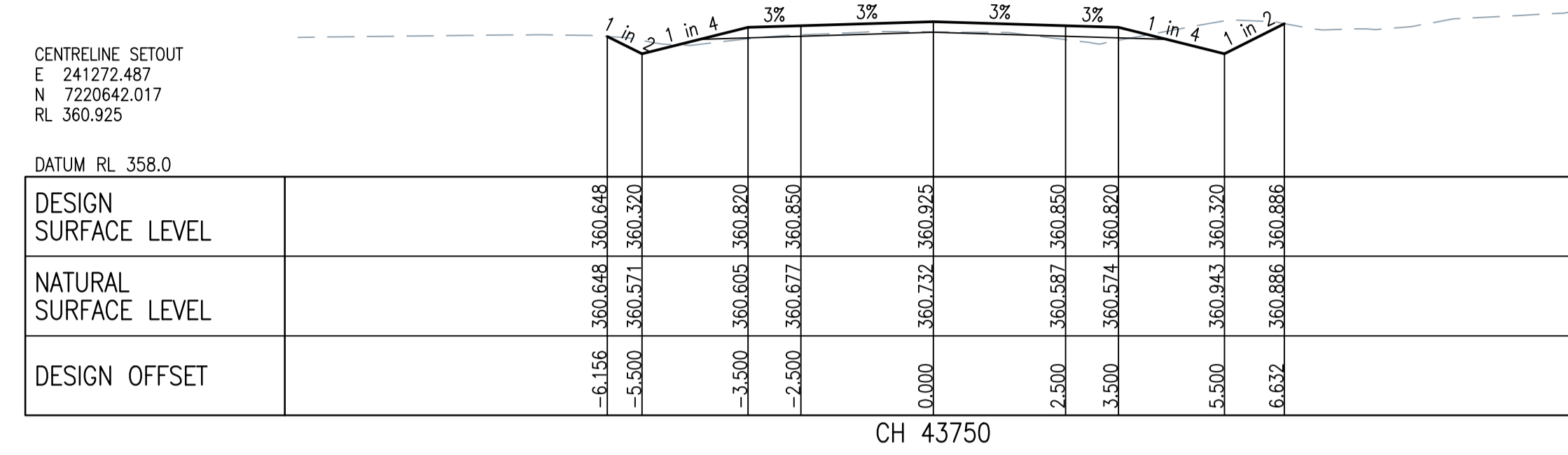
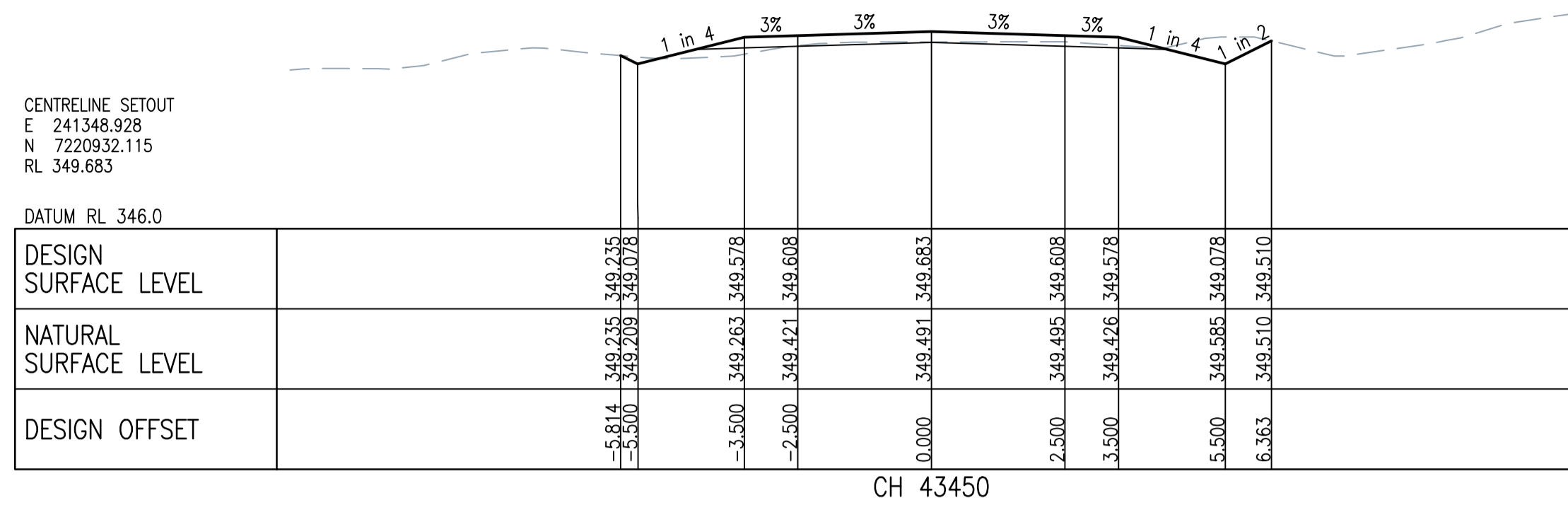

TENDER ISSUE ONLY

No.	Description	Reviewed	Approved	Date
1	TENDER ISSUE			23/08/2024



Client: BANANA SHIRE COUNCIL
Project: DEFENCE ROAD UPGRADE - CH 36,172 - CH68,499
Title: ANNOTATED CROSS SECTIONS SHEET 15 OF 64

Drawn	Designed	Approved	Scale (A1 size)
MS	MS		1:100
Drawing Check	Design Check	RPEQ	Date



51 Sheridan Street
Cairns Qld 4870
T (07) 4281 6897
E admin@arindustries.com.au
W www.arindustries.com.au
ABN: 69 641 461 298

CENTRELINE SETOUT
E 241211.705
N 7220399.603
RL 371.884

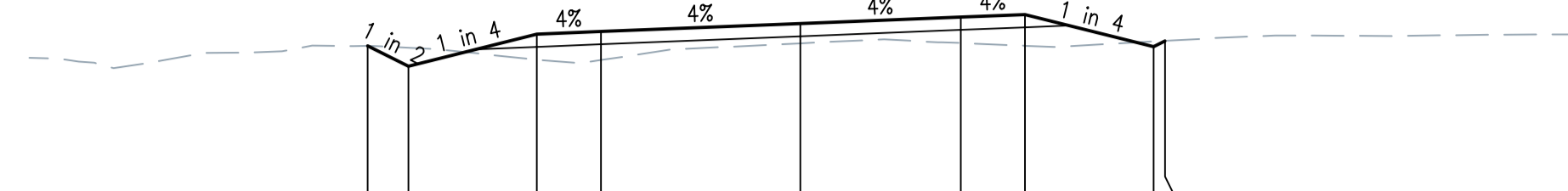

DATUM RL 369.0	
DESIGN SURFACE LEVEL	-6.732 371.536 371.536 -6.100 371.506 371.220 -4.100 371.320 371.720 -3.100 371.315 371.760 0.000 371.576 371.884 2.500 371.579 371.984 3.500 371.537 372.024 5.500 371.604 371.924 5.680 371.613 371.613
NATURAL SURFACE LEVEL	
DESIGN OFFSET	

CH 44000

CENTRELINE SETOUT
E 241202.589
N 7220100.498
RL 364.495

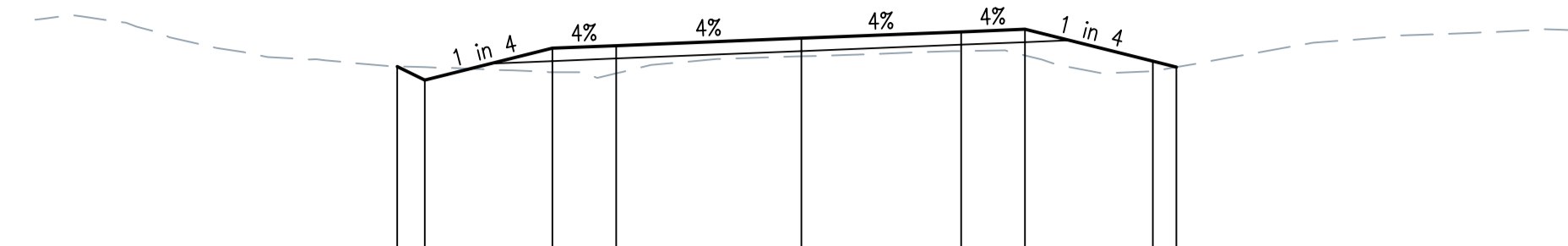

DATUM RL 361.0	
DESIGN SURFACE LEVEL	-6.330 364.053 364.053 -5.900 364.041 363.839 -3.900 363.964 364.339 -2.900 363.945 364.379 0.000 364.212 364.495 2.500 364.294 364.595 3.500 364.224 364.635 5.500 363.977 364.135 5.869 364.042 364.042
NATURAL SURFACE LEVEL	
DESIGN OFFSET	

CH 44300

CENTRELINE SETOUT
E 241221.606
N 7220448.598
RL 370.245

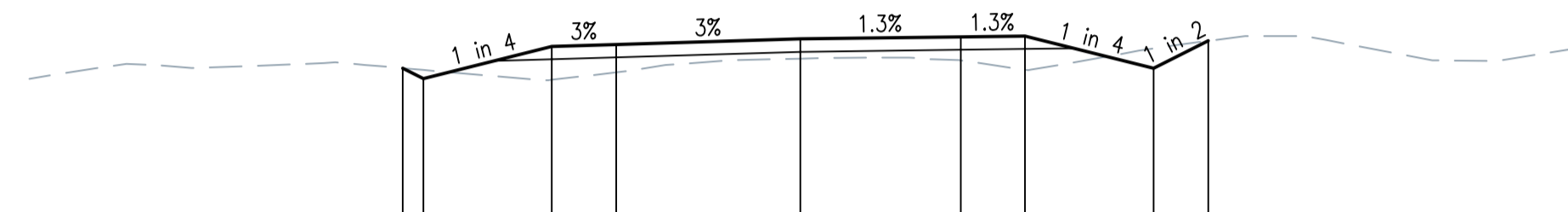

DATUM RL 367.0	
DESIGN SURFACE LEVEL	-6.189 369.790 369.790 -5.866 369.763 369.679 -3.866 369.609 370.129 -2.866 369.725 370.159 0.000 369.938 370.245 2.500 369.912 370.277 3.500 369.765 370.290 5.500 370.096 369.790 6.349 370.215 370.215
NATURAL SURFACE LEVEL	
DESIGN OFFSET	

CH 43950

CENTRELINE SETOUT
E 241197.263
N 7220200.325
RL 371.721

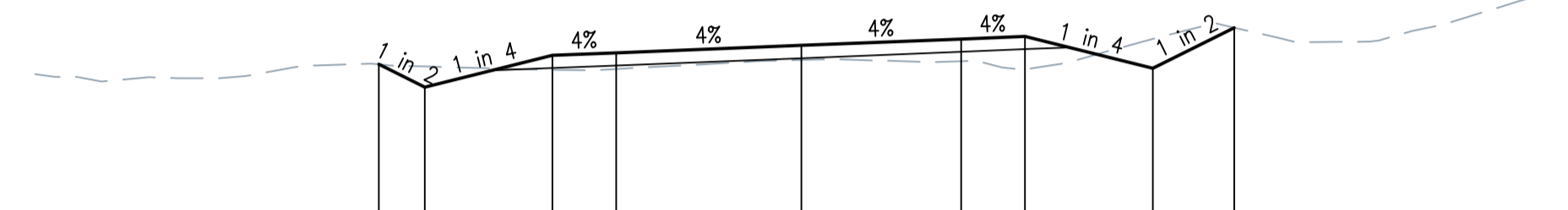

DATUM RL 369.0	
DESIGN SURFACE LEVEL	-6.618 371.424 371.424 -5.900 371.391 371.085 -3.900 371.336 371.565 -2.900 371.351 371.605 0.000 371.492 371.721 2.500 371.475 371.821 3.500 371.346 371.861 5.500 371.823 371.361 6.777 372.000 372.000
NATURAL SURFACE LEVEL	
DESIGN OFFSET	

CH 44200

CENTRELINE SETOUT
E 241234.266
N 7220496.968
RL 368.15

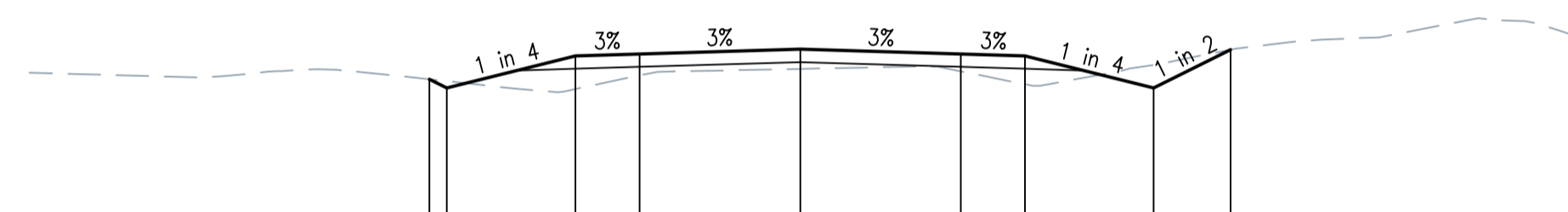

DATUM RL 365.0	
DESIGN SURFACE LEVEL	-5.772 367.681 367.681 -5.500 367.651 367.545 -3.500 367.528 368.045 -2.500 367.741 368.075 0.000 367.844 368.150 2.500 367.805 368.075 3.500 367.603 368.045 5.500 367.903 367.545 6.699 368.144 368.144
NATURAL SURFACE LEVEL	
DESIGN OFFSET	

CH 43900

CENTRELINE SETOUT
E 241197.858
N 7220250.317
RL 373.699

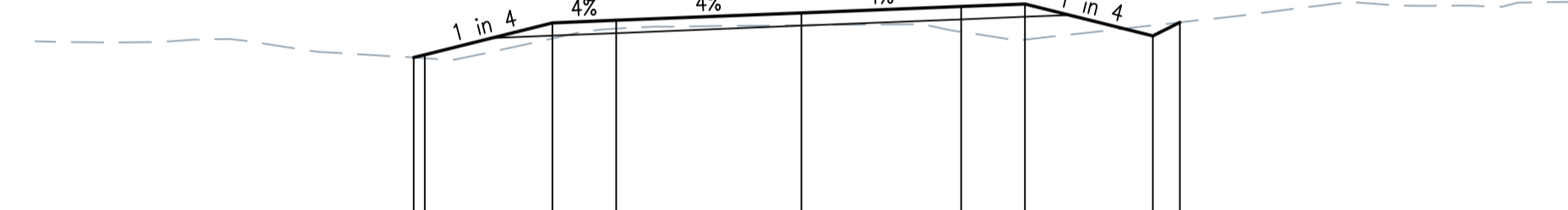

DATUM RL 370.0	
DESIGN SURFACE LEVEL	-6.072 373.000 373.000 -5.900 372.988 372.843 -3.900 372.928 373.543 -2.900 372.454 373.583 0.000 373.506 373.699 2.500 373.402 373.799 3.500 373.280 373.839 5.500 373.504 373.339 5.924 373.551 373.551
NATURAL SURFACE LEVEL	
DESIGN OFFSET	

CH 44150

CENTRELINE SETOUT
E 241259.747
N 7220593.668
RL 363.252

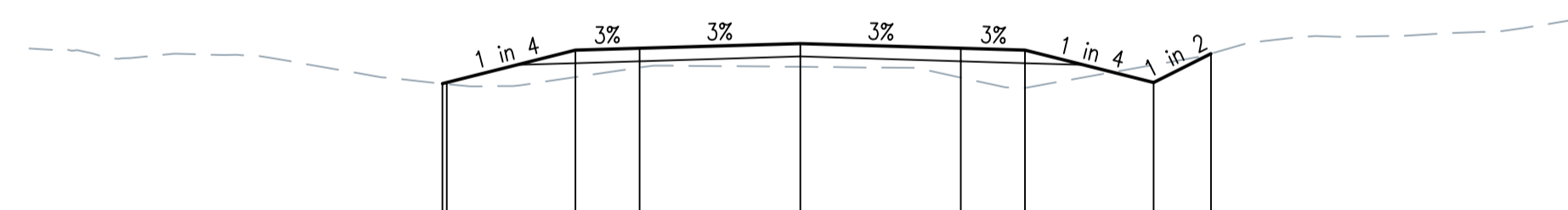

DATUM RL 360.0	
DESIGN SURFACE LEVEL	-5.571 362.630 362.630 -5.500 362.622 362.627 -3.500 362.729 363.147 -2.500 362.878 363.177 0.000 362.889 363.252 2.500 362.722 363.177 3.500 362.562 363.147 5.500 362.919 362.647 6.395 363.095 363.095
NATURAL SURFACE LEVEL	
DESIGN OFFSET	

CH 43800

CENTRELINE SETOUT
E 241200.626
N 7220300.236
RL 374.054

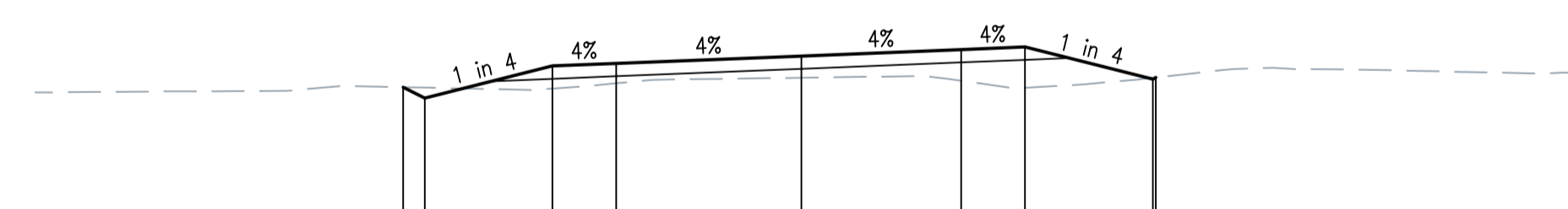

DATUM RL 371.0	
DESIGN SURFACE LEVEL	-6.236 373.566 373.566 -5.900 373.559 373.388 -3.900 373.544 373.898 -2.900 373.627 373.938 0.000 373.714 374.054 2.500 373.667 374.154 3.500 373.557 374.194 5.500 373.712 373.684 5.548 373.718 373.718
NATURAL SURFACE LEVEL	
DESIGN OFFSET	

CH 44100

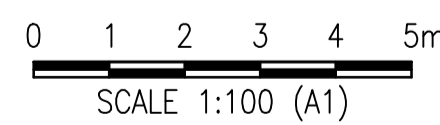

No.	Description	Reviewed	Approved	Date
1	TENDER ISSUE			23/08/2024



Client	BANANA SHIRE COUNCIL
Project	DEFENCE ROAD UPGRADE - CH 36,172 - CH68,499
Title	ANNOTATED CROSS SECTIONS SHEET 16 OF 64

Drawn	MS	Designed	MS	Approved	
Drawing Check		Design Check		RPEQ	Date

Scale (A1 size)
1:100

Drawing is not to be used for construction unless approved.

51 Sheridan Street
Cairns Qld 4870
T (07) 4281 6897
E admin@arindustries.com.au
W www.arindustries.com.au
ABN: 49 641 461 298

CENTRELINE SETOUT
E 241292.87
N 7219406.369
RL 336.697

DATUM RL 334.0	
DESIGN SURFACE LEVEL	
NATURAL SURFACE LEVEL	
DESIGN OFFSET	

CH 45000

CENTRELINE SETOUT
E 241286.053
N 7219455.902
RL 339.313

DATUM RL 336.0	
DESIGN SURFACE LEVEL	
NATURAL SURFACE LEVEL	
DESIGN OFFSET	

CH 44950

CENTRELINE SETOUT
E 241279.237
N 7219505.435
RL 342.034

DATUM RL 339.0	
DESIGN SURFACE LEVEL	
NATURAL SURFACE LEVEL	
DESIGN OFFSET	

CH 44900

CENTRELINE SETOUT
E 241265.89
N 7219604.539
RL 347.501

DATUM RL 344.0	
DESIGN SURFACE LEVEL	
NATURAL SURFACE LEVEL	
DESIGN OFFSET	

CH 44800

CENTRELINE SETOUT
E 241332.754
N 7219109.033
RL 336.157

DATUM RL 333.0	
DESIGN SURFACE LEVEL	
NATURAL SURFACE LEVEL	
DESIGN OFFSET	

CH 45300

CENTRELINE SETOUT
E 241326.239
N 7219158.607
RL 334.67

DATUM RL 331.0	
DESIGN SURFACE LEVEL	
NATURAL SURFACE LEVEL	
DESIGN OFFSET	

CH 45250

CENTRELINE SETOUT
E 241319.724
N 7219208.181
RL 333.014

DATUM RL 330.0	
DESIGN SURFACE LEVEL	
NATURAL SURFACE LEVEL	
DESIGN OFFSET	

CH 45200

CENTRELINE SETOUT
E 241306.503
N 7219307.302
RL 331.685

DATUM RL 329.0	
DESIGN SURFACE LEVEL	
NATURAL SURFACE LEVEL	
DESIGN OFFSET	

CH 45100

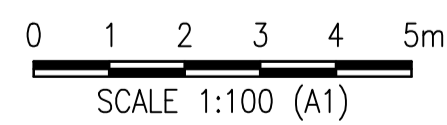

No.	Description	Reviewed	Approved	Date
1	TENDER ISSUE			23/08/2024



Client	BANANA SHIRE COUNCIL
Project	DEFENCE ROAD UPGRADE - CH 36,172 - CH68,499
Title	ANNOTATED CROSS SECTIONS SHEET 18 OF 64

Drawn	MS
Designed	MS
Approved	
Drawing Check	
Design Check	
RPEQ	
Date	

Scale (A1 size)	1:100
Drawing is not to be used for construction unless approved.	

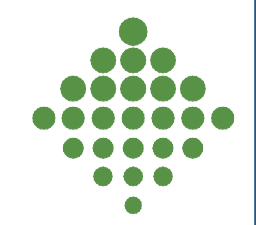

TENDER ISSUE ONLY

51 Sheridan Street
Cairns Qld 4870
T (07) 4281 6897
E admin@arindustries.com.au
W www.arindustries.com.au
ABN: 69 641 461 298

CENTRELINE SETOUT
E 241365.328
N 7218861.164
RL 349.396

DATUM RL 346.0

DESIGN SURFACE LEVEL									
NATURAL SURFACE LEVEL									
DESIGN OFFSET									

CH 45550

CENTRELINE SETOUT
E 241350.813
N 7218910.738
RL 346.899

DATUM RL 343.0

DESIGN SURFACE LEVEL									
NATURAL SURFACE LEVEL									
DESIGN OFFSET									

CH 45500

CENTRELINE SETOUT
E 241345.784
N 7219009.886
RL 341.035

DATUM RL 338.0

DESIGN SURFACE LEVEL									
NATURAL SURFACE LEVEL									
DESIGN OFFSET									

CH 45400

CENTRELINE SETOUT
E 241339.269
N 7219059.459
RL 338.246

DATUM RL 335.0

DESIGN SURFACE LEVEL									
NATURAL SURFACE LEVEL									
DESIGN OFFSET									

CH 45350

CENTRELINE SETOUT
E 241432.621
N 7218517.782
RL 354.348

DATUM RL 351.0

DESIGN SURFACE LEVEL									
NATURAL SURFACE LEVEL									
DESIGN OFFSET									

CH 45900

CENTRELINE SETOUT
E 241412.729
N 7218615.784
RL 353.333

DATUM RL 350.0

DESIGN SURFACE LEVEL									
NATURAL SURFACE LEVEL									
DESIGN OFFSET									

CH 45800

CENTRELINE SETOUT
E 241392.224
N 7218713.658
RL 352.317

DATUM RL 349.0

DESIGN SURFACE LEVEL									
NATURAL SURFACE LEVEL									
DESIGN OFFSET									

CH 45700

CENTRELINE SETOUT
E 241372.547
N 7218611.691
RL 351.027

DATUM RL 348.0

DESIGN SURFACE LEVEL									
NATURAL SURFACE LEVEL									
DESIGN OFFSET									

CH 45600

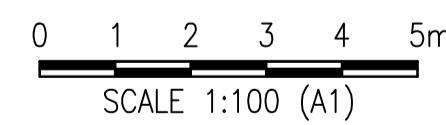

TENDER ISSUE ONLY

No.	Description	Reviewed	Approved	Date
1	TENDER ISSUE			23/08/2024



Client	BANANA SHIRE COUNCIL
Project	DEFENCE ROAD UPGRADE - CH 36,172 - CH68,499
Title	ANNOTATED CROSS SECTIONS SHEET 19 OF 64

Drawn	MS	Designed	MS	Approved		Scale (A1 size)	1:100
Drawing Check		Design Check		RPEQ	Date	Drawing is not to be used for construction unless approved.	



51 Sheridan Street
Cairns Qld 4870
T (07) 4281 6897
E admin@arindustries.com.au
W www.arindustries.com.au
ABN: 49 641 461 298

CENTRELINE SETOUT
E 241472.404
N 7218321.779
RL 355.436

DATUM RL 352.0

DESIGN SURFACE LEVEL	-6.898	355.530	355.530																	
NATURAL SURFACE LEVEL																				
DESIGN OFFSET																				

CH 46100

CENTRELINE SETOUT
E 241462.459
N 7218370.78
RL 355.366

DATUM RL 352.0

DESIGN SURFACE LEVEL	-6.998	355.510	355.510																	
NATURAL SURFACE LEVEL																				
DESIGN OFFSET																				

CH 46050

CENTRELINE SETOUT
E 241452.513
N 7218419.781
RL 355.196

DATUM RL 352.0

DESIGN SURFACE LEVEL	-6.676	355.179	355.179																	
NATURAL SURFACE LEVEL																				
DESIGN OFFSET																				

CH 46000

CENTRELINE SETOUT
E 241442.567
N 7218468.781
RL 354.844

DATUM RL 351.0

DESIGN SURFACE LEVEL	-6.521	354.750	354.750																	
NATURAL SURFACE LEVEL																				
DESIGN OFFSET																				

CH 45950

CENTRELINE SETOUT
E 241511.893
N 7218125.717
RL 353.478

DATUM RL 350.0

DESIGN SURFACE LEVEL	-6.835	353.540	353.540																	
NATURAL SURFACE LEVEL																				
DESIGN OFFSET																				

CH 46300

CENTRELINE SETOUT
E 241502.242
N 7218174.776
RL 354.424

DATUM RL 351.0

DESIGN SURFACE LEVEL	-6.933	354.536	354.536																	
NATURAL SURFACE LEVEL																				
DESIGN OFFSET																				

CH 46250

CENTRELINE SETOUT
E 241492.296
N 7218223.777
RL 354.994

DATUM RL 352.0

DESIGN SURFACE LEVEL	-7.156	355.217	355.217																	
NATURAL SURFACE LEVEL																				
DESIGN OFFSET																				

CH 46200

CENTRELINE SETOUT
E 241482.35
N 7218272.778
RL 355.373

DATUM RL 352.0

DESIGN SURFACE LEVEL	-7.524	355.780	355.780																	
NATURAL SURFACE LEVEL																				
DESIGN OFFSET																				

CH 46150

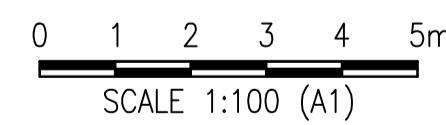

No.	Description	Reviewed	Approved	Date
1	TENDER ISSUE			23/08/2024



Client	BANANA SHIRE COUNCIL
Project	DEFENCE ROAD UPGRADE - CH 36,172 - CH68,499
Title	ANNOTATED CROSS SECTIONS SHEET 20 OF 64
Drawing No.	ARO0400-C69

Drawn	MS	Designed	MS	Approved		Scale (A1 size)	1:100
Drawing Check		Design Check		RPEQ	Date	Drawing is not to be used for construction unless approved.	
51 Sheridan Street Cairns Qld 4870 T (07) 4281 6897 E admin@aroindustries.com.au W www.aroindustries.com.au ABN: 49 641 461 298							

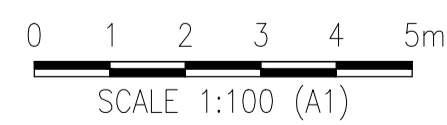
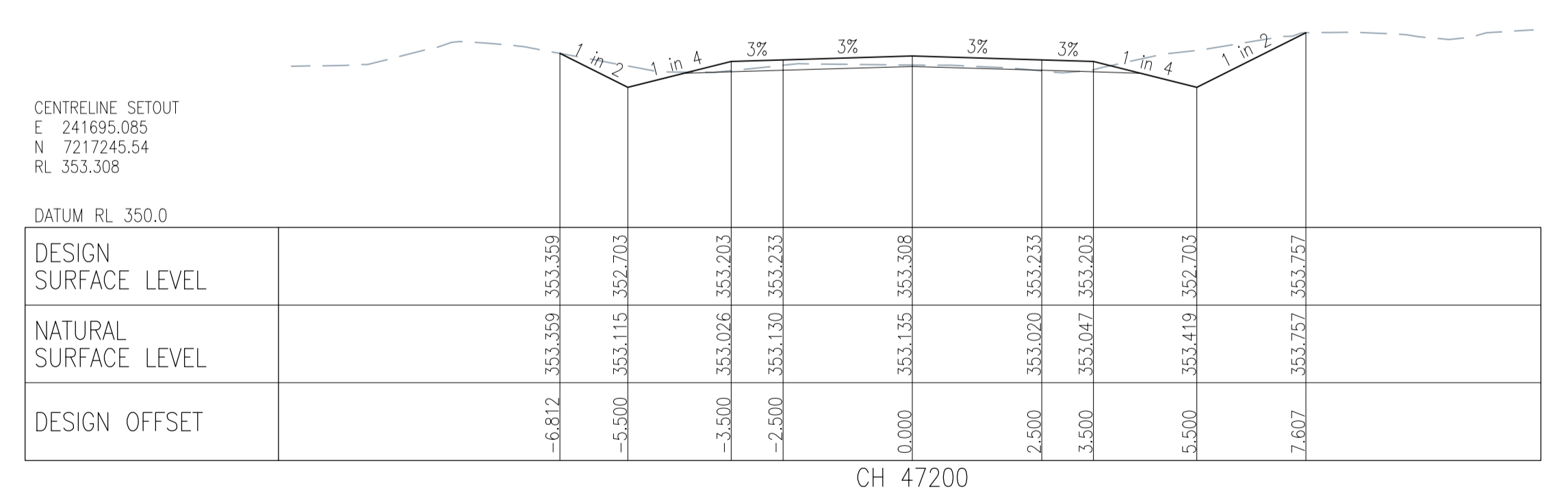
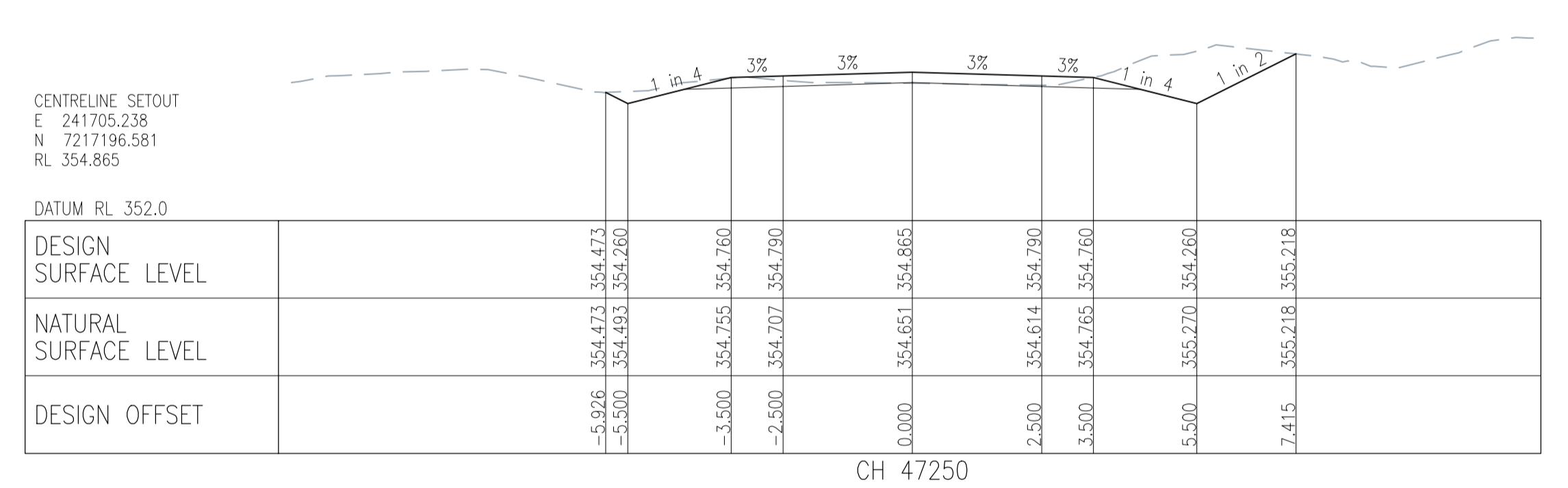
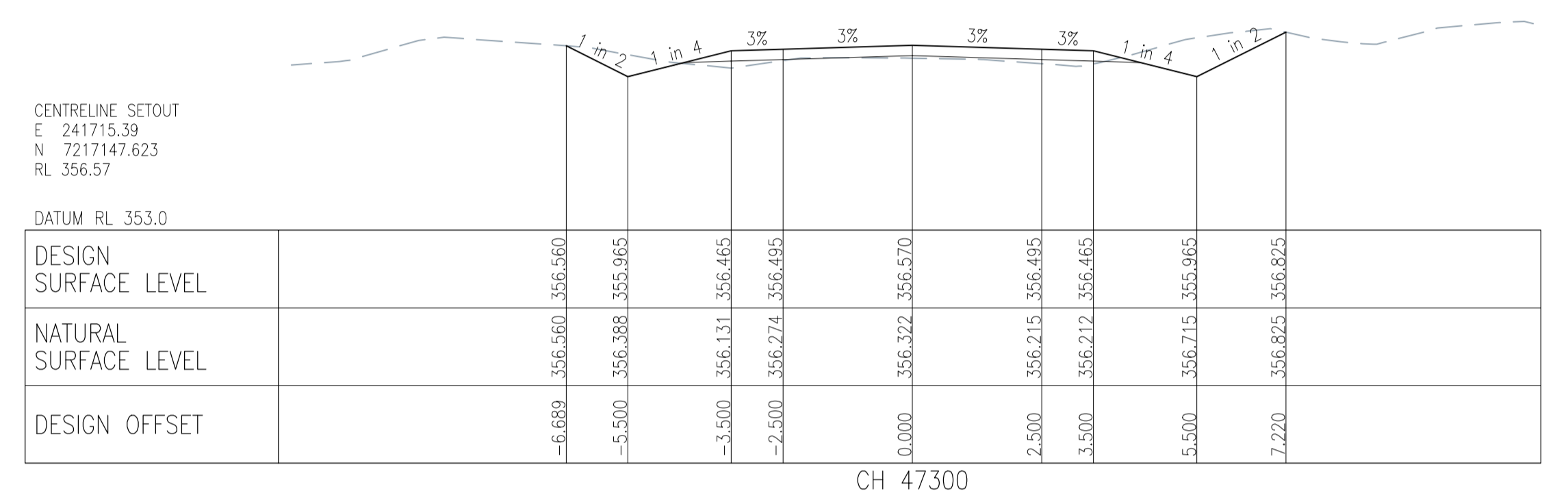
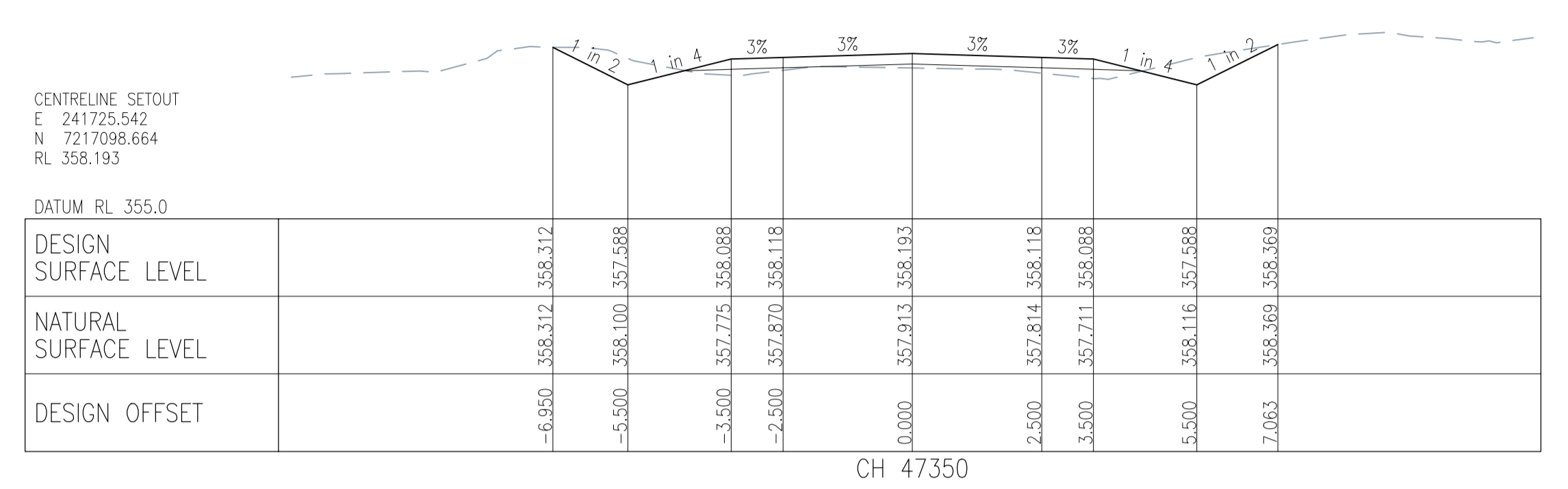
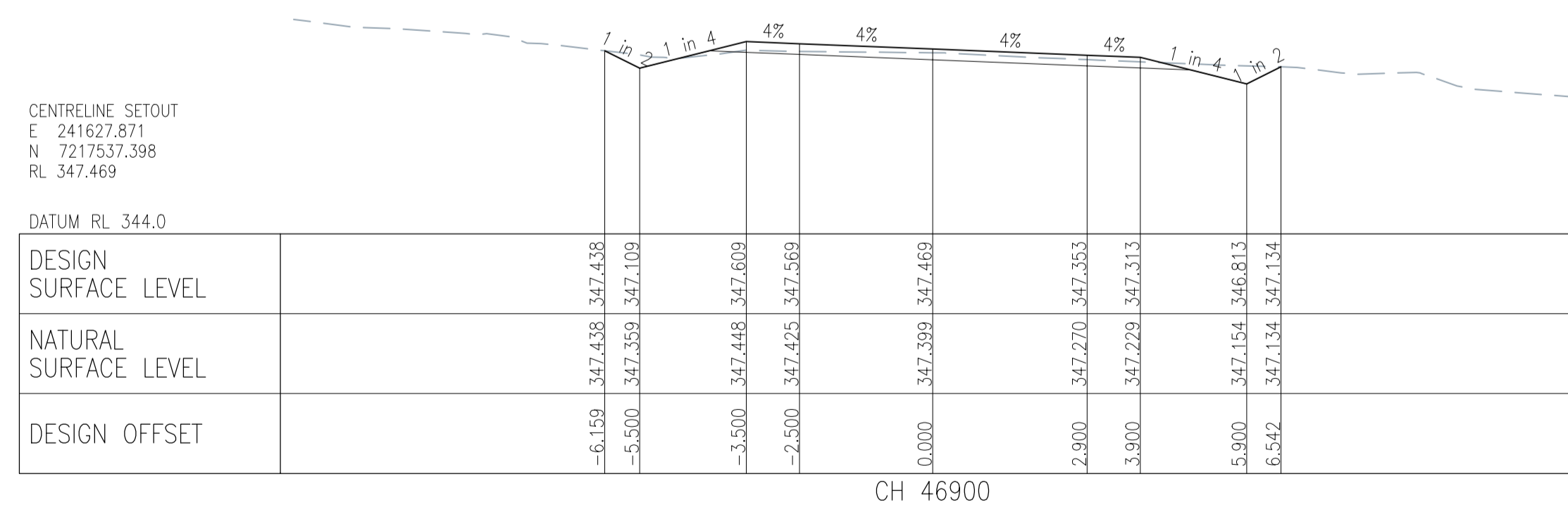
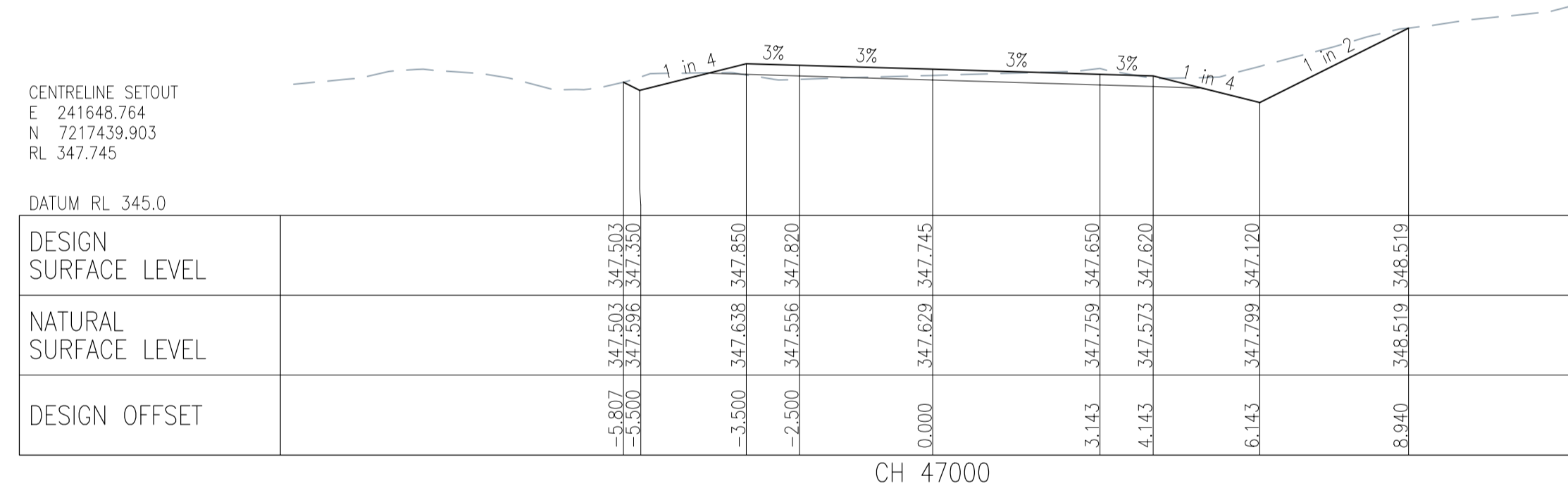
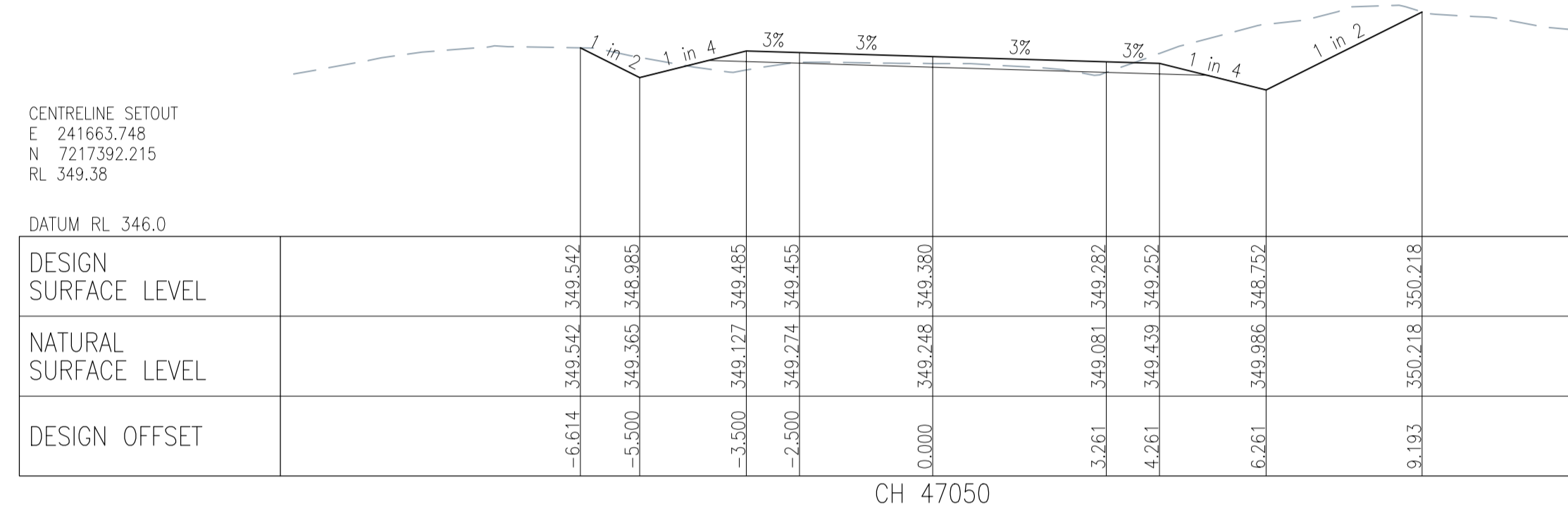
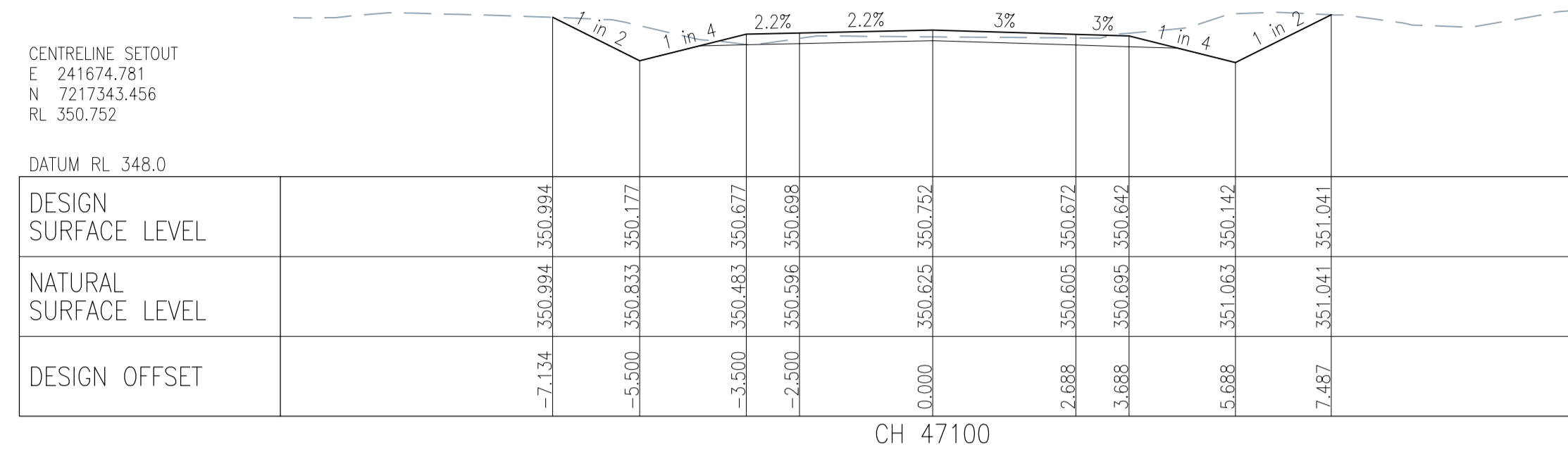

No.	Description	Reviewed	Approved	Date
1	TENDER ISSUE	-	-	23/08/2024



Client	BANANA SHIRE COUNCIL
Project	DEFENCE ROAD UPGRADE - CH 36,172 - CH68,499
Title	ANNOTATED CROSS SECTIONS SHEET 22 OF 64
Drawing No.	ARO0400-C71

Drawn	MS	Designed	MS	Approved	
Drawing Check		Design Check		RPEQ	Date

Scale (A1 size)	1:100
Drawing is not to be used for construction unless approved.	



51 Sheridan Street
Cairns Qld 4870
T (07) 4281 6897
E admin@arindustries.com.au
W www.arindustries.com.au
ABN: 49 641 461 298

TENDER ISSUE ONLY

CENTRELINE SETOUT
E 241776.303
N 7216853.872
RL 364.696

DATUM RL 361.0

DESIGN SURFACE LEVEL										
NATURAL SURFACE LEVEL										
DESIGN OFFSET										

CH 47600

CENTRELINE SETOUT
E 241766.151
N 7216902.83
RL 363.643

DATUM RL 361.0

DESIGN SURFACE LEVEL										
NATURAL SURFACE LEVEL										
DESIGN OFFSET										

CH 47550

CENTRELINE SETOUT
E 241755.999
N 7216951.789
RL 362.36

DATUM RL 359.0

DESIGN SURFACE LEVEL										
NATURAL SURFACE LEVEL										
DESIGN OFFSET										

CH 47500

CENTRELINE SETOUT
E 241735.694
N 7217049.706
RL 359.642

DATUM RL 357.0

DESIGN SURFACE LEVEL										
NATURAL SURFACE LEVEL										
DESIGN OFFSET										

CH 47400

CENTRELINE SETOUT
E 241827.065
N 7216609.079
RL 367.642

DATUM RL 364.0

DESIGN SURFACE LEVEL										
NATURAL SURFACE LEVEL										
DESIGN OFFSET										

CH 47850

CENTRELINE SETOUT
E 241816.912
N 7216658.038
RL 367.368

DATUM RL 364.0

DESIGN SURFACE LEVEL										
NATURAL SURFACE LEVEL										
DESIGN OFFSET										

CH 47800

CENTRELINE SETOUT
E 241806.76
N 7216706.996
RL 367.059

DATUM RL 364.0

DESIGN SURFACE LEVEL										
NATURAL SURFACE LEVEL										
DESIGN OFFSET										

CH 47750

CENTRELINE SETOUT
E 241796.608
N 7216755.955
RL 366.454

DATUM RL 363.0

DESIGN SURFACE LEVEL										
NATURAL SURFACE LEVEL										
DESIGN OFFSET										

CH 47700

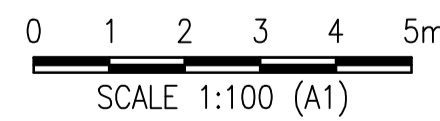

No.	Description	Reviewed	Approved	Date
1	TENDER ISSUE	-	-	23/08/2024



Client	BANANA SHIRE COUNCIL
Project	DEFENCE ROAD UPGRADE - CH 36,172 - CH68,499
Title	ANNOTATED CROSS SECTIONS SHEET 23 OF 64
Drawing No.	ARO0400-C72

Drawn	MS
Designed	MS
Approved	RPEQ
Date	

Scale (A1 size)	1:100
Drawing is not to be used for construction unless approved.	



51 Sheridan Street
Cairns Qld 4870
T (07) 4281 6897
E admin@aroindustries.com.au
W www.aroindustries.com.au
ABN: 49 641 461 298

TENDER ISSUE ONLY

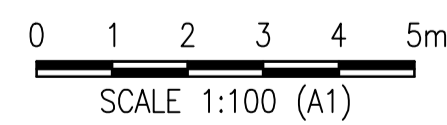
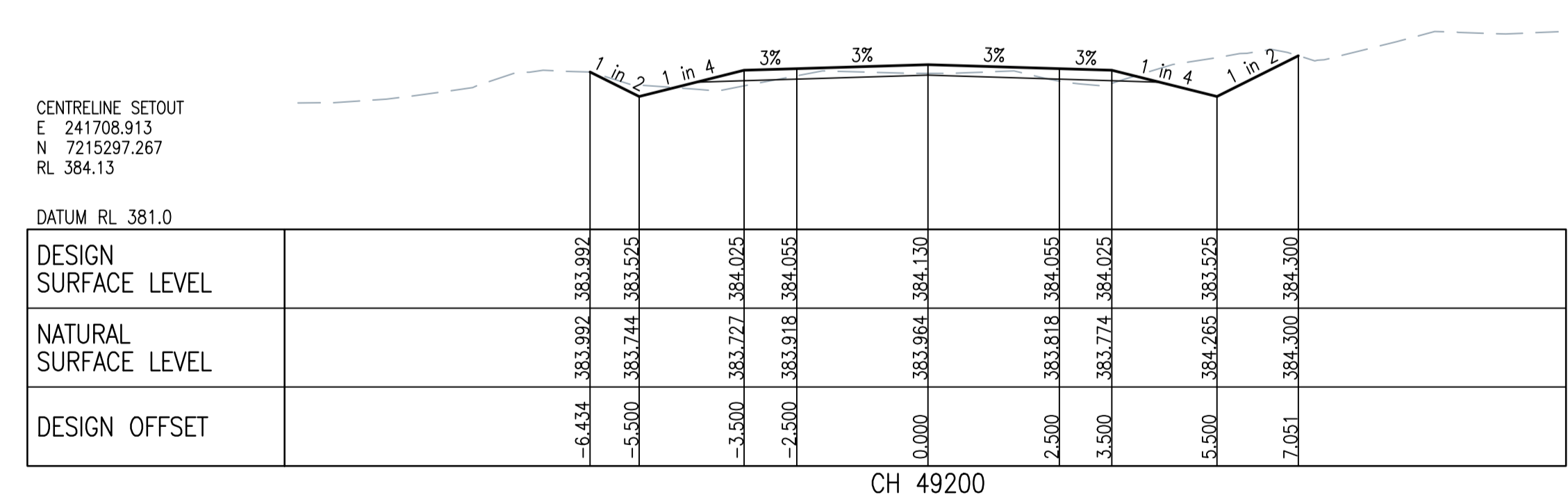
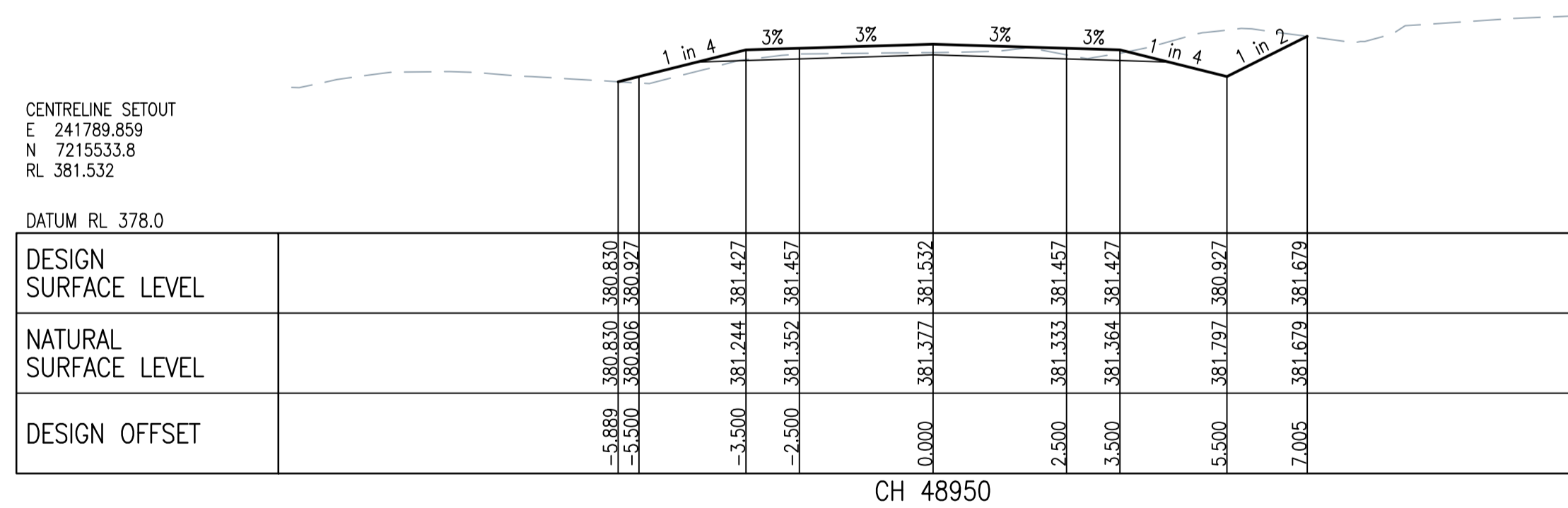
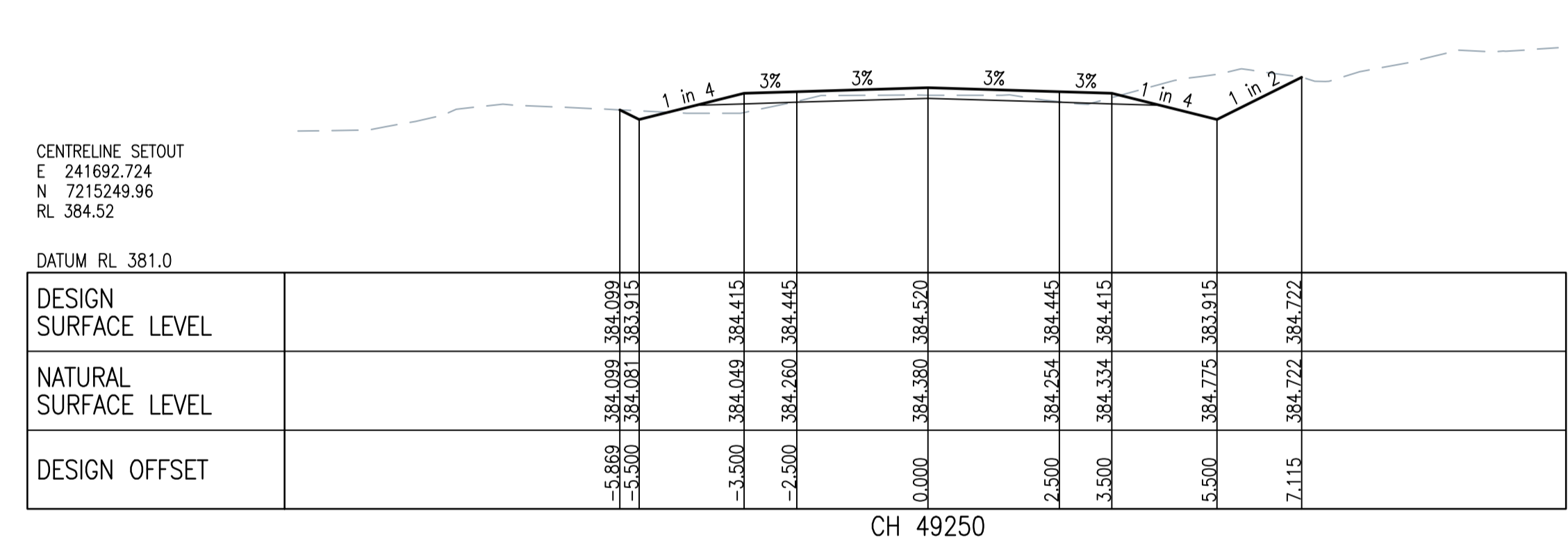
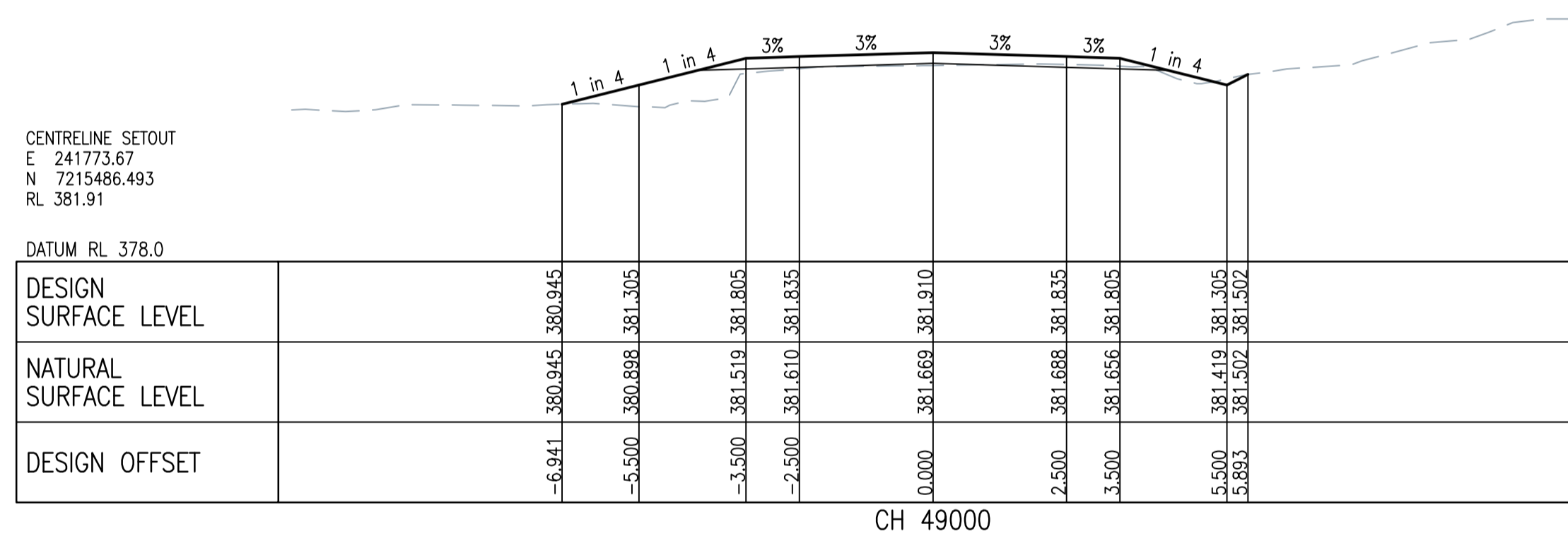
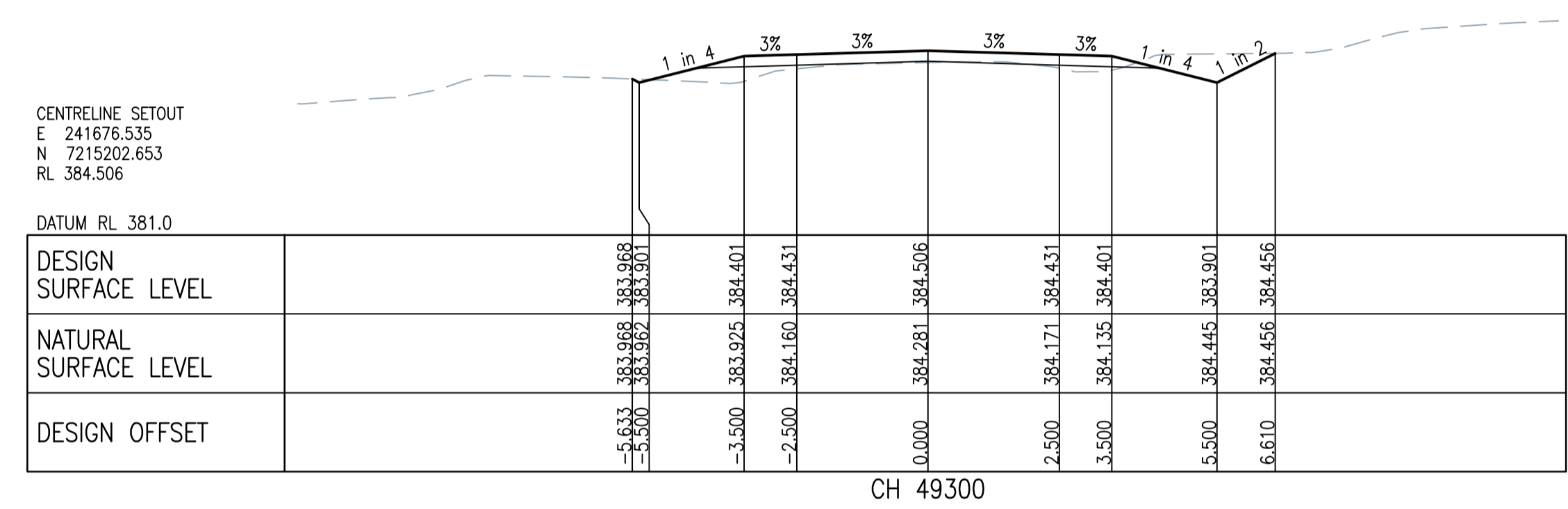
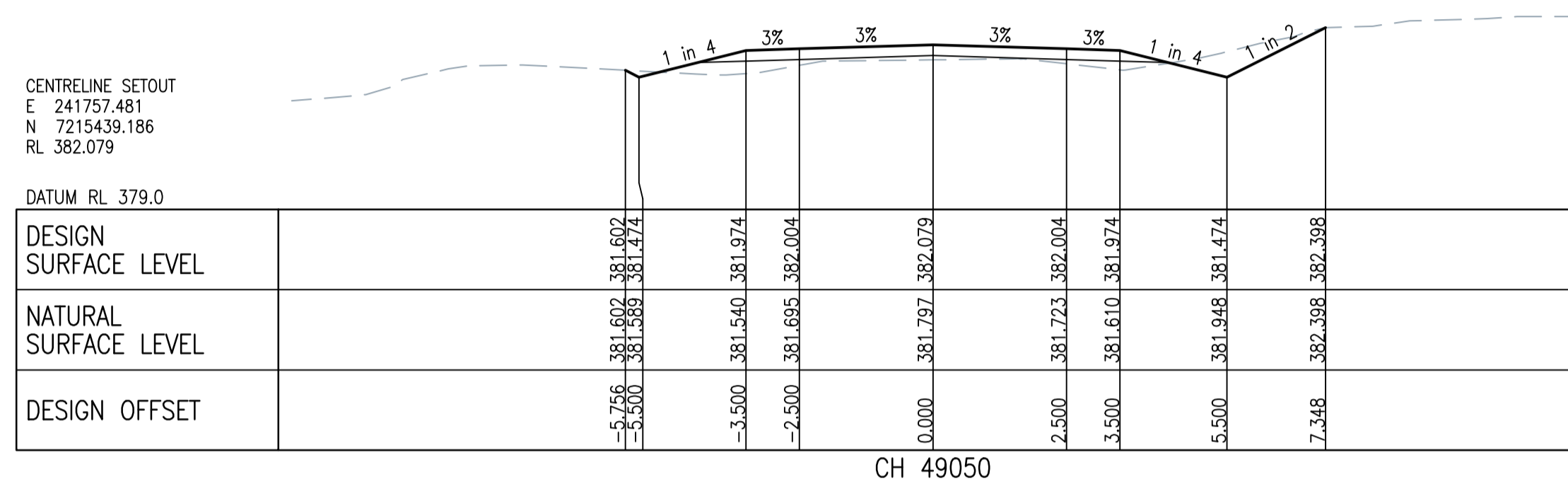
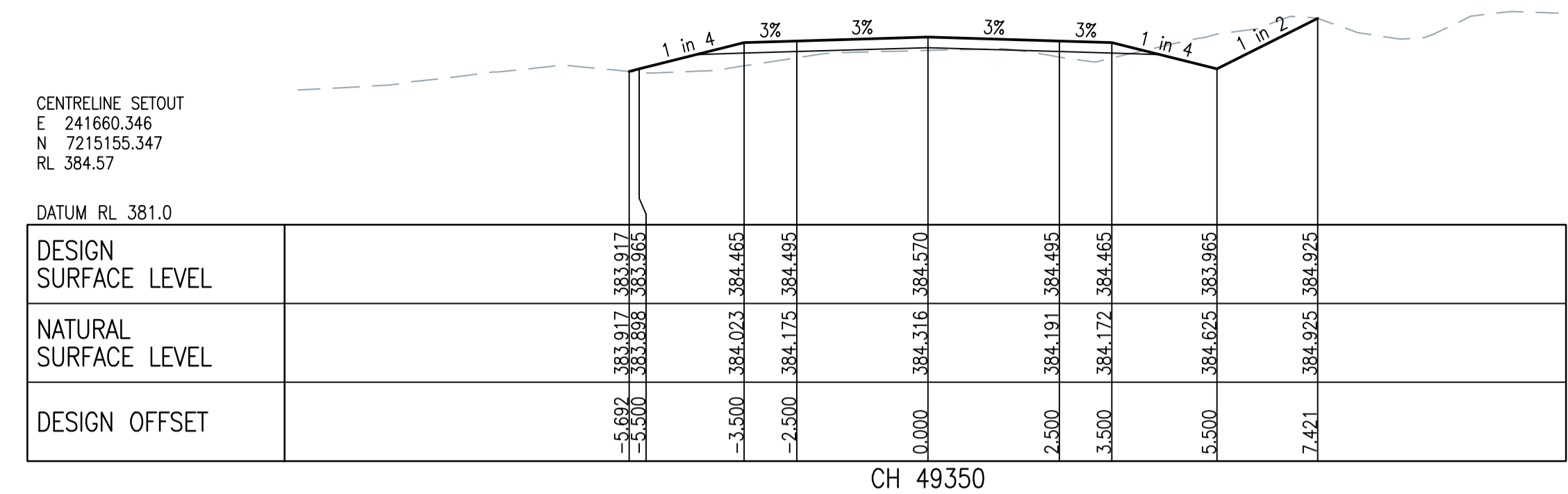
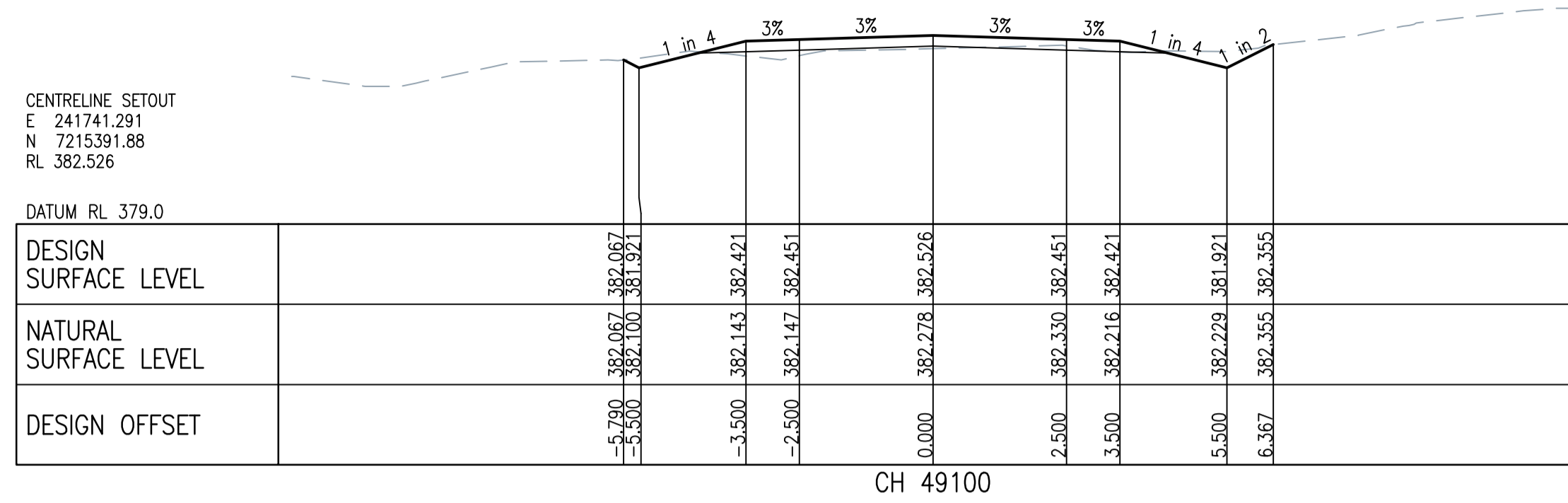

No.	Description	Reviewed	Approved	Date
1	TENDER ISSUE	-	-	23/08/2024



Client	BANANA SHIRE COUNCIL
Project	DEFENCE ROAD UPGRADE - CH 36,172 - CH68,499
Title	ANNOTATED CROSS SECTIONS SHEET 26 OF 64

Drawn	MS	Designed	MS	Approved	
Drawing Check		Design Check		RPEQ	Date

Scale (A1 size)
1:100

Drawing is not to be used for construction unless approved.

51 Sheridan Street
Cairns Qld 4870
T (07) 4281 6897
E admin@arindustries.com.au
W www.arindustries.com.au
ABN: 49 641 461 298

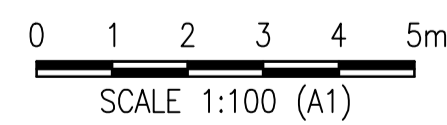
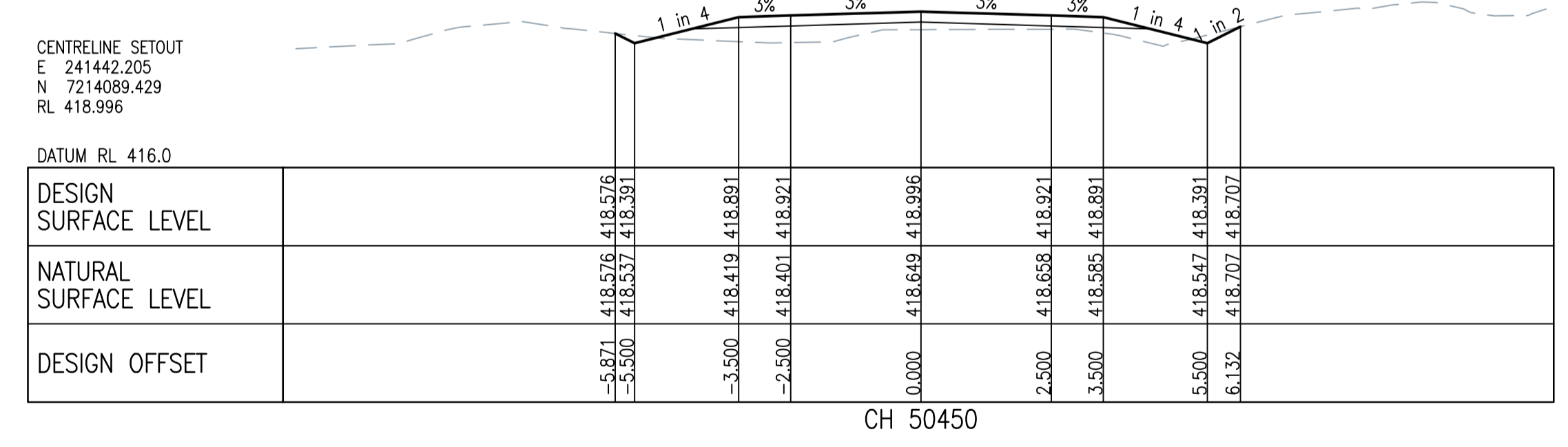
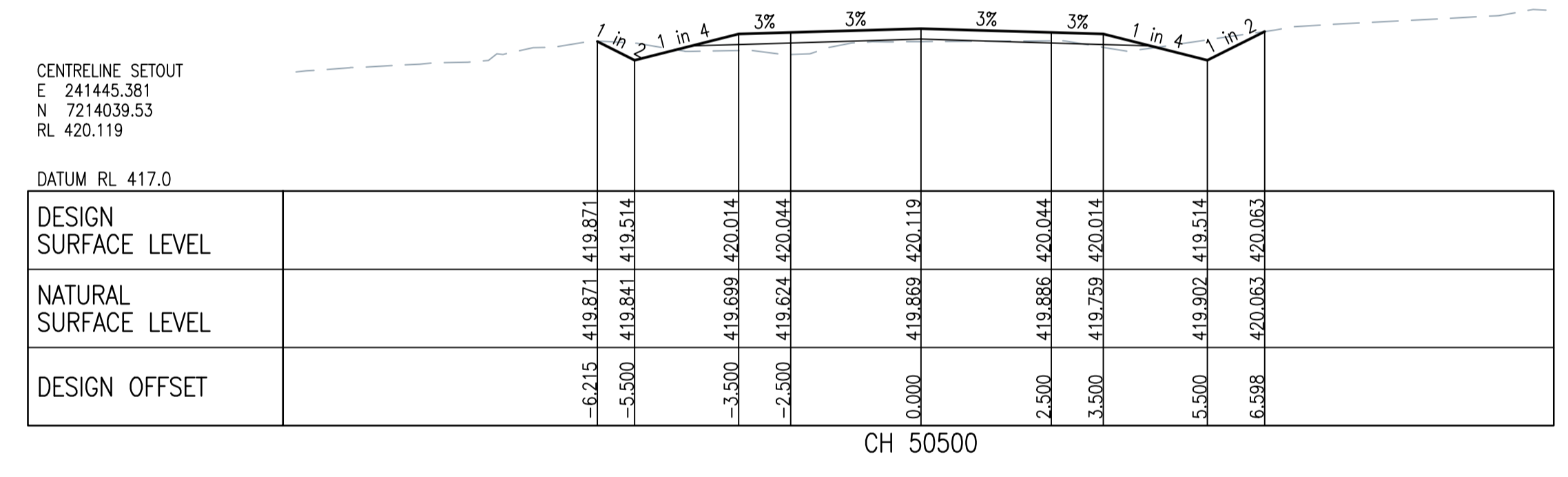
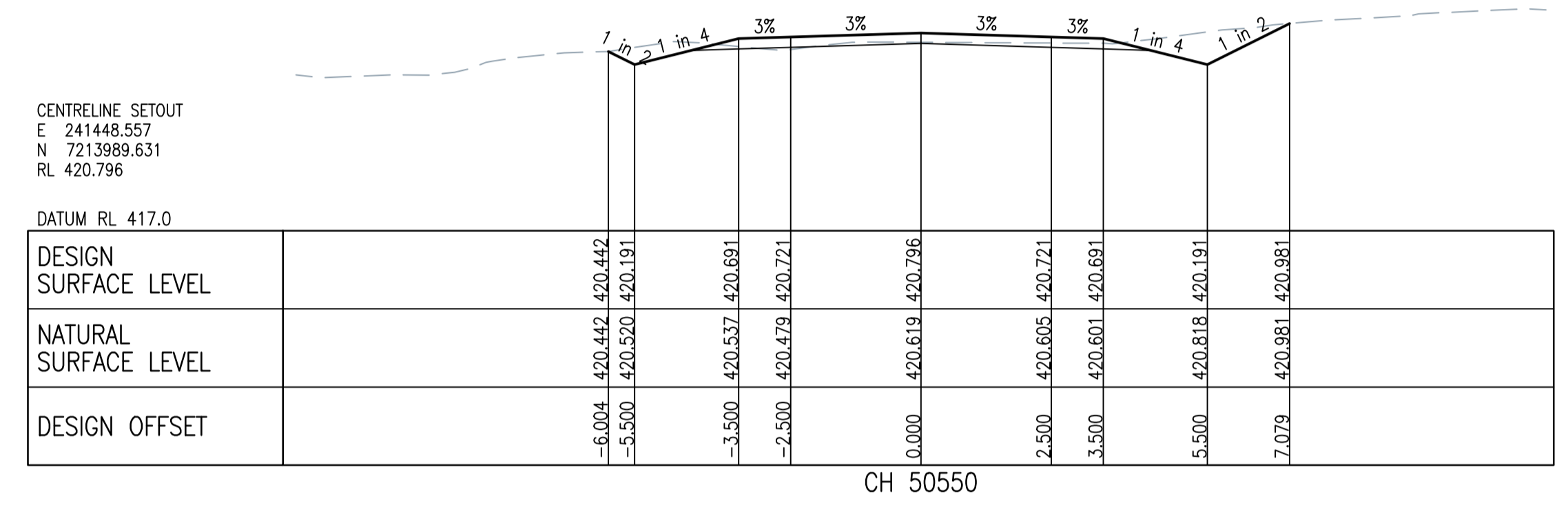
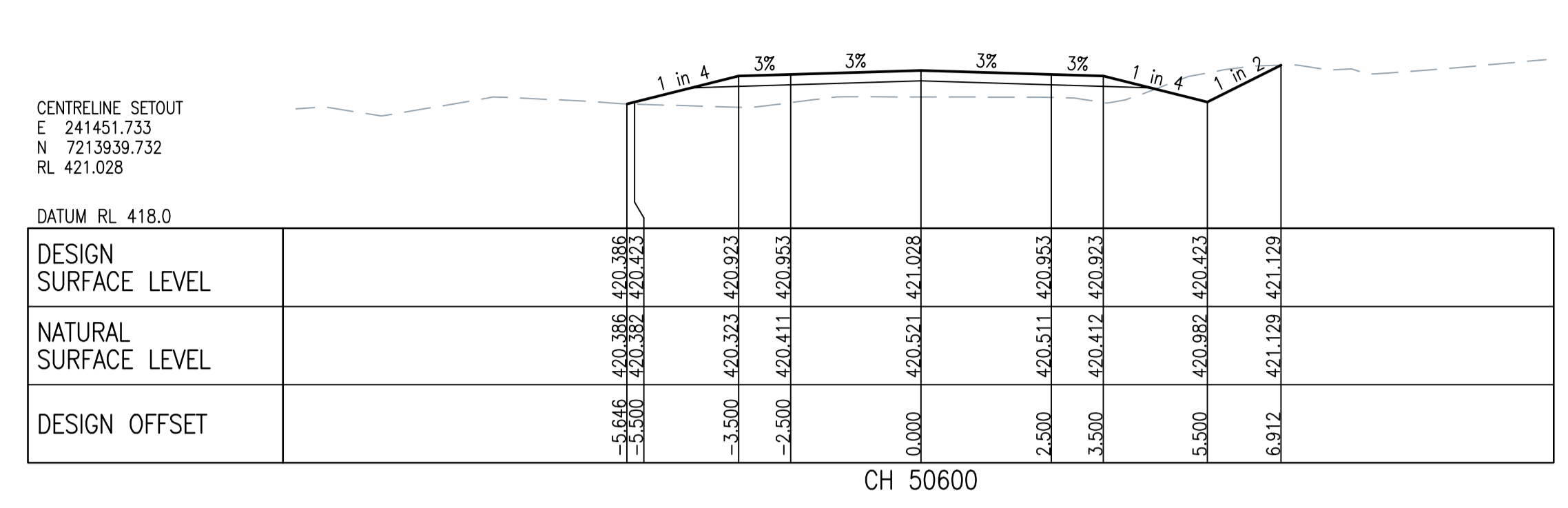
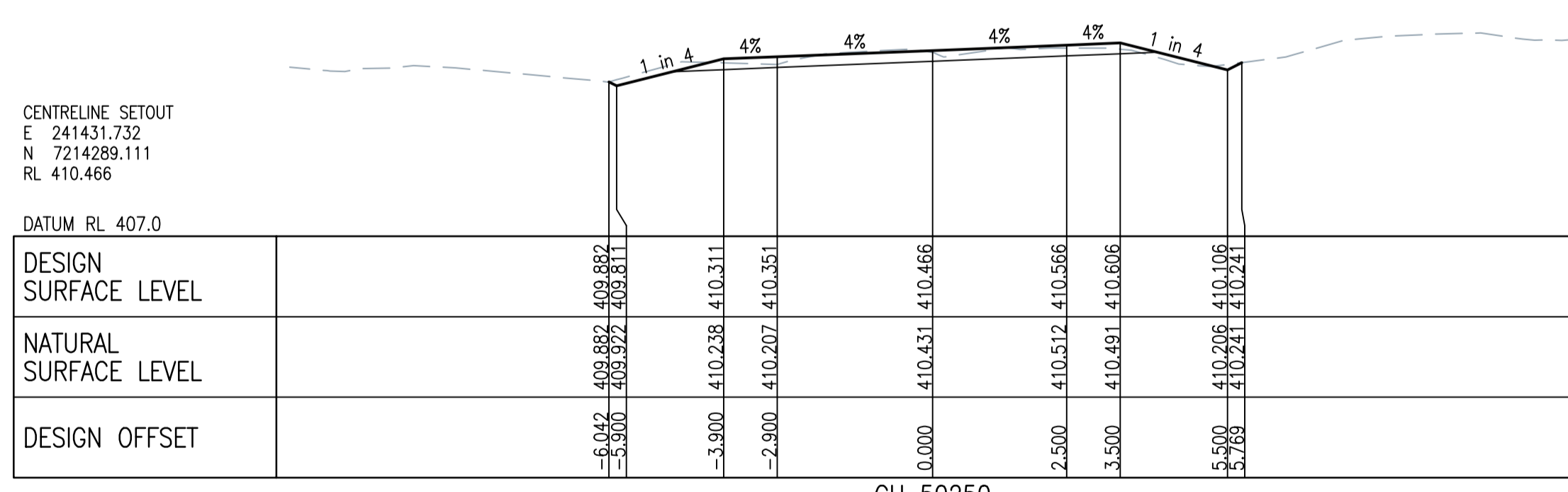
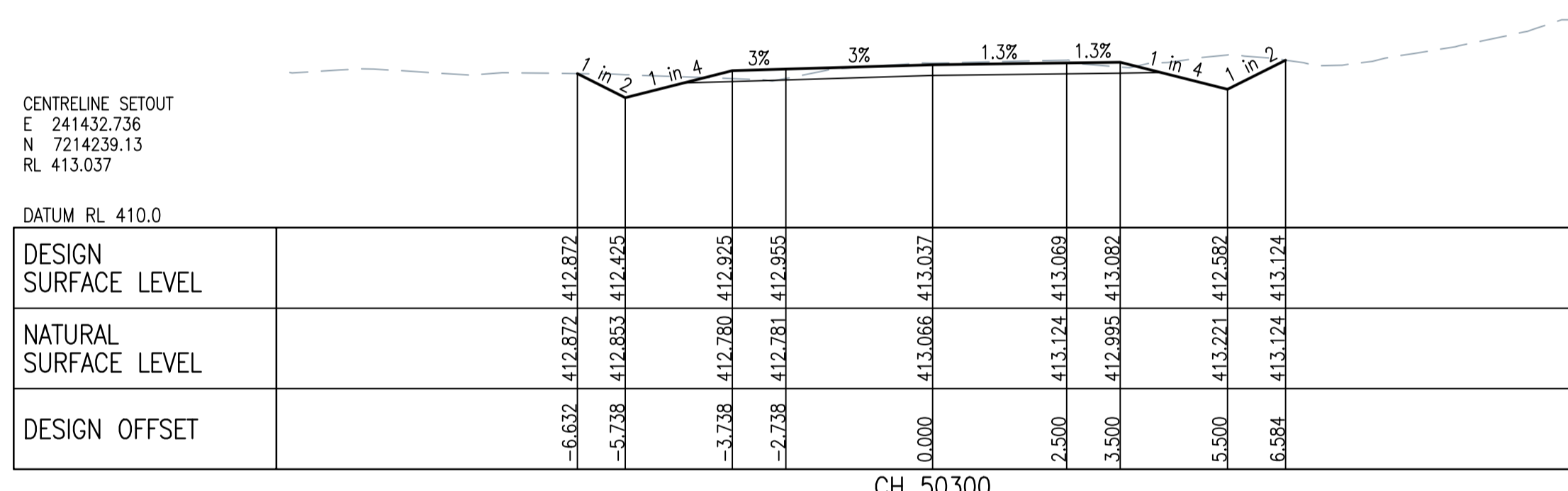
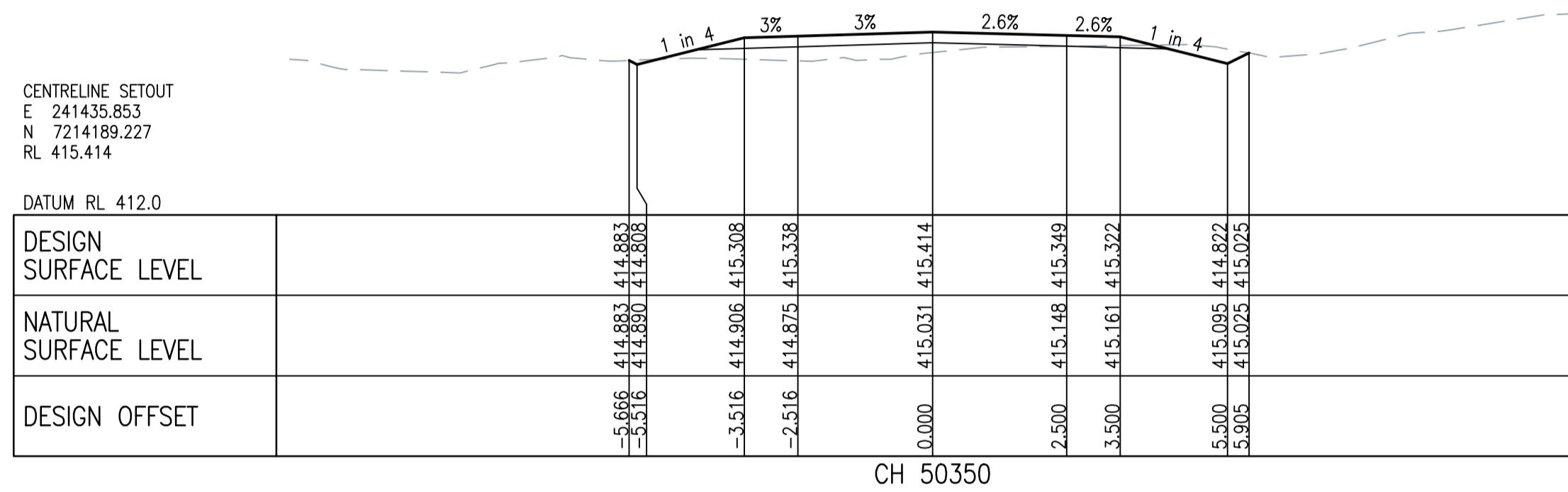
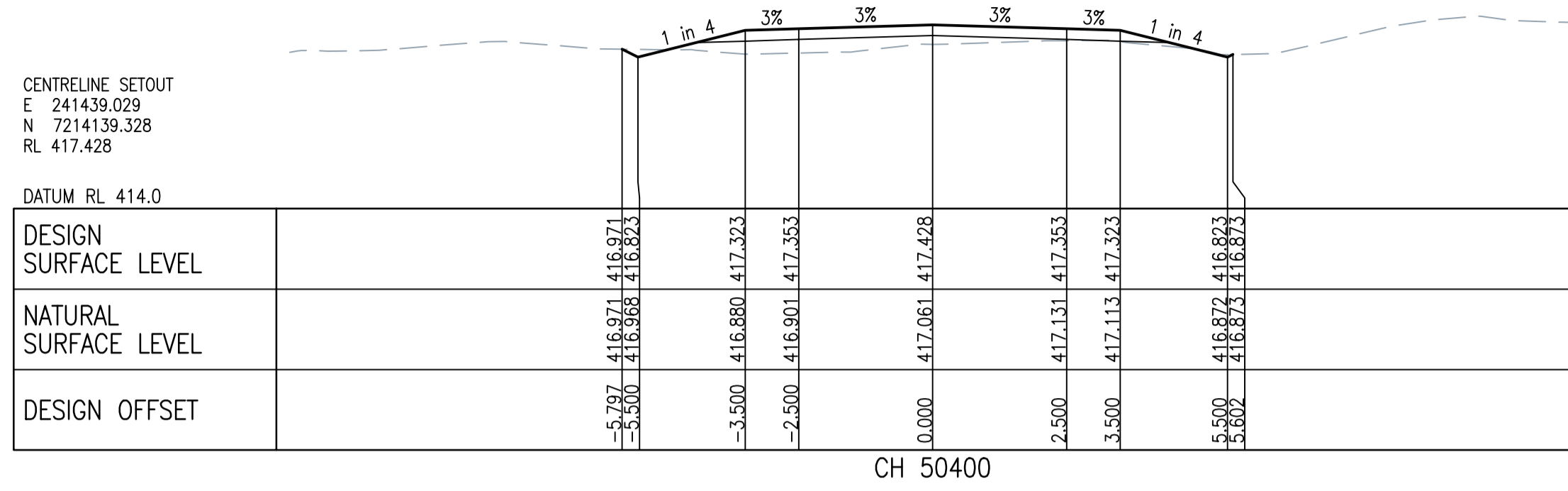

No.	Description	Reviewed	Approved	Date
1	TENDER ISSUE	-	-	23/08/2024



Client: BANANA SHIRE COUNCIL
Project: DEFENCE ROAD UPGRADE - CH 36,172 - CH 68,499
Title: ANNOTATED CROSS SECTIONS SHEET 29 OF 64

Drawn	Designed	Approved
MS	MS	
Drawing Check	Design Check	RPEQ
		Date

Scale (A1 size)
1:100

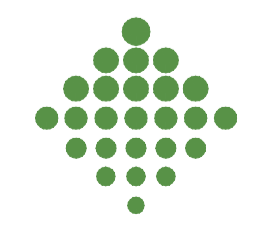

ARO

51 Sheridan Street
Cairns Qld 4870
T (07) 4281 6897
E admin@arindustries.com.au
W www.arindustries.com.au
ABN: 49 641 461 298

TENDER ISSUE ONLY

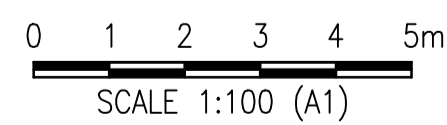
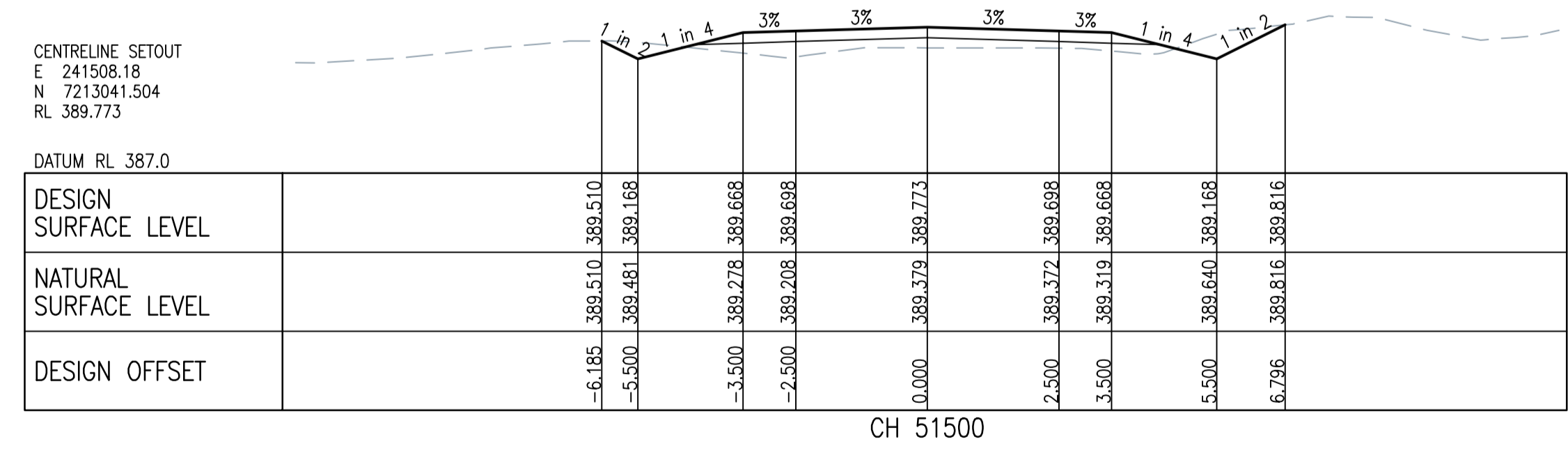
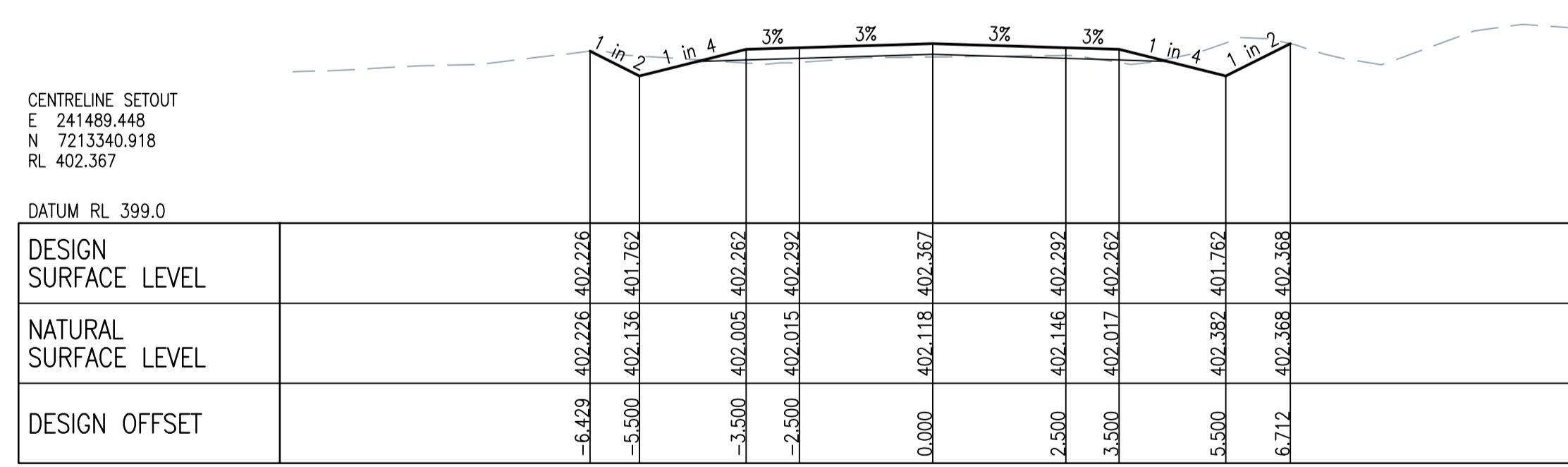
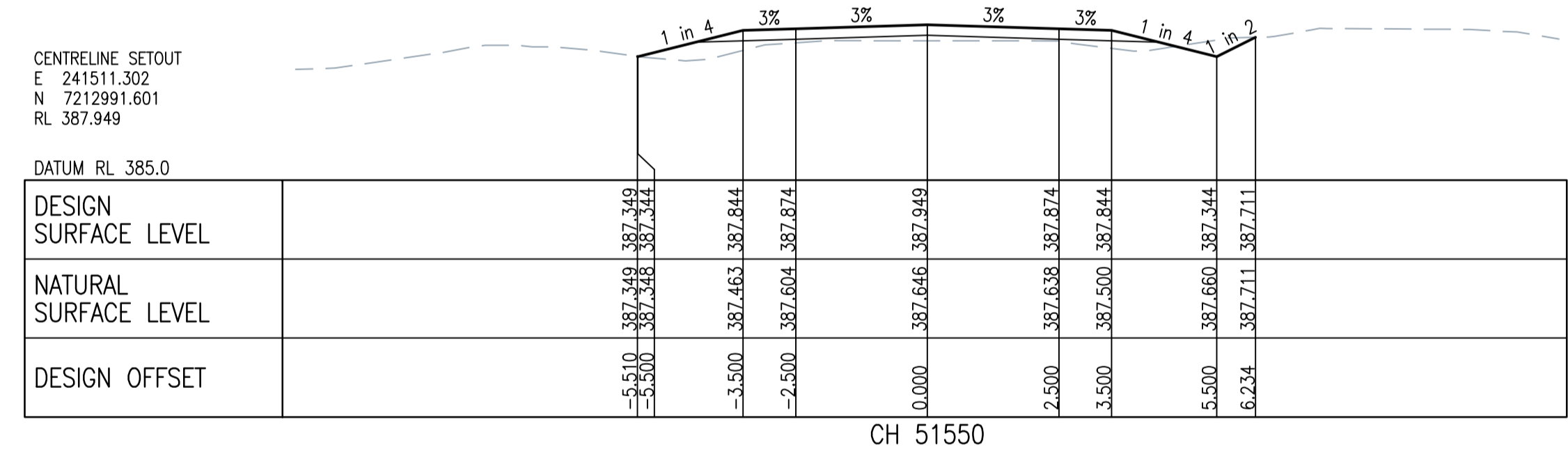
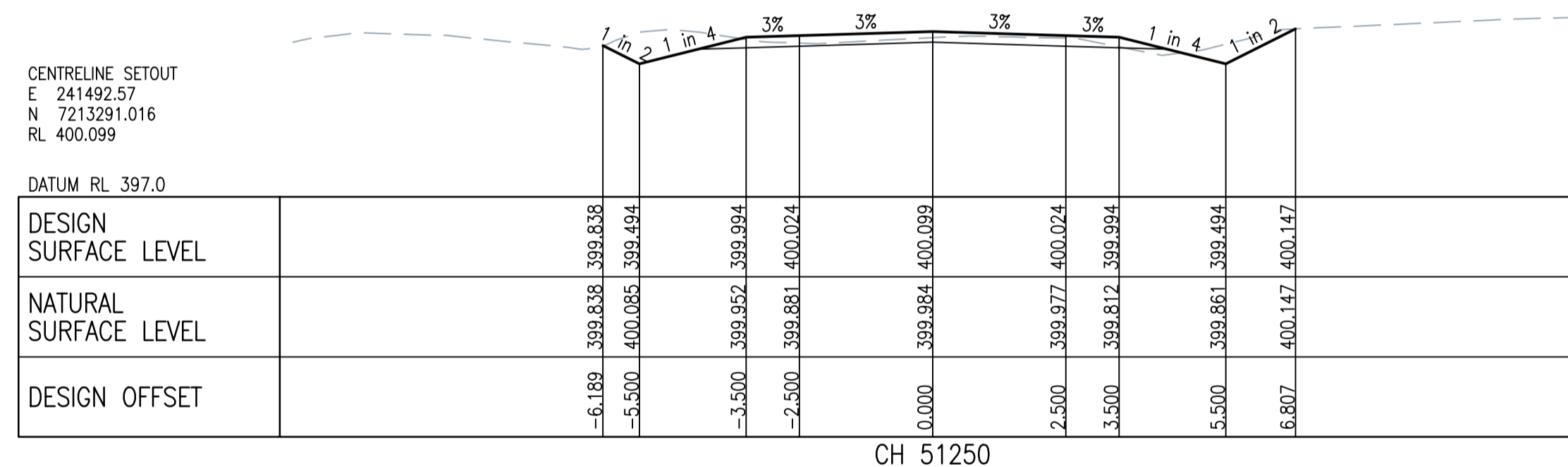
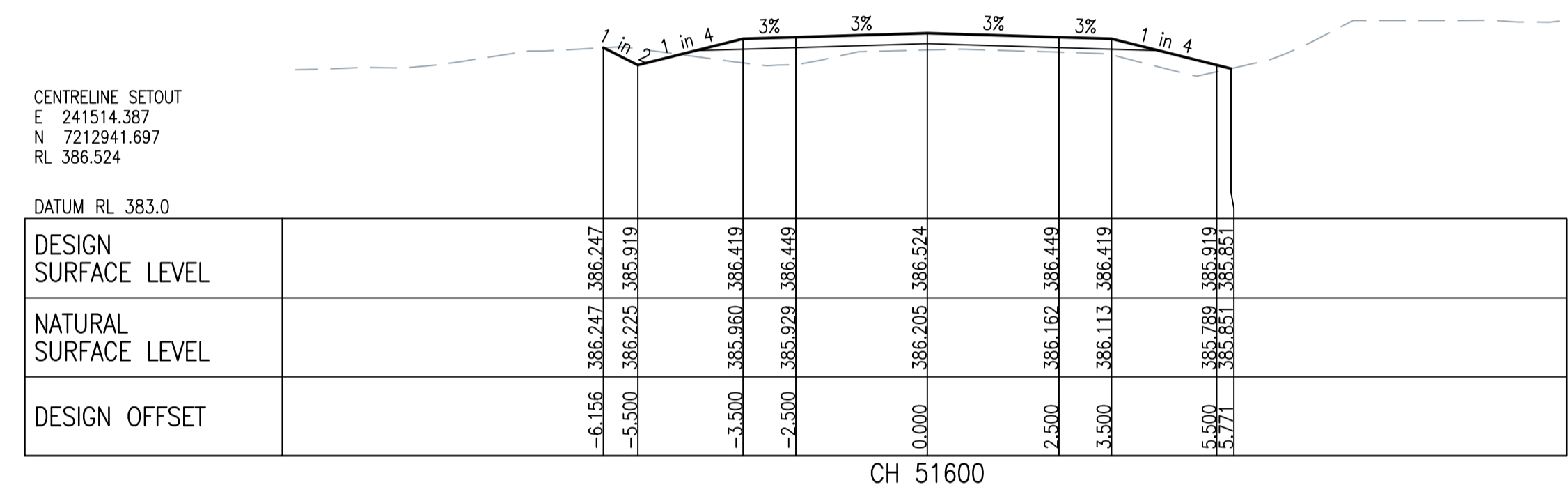
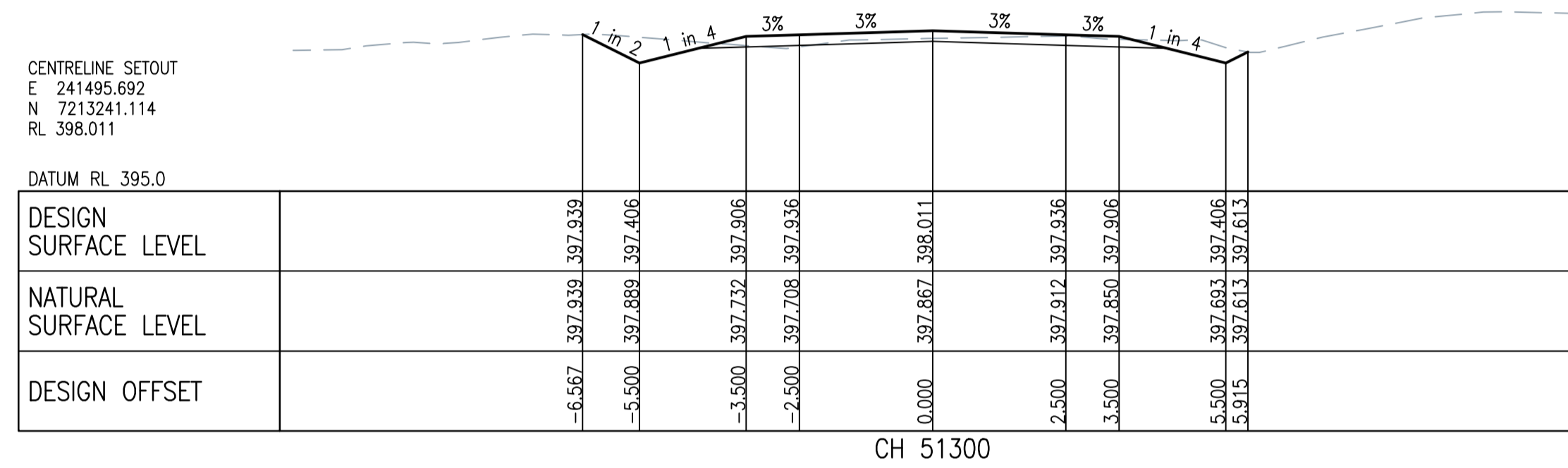
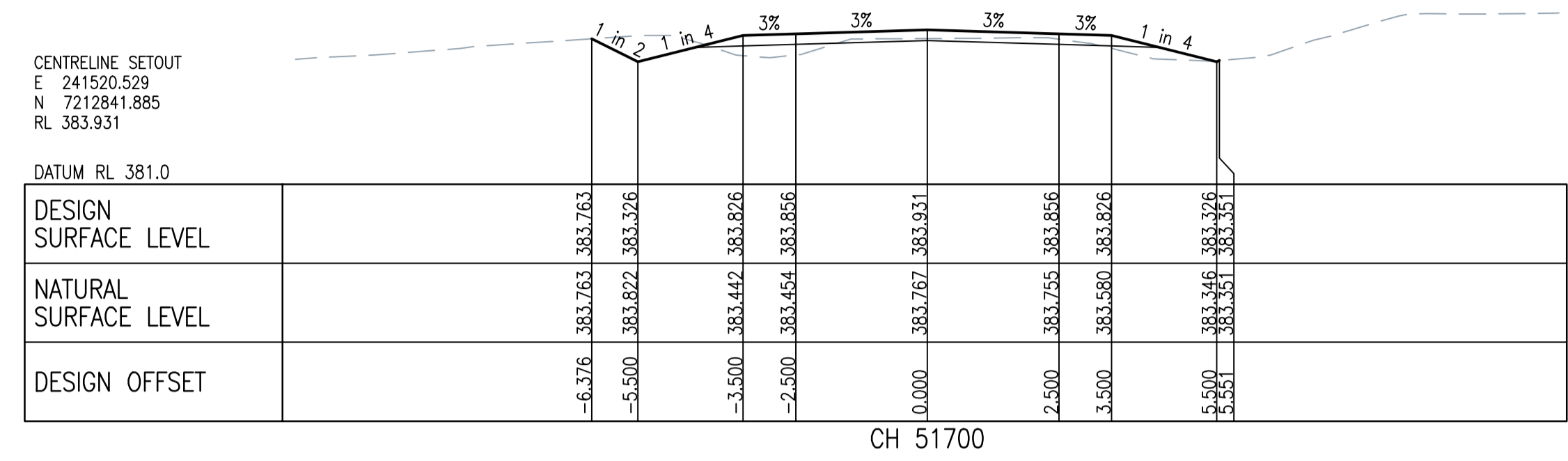
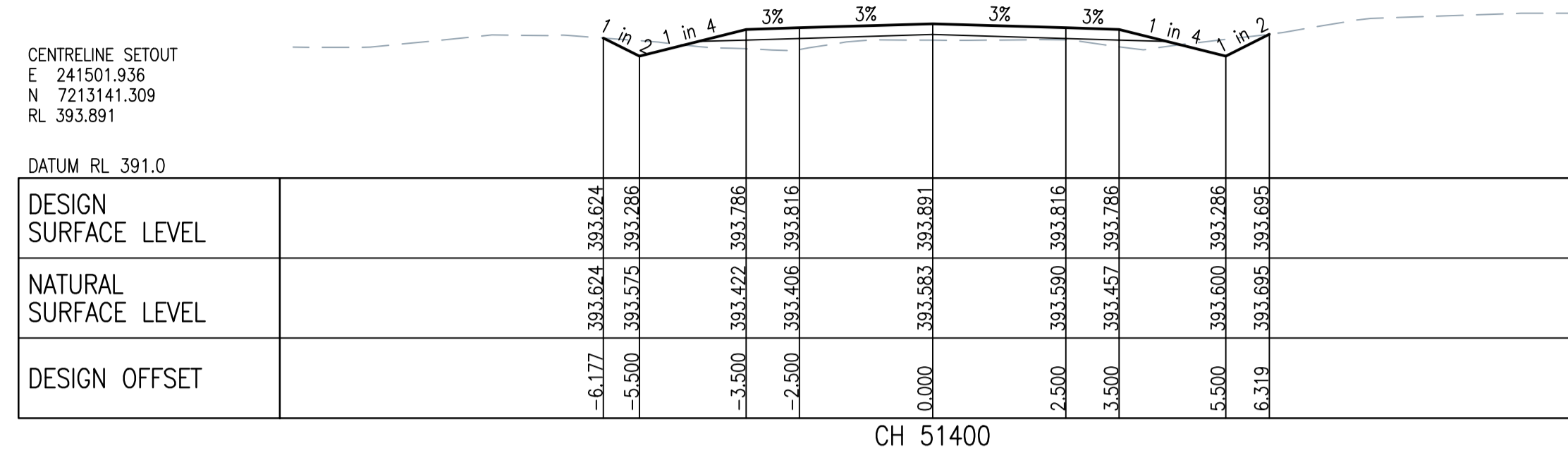

TENDER ISSUE ONLY

No.	Description	Reviewed	Approved	Date
1	TENDER ISSUE			23/08/2024



Client	BANANA SHIRE COUNCIL
Project	DEFENCE ROAD UPGRADE - CH 36,172 - CH68,499
Title	ANNOTATED CROSS SECTIONS SHEET 31 OF 64
Drawing No.	ARO0400-C80

Drawn	MS	Designed	MS	Approved	
Drawing Check		Design Check		RPEQ	Date

Scale (A1 size)
1:100

Drawing is not to be used for construction unless approved.

51 Sheridan Street
Cairns Qld 4870
T (07) 4281 6897
E admin@aroindustries.com.au
W www.aroindustries.com.au
ABN: 49 641 461 298

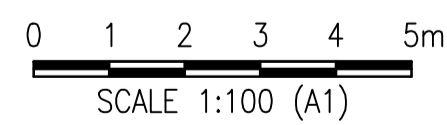
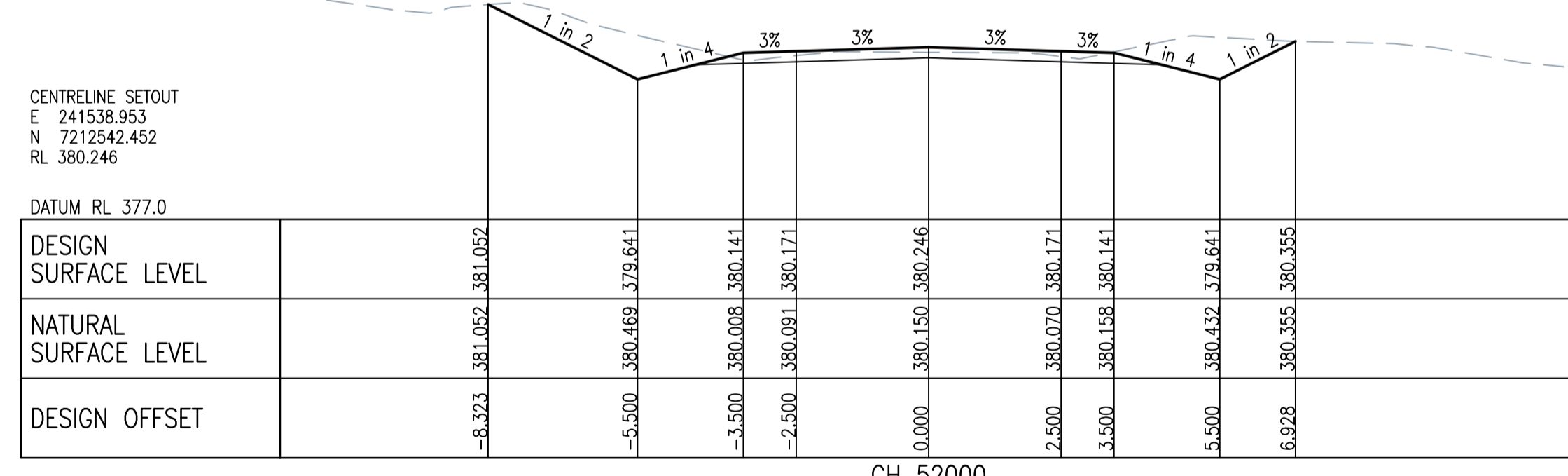
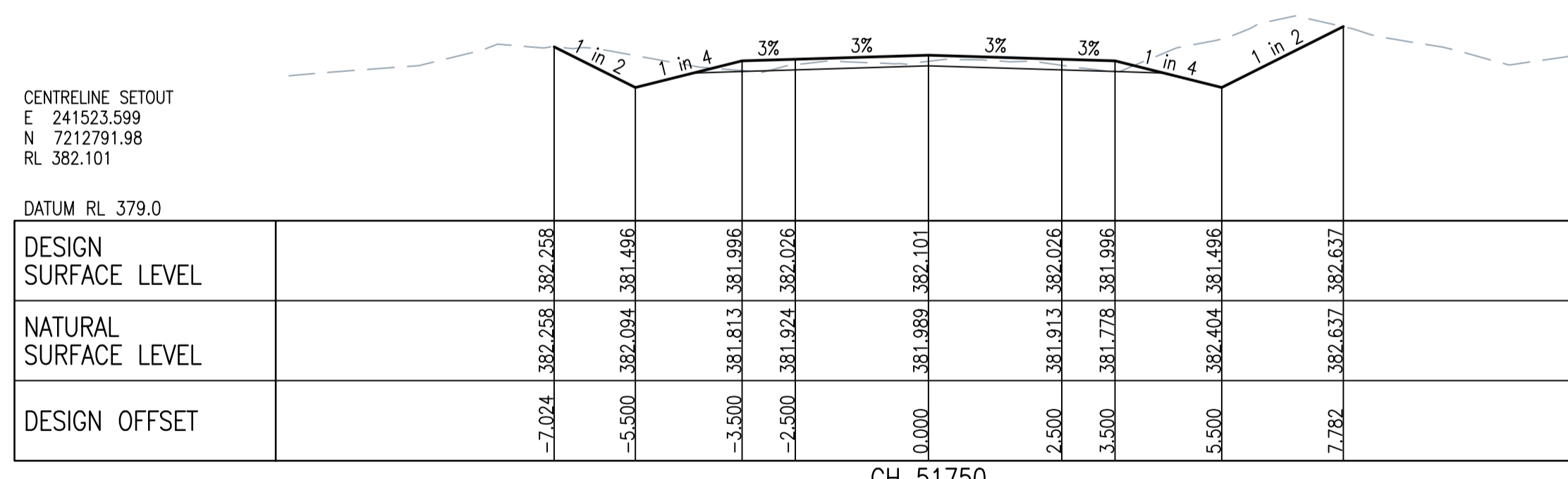
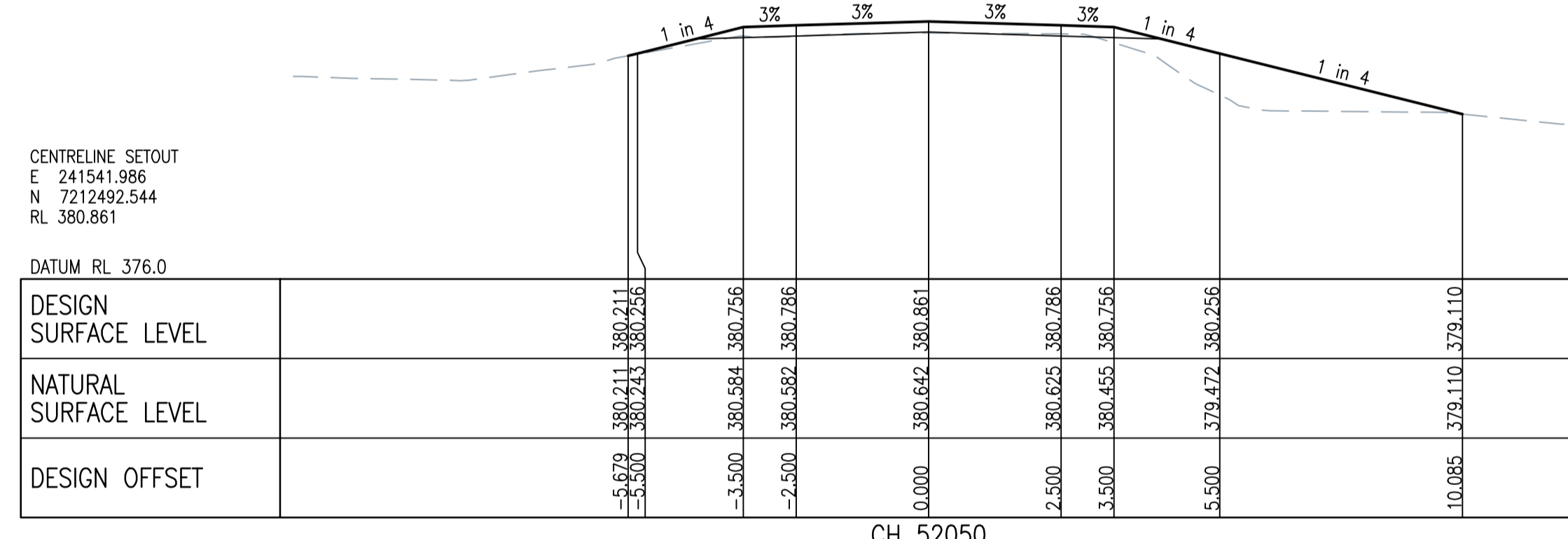
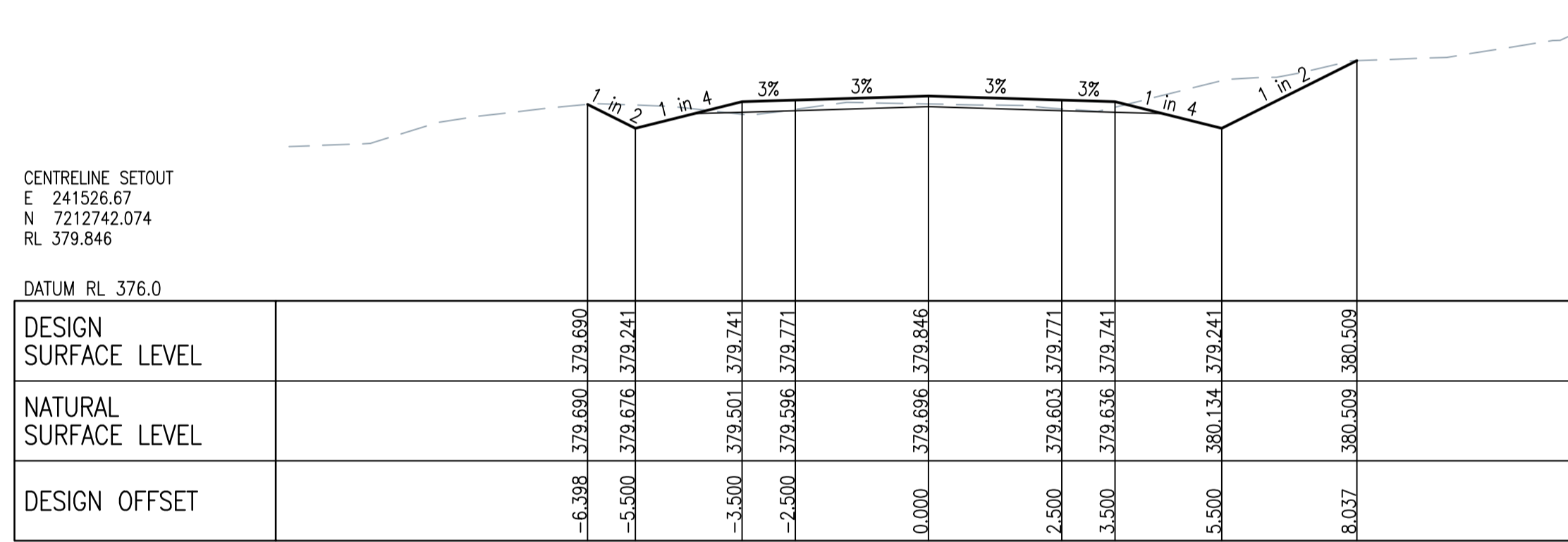
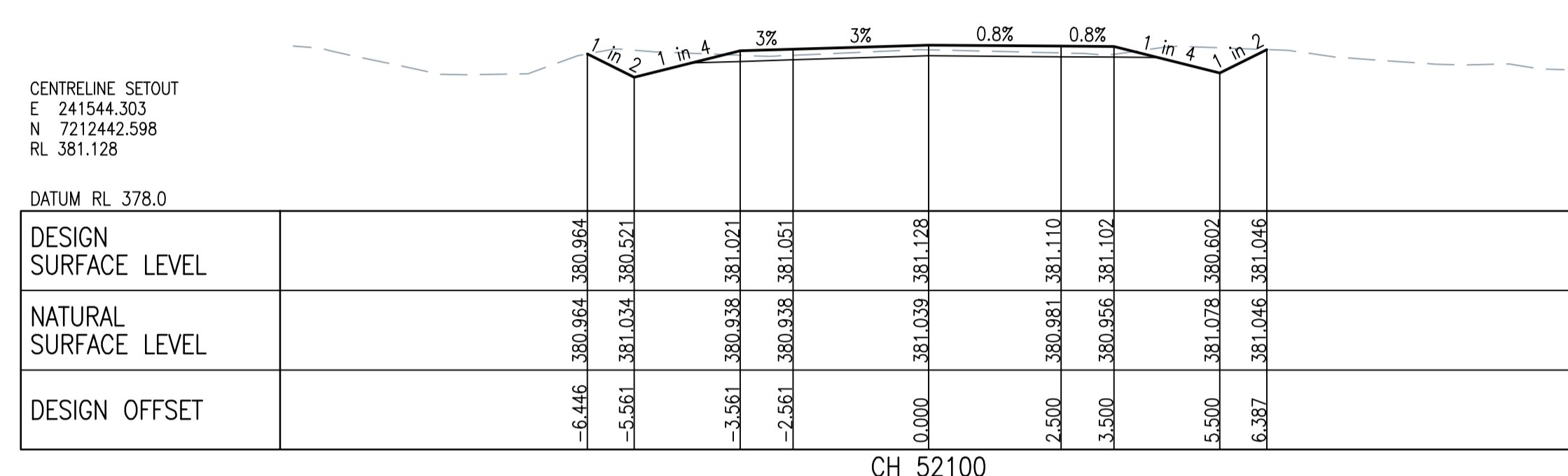
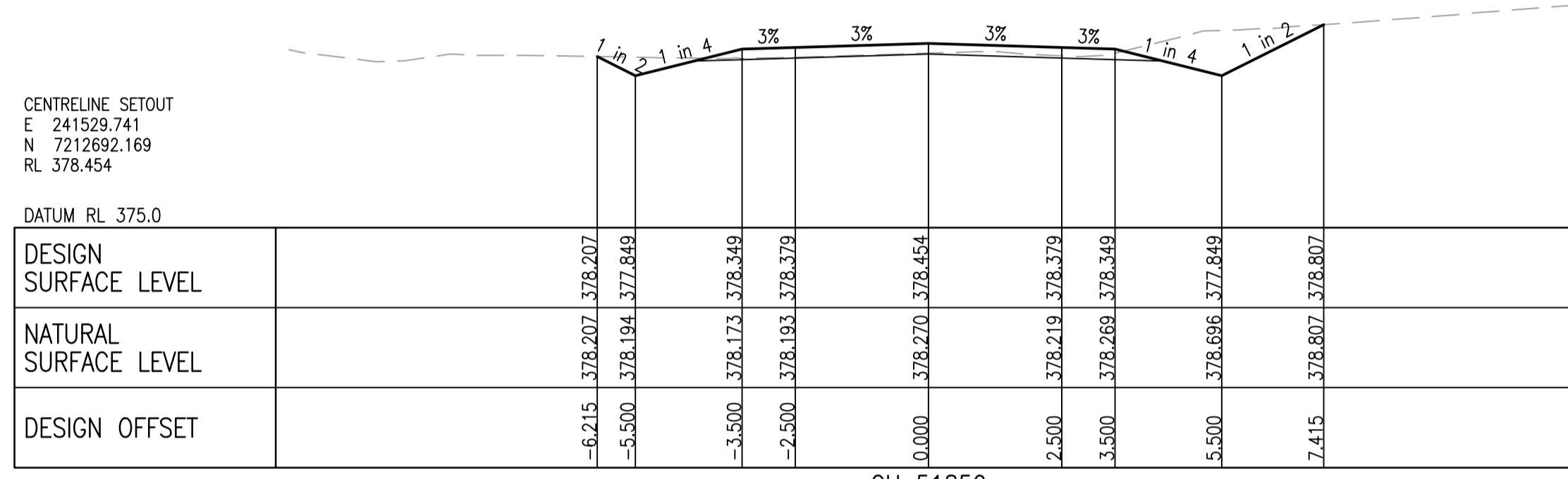
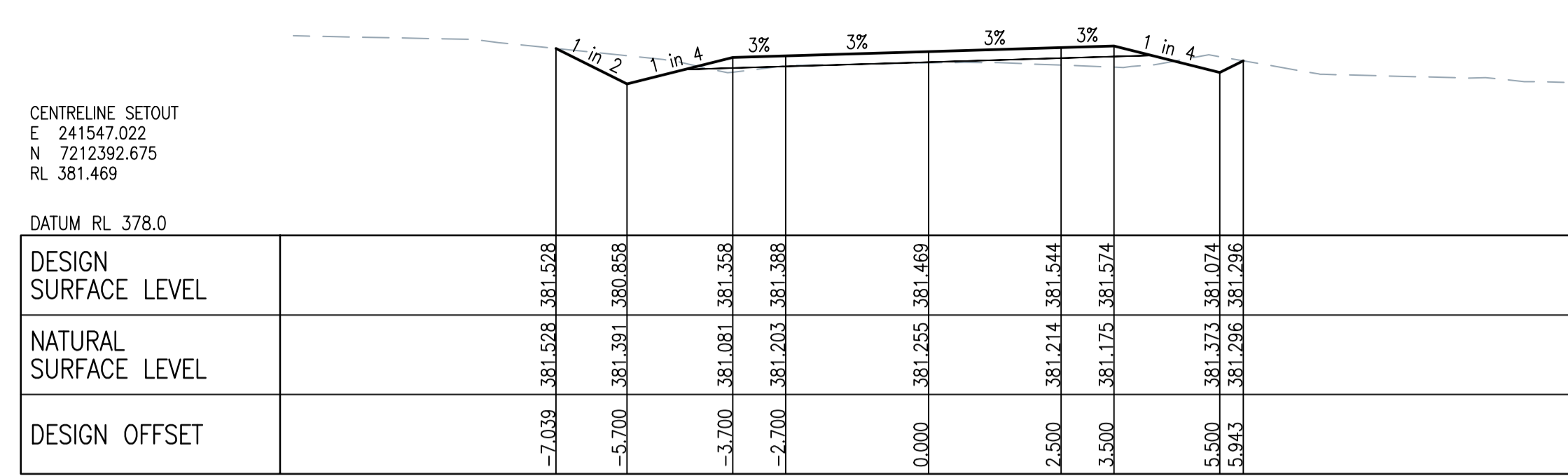
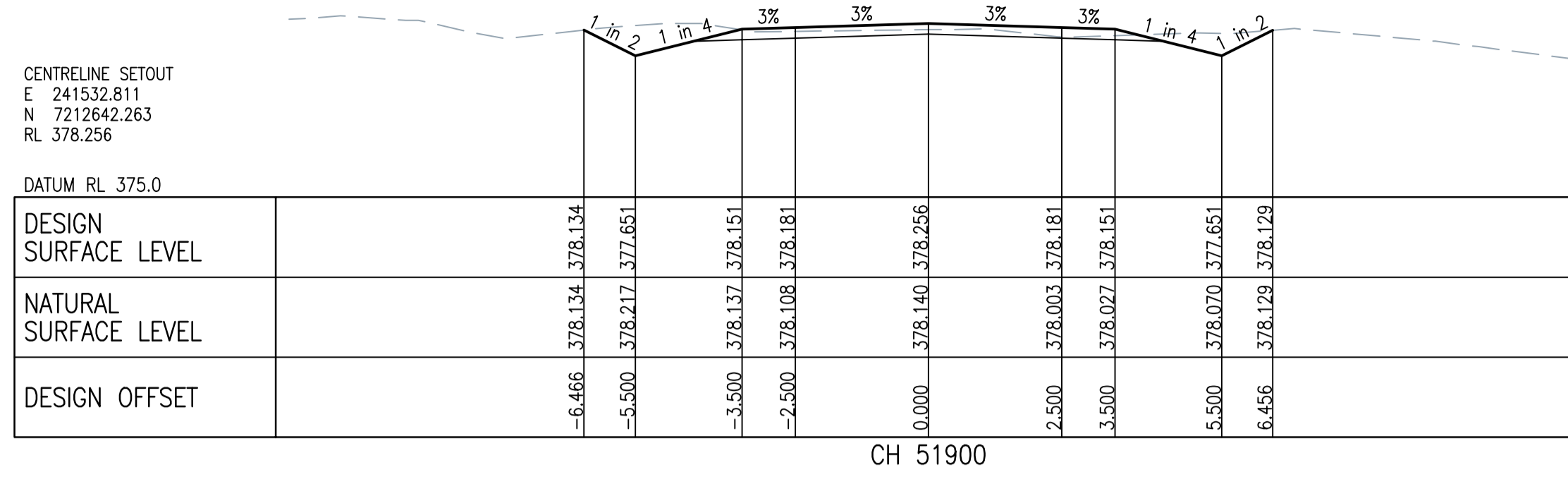

TENDER ISSUE ONLY

No.	Description	Reviewed	Approved	Date
1	TENDER ISSUE	-	-	23/08/2024



Client	BANANA SHIRE COUNCIL
Project	DEFENCE ROAD UPGRADE - CH 36,172 - CH68,499
Title	ANNOTATED CROSS SECTIONS SHEET 32 OF 64
Drawing No.	ARO0400-C81

Drawn	MS	Designed	MS	Approved		Scale (A1 size)	1:100
Drawing Check		Design Check		RPEQ	Date	Drawing is not to be used for construction unless approved.	

51 Sheridan Street
Cairns Qld 4870
T (07) 4281 6897
E admin@arindustries.com.au
W www.arindustries.com.au
ABN: 49 641 461 298

CENTRELINE SETOUT
E 241574.855
N 7212194.707
RL 384.695

DATUM RL 381.0

DESIGN SURFACE LEVEL									
NATURAL SURFACE LEVEL									
DESIGN OFFSET									

CH 52350

CENTRELINE SETOUT
E 241614.358
N 7211947.869
RL 392.667

DATUM RL 390.0

DESIGN SURFACE LEVEL									
NATURAL SURFACE LEVEL									
DESIGN OFFSET									

CH 52600

CENTRELINE SETOUT
E 241566.718
N 7212244.04
RL 383.968

DATUM RL 381.0

DESIGN SURFACE LEVEL									
NATURAL SURFACE LEVEL									
DESIGN OFFSET									

CH 52300

CENTRELINE SETOUT
E 241599.479
N 7212046.742
RL 390.165

DATUM RL 387.0

DESIGN SURFACE LEVEL									
NATURAL SURFACE LEVEL									
DESIGN OFFSET									

CH 52500

CENTRELINE SETOUT
E 241558.6
N 7212293.377
RL 383.122

DATUM RL 380.0

DESIGN SURFACE LEVEL									
NATURAL SURFACE LEVEL									
DESIGN OFFSET									

CH 52250

CENTRELINE SETOUT
E 241591.269
N 7212096.063
RL 388.332

DATUM RL 385.0

DESIGN SURFACE LEVEL									
NATURAL SURFACE LEVEL									
DESIGN OFFSET									

CH 52450

CENTRELINE SETOUT
E 241551.776
N 7212342.905
RL 382.159

DATUM RL 379.0

DESIGN SURFACE LEVEL									
NATURAL SURFACE LEVEL									
DESIGN OFFSET									

CH 52200

CENTRELINE SETOUT
E 241583.059
N 7212145.384
RL 386.203

DATUM RL 383.0

DESIGN SURFACE LEVEL									
NATURAL SURFACE LEVEL									
DESIGN OFFSET									

CH 52400

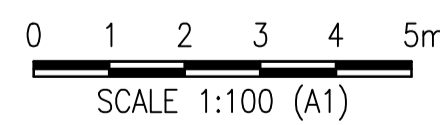

No.	Description	Reviewed	Approved	Date
1	TENDER ISSUE			23/08/2024



Client	BANANA SHIRE COUNCIL
Project	DEFENCE ROAD UPGRADE - CH 36,172 - CH68,499
Title	ANNOTATED CROSS SECTIONS SHEET 33 OF 64

Drawn	MS
Designed	MS
Approved	RPEQ
Date	

Scale (A1 size)	1:100
Drawing is not to be used for construction unless approved.	



TENDER ISSUE ONLY

51 Sheridan Street
Cairns Qld 4870
T (07) 4281 6897
E admin@arindustries.com.au
W www.arindustries.com.au
ABN: 49 641 461 298

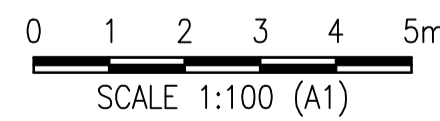
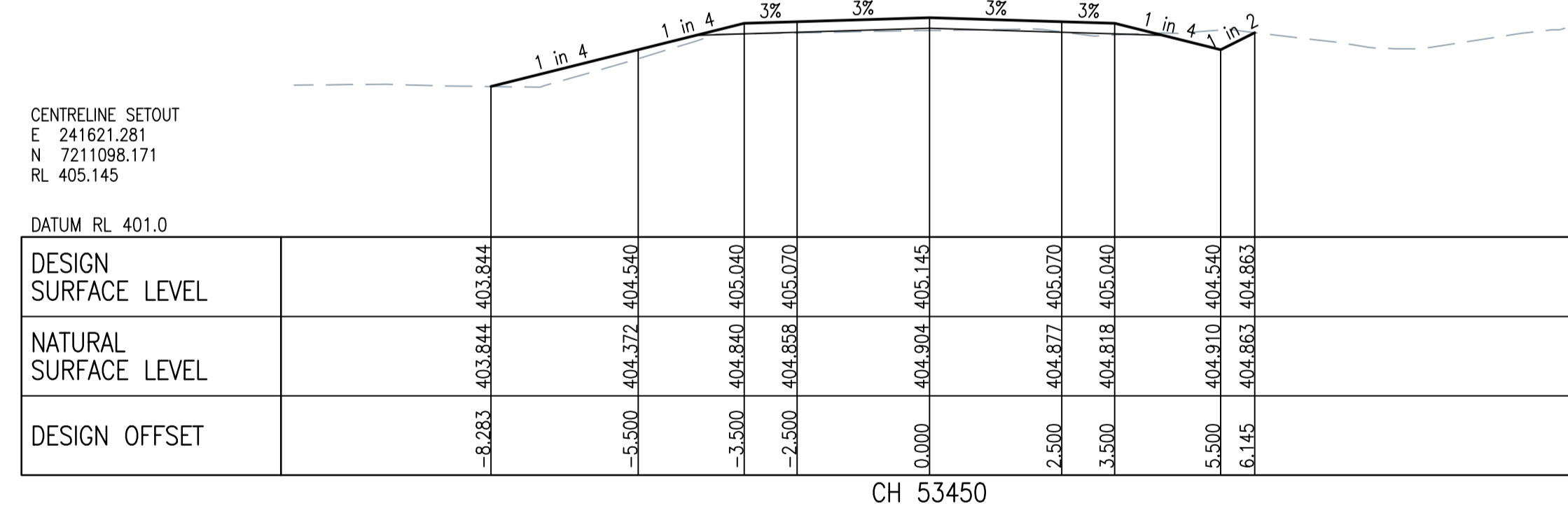
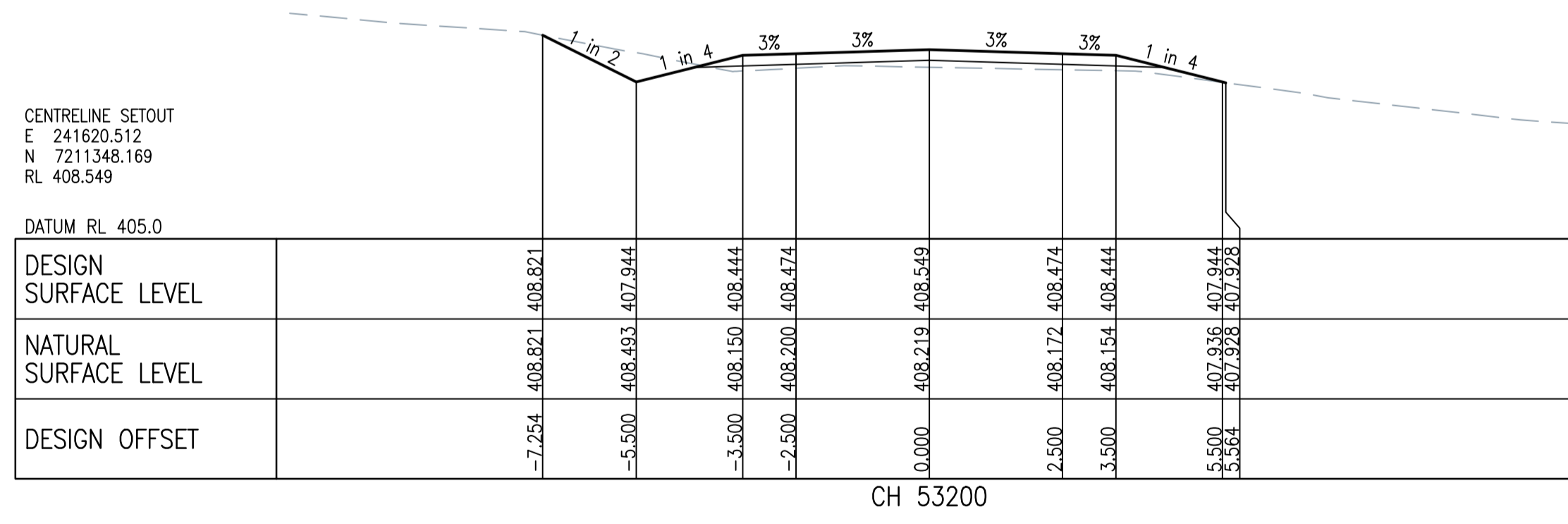
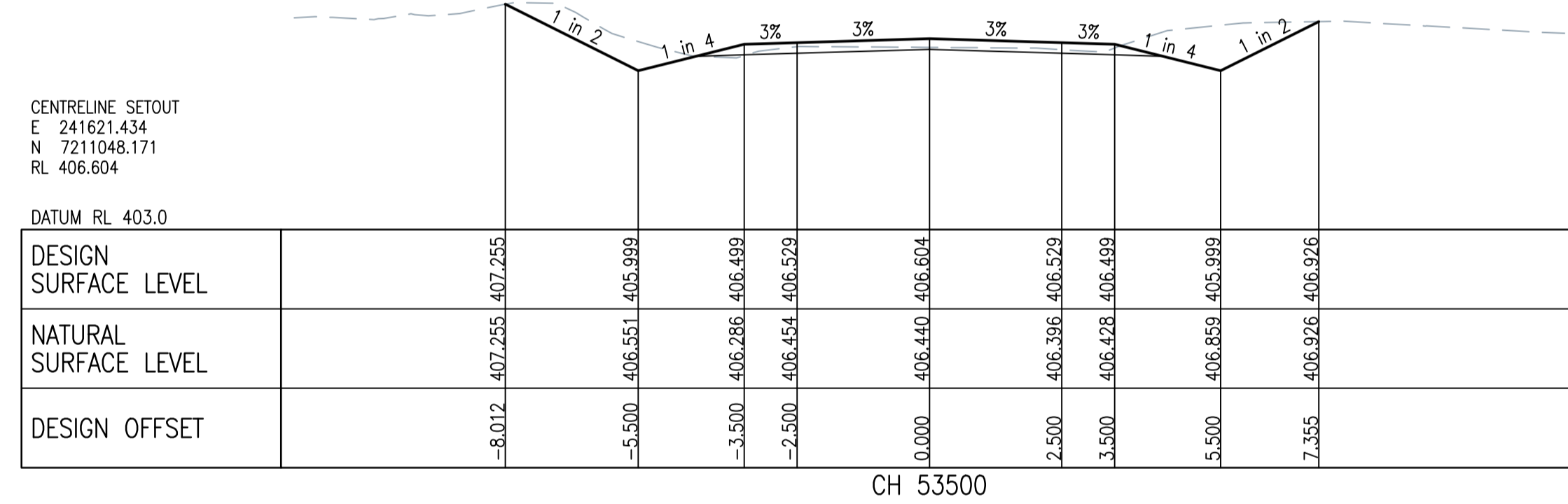
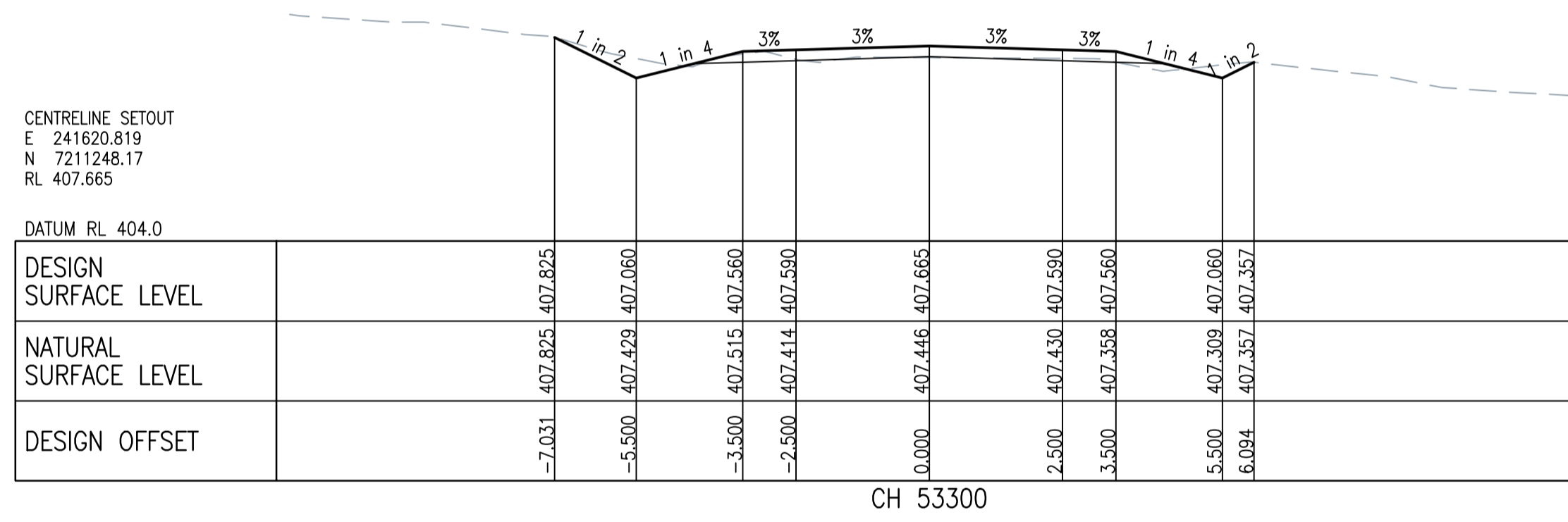
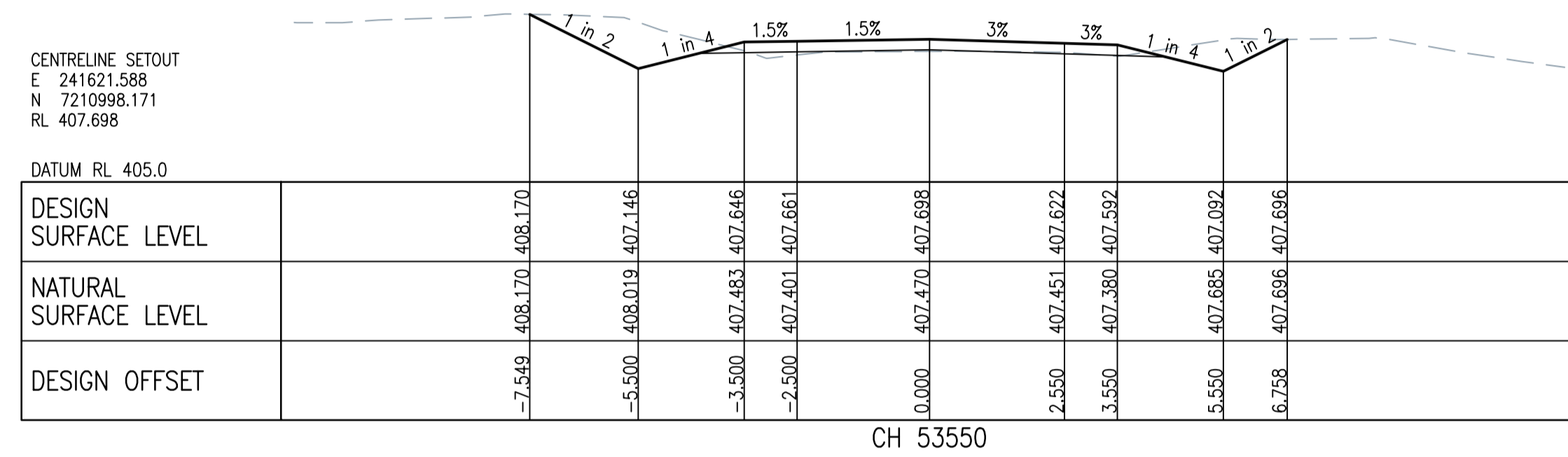
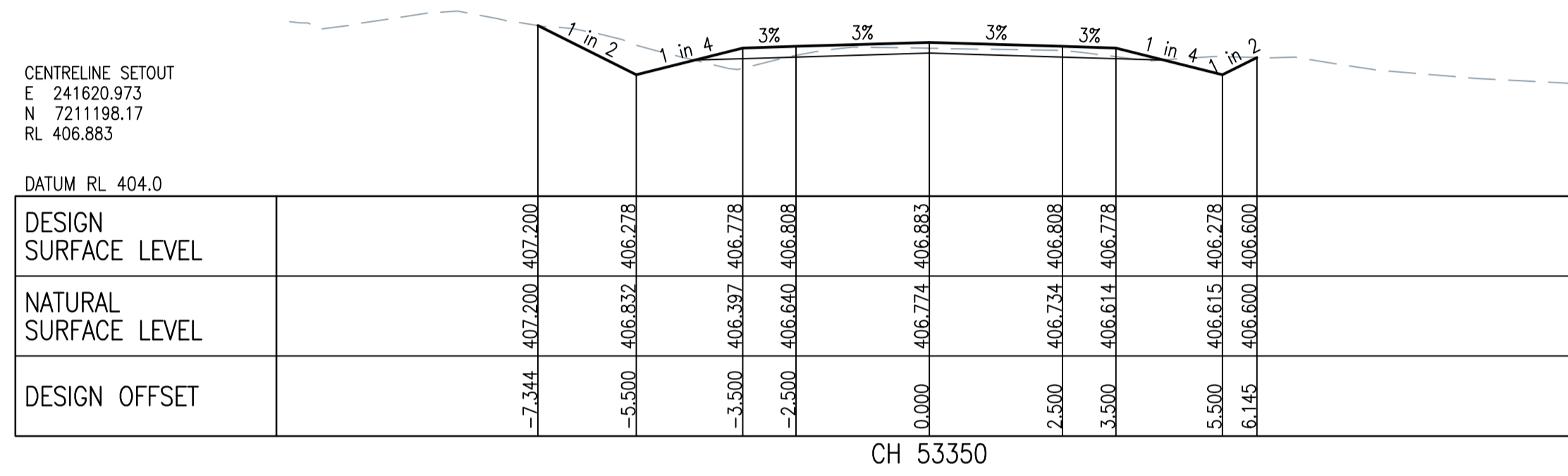
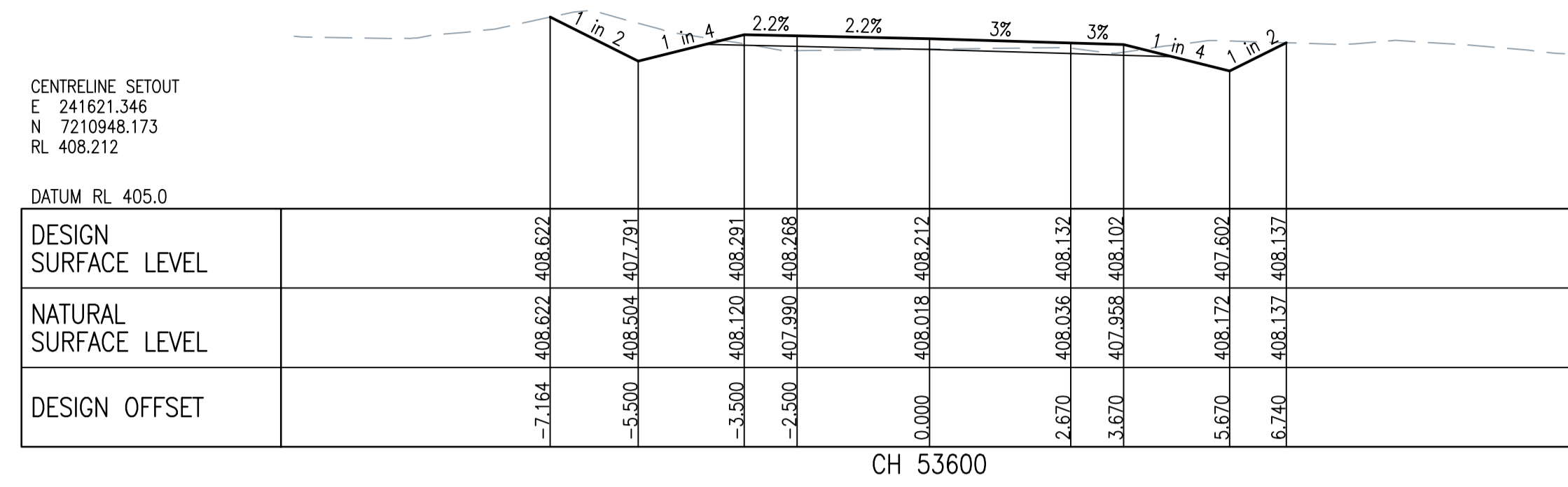
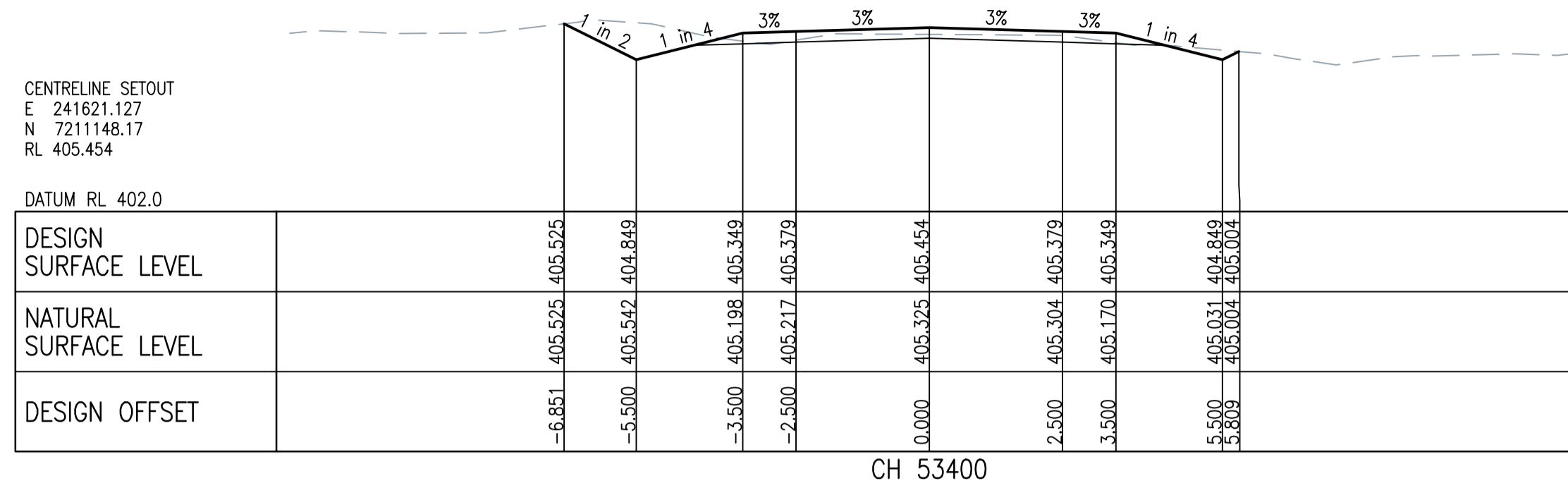

TENDER ISSUE ONLY

No.	Description	Reviewed	Approved	Date
1	TENDER ISSUE	-	-	23/08/2024



Client: BANANA SHIRE COUNCIL
Project: DEFENCE ROAD UPGRADE - CH 36,172 - CH68,499
Title: ANNOTATED CROSS SECTIONS SHEET 35 OF 64

Drawn: MS	Designed: MS	Approved: RPEQ	Scale (A1 size): 1:100
Drawing Check	Design Check	Date	Drawing is not to be used for construction unless approved.



51 Sheridan Street
Cairns Qld 4870
T (07) 4281 6897
E admin@aroindustries.com.au
W www.aroindustries.com.au
ABN: 49 641 461 298

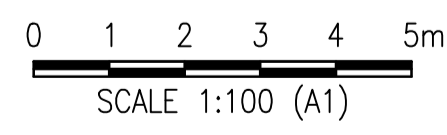
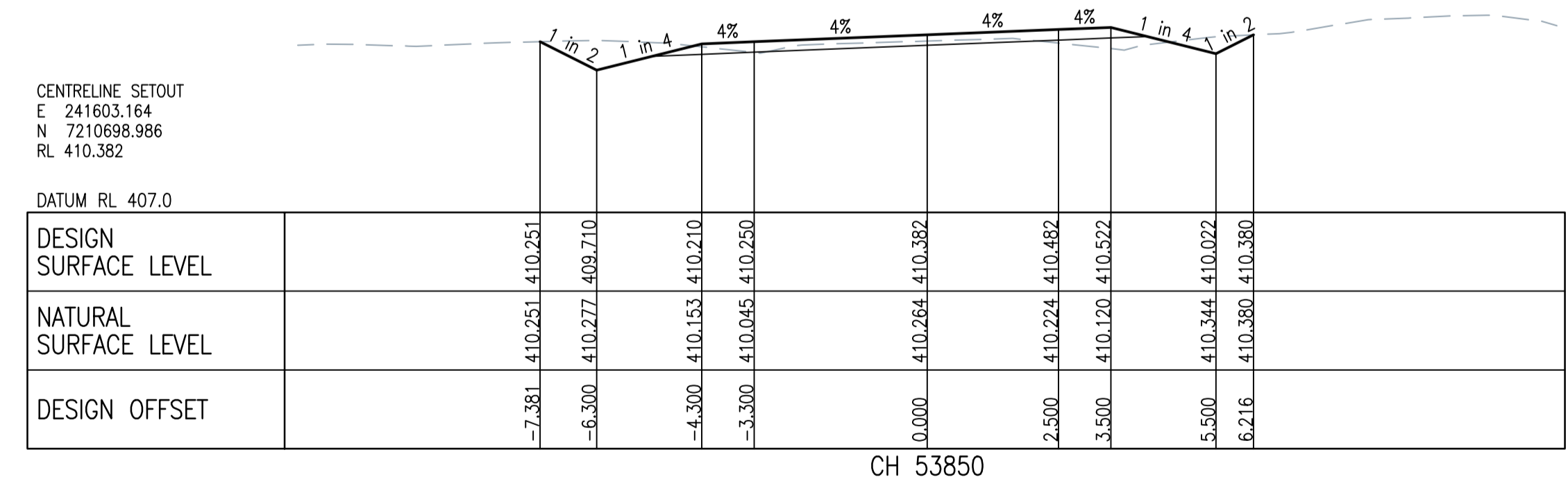
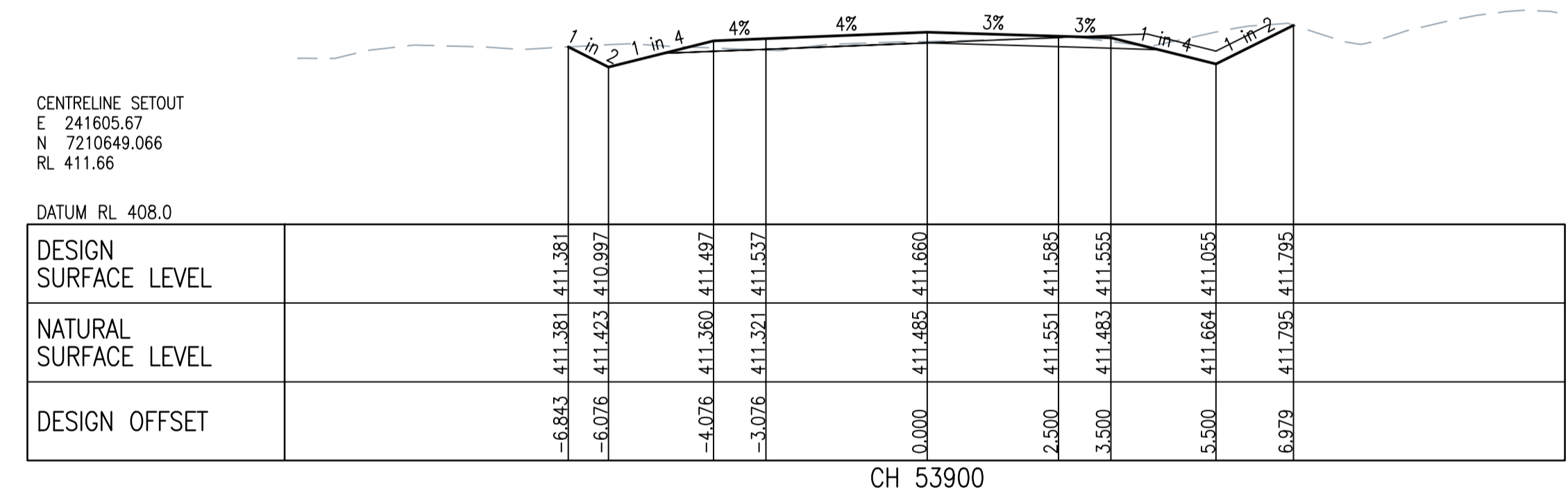
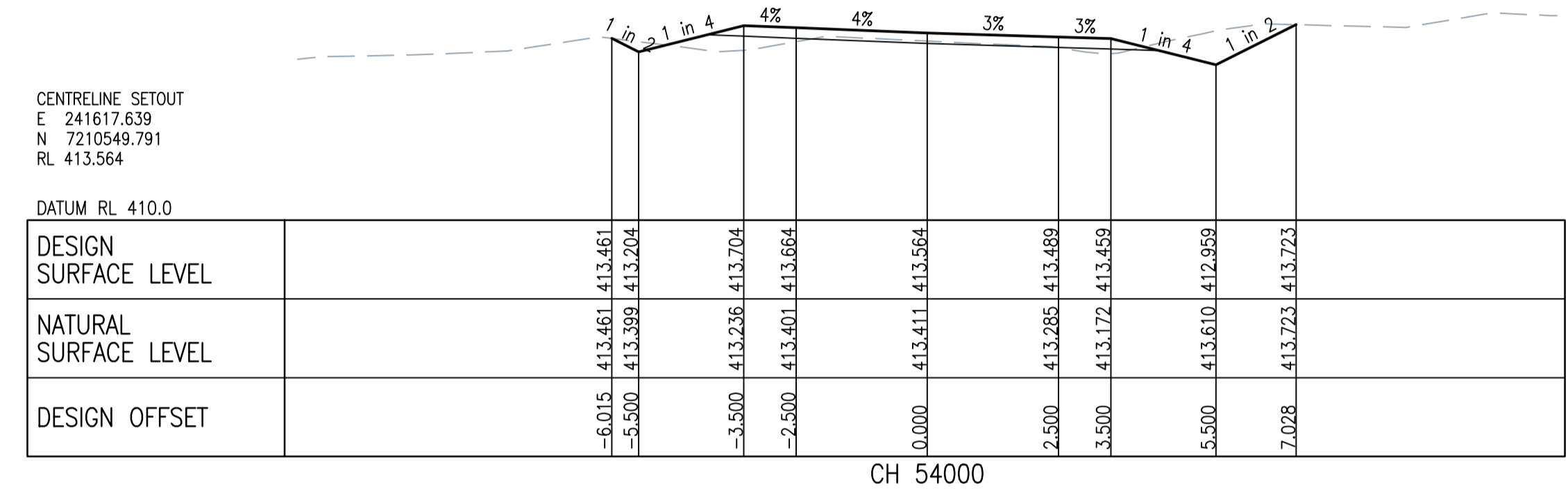
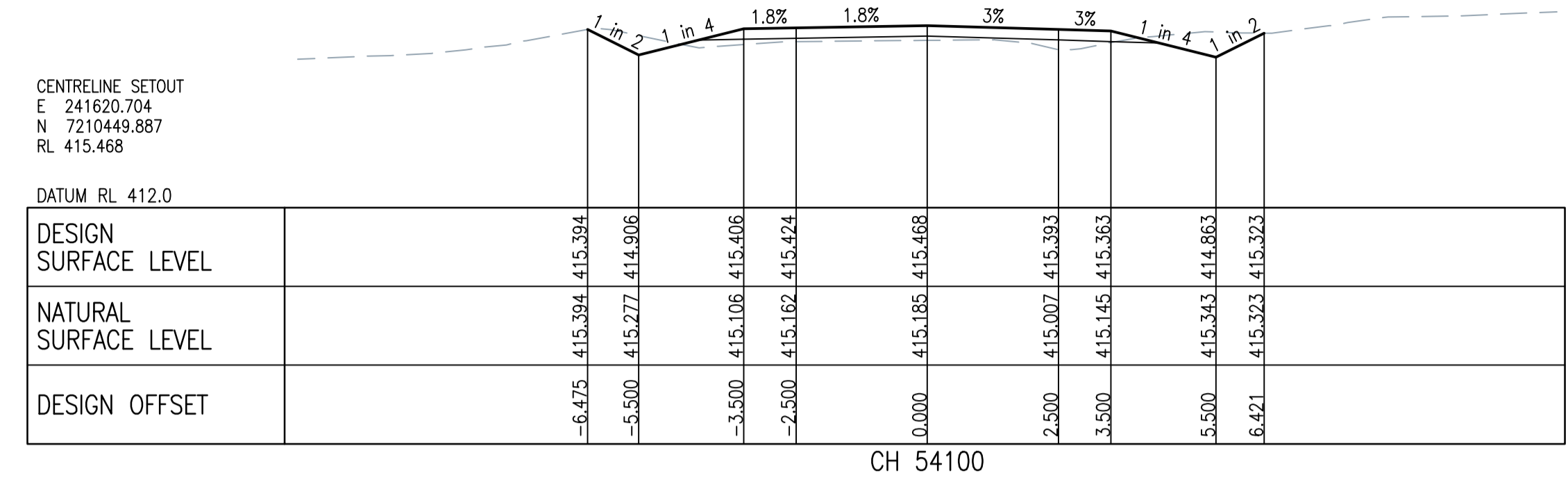
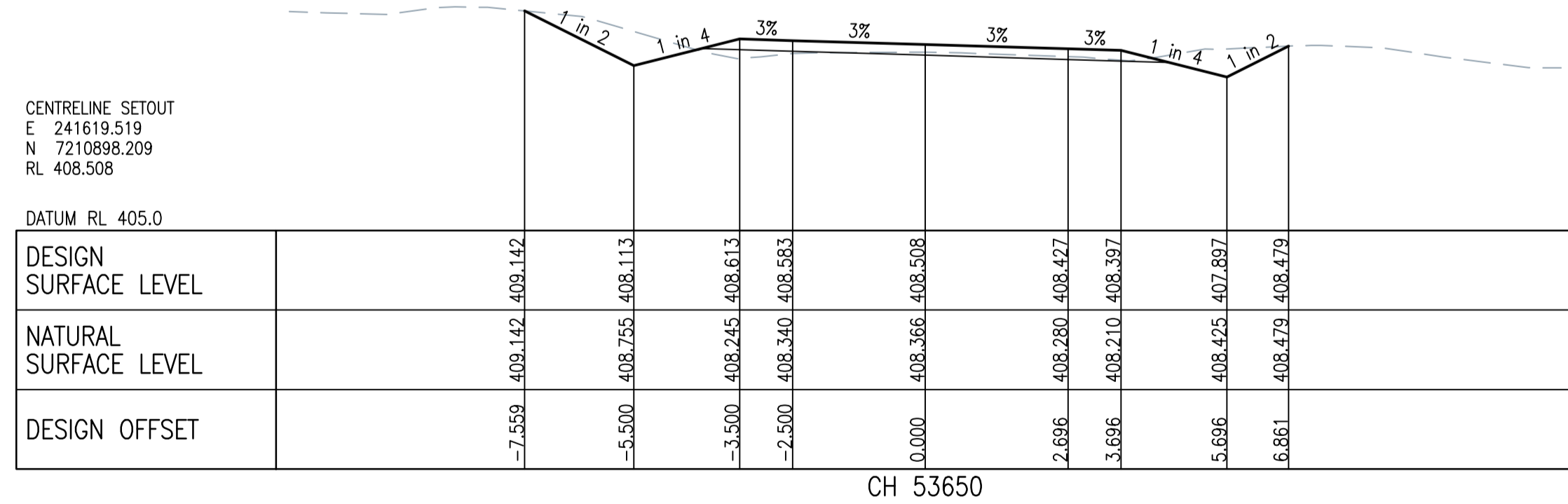
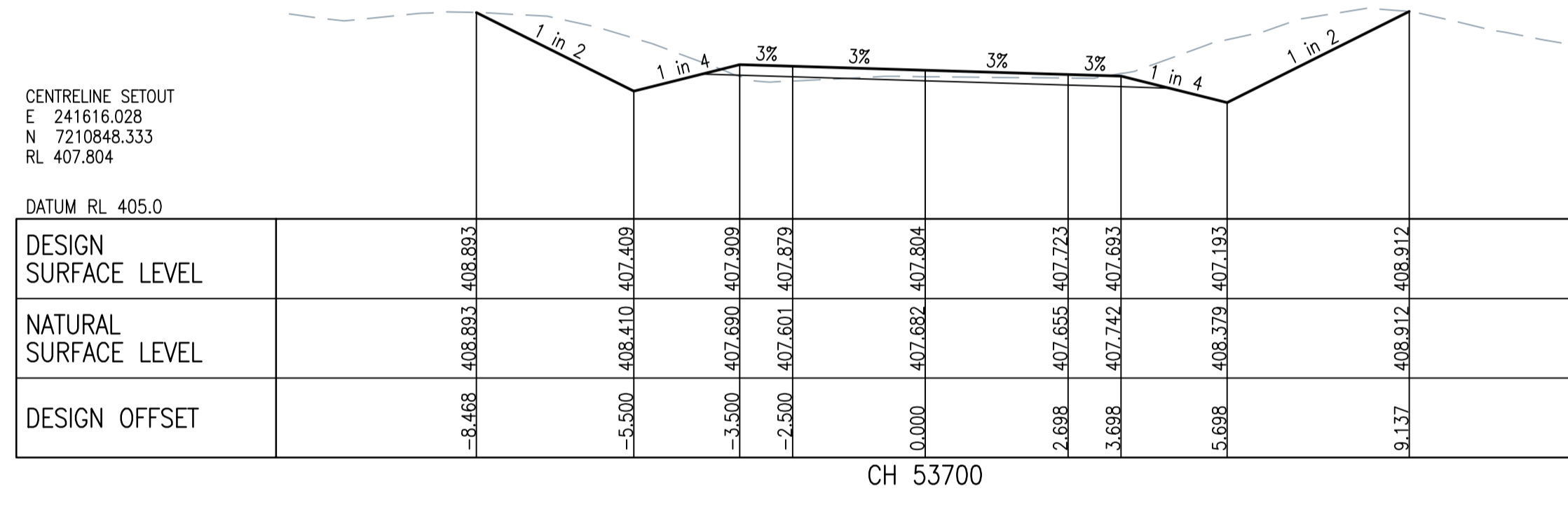
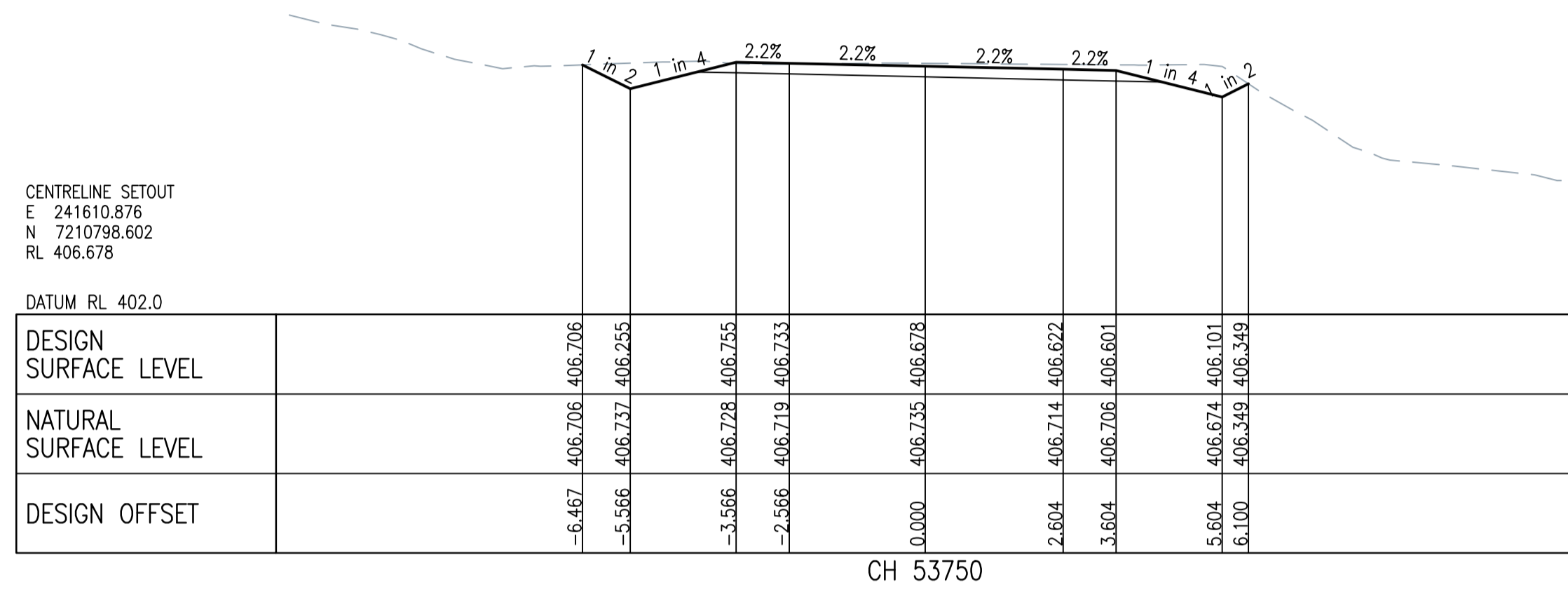
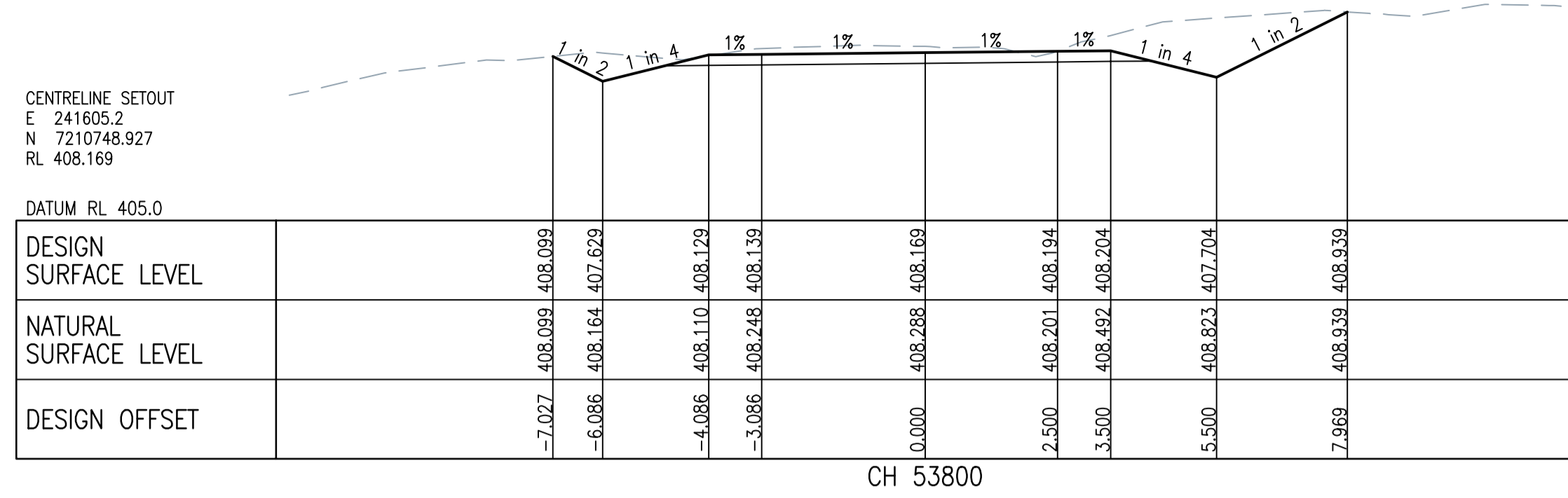

TENDER ISSUE ONLY

No.	Description	Reviewed	Approved	Date
1	TENDER ISSUE	-	-	23/08/2024



Client	BANANA SHIRE COUNCIL
Project	DEFENCE ROAD UPGRADE - CH 36,172 - CH68,499
Title	ANNOTATED CROSS SECTIONS SHEET 36 OF 64
Drawing No.	ARO0400-C85

Drawn	MS	Designed	MS	Approved	
Drawing Check		Design Check		RPEQ	Date

Scale (A1 size)
1:100

Drawing is not to be used for construction unless approved.

51 Sheridan Street
Cairns Qld 4870
T (07) 4281 6897
E admin@arindustries.com.au
W www.arindustries.com.au
ABN: 49 641 461 298

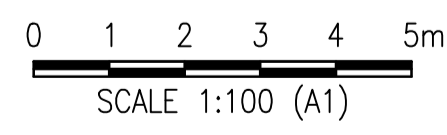
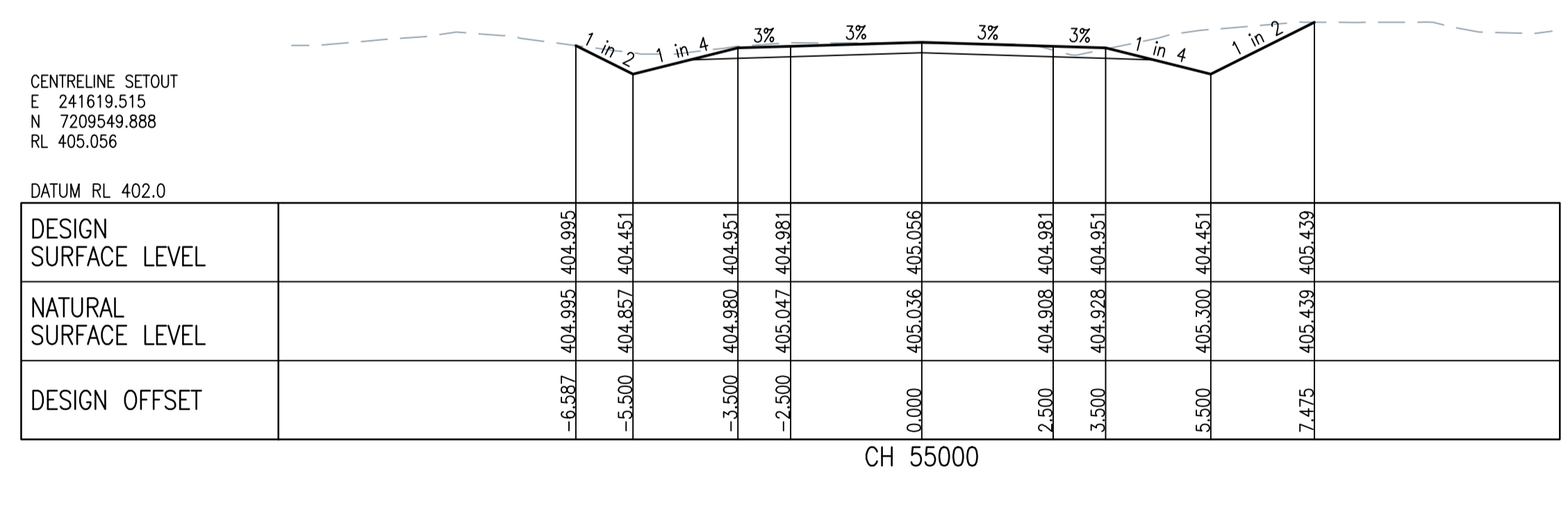
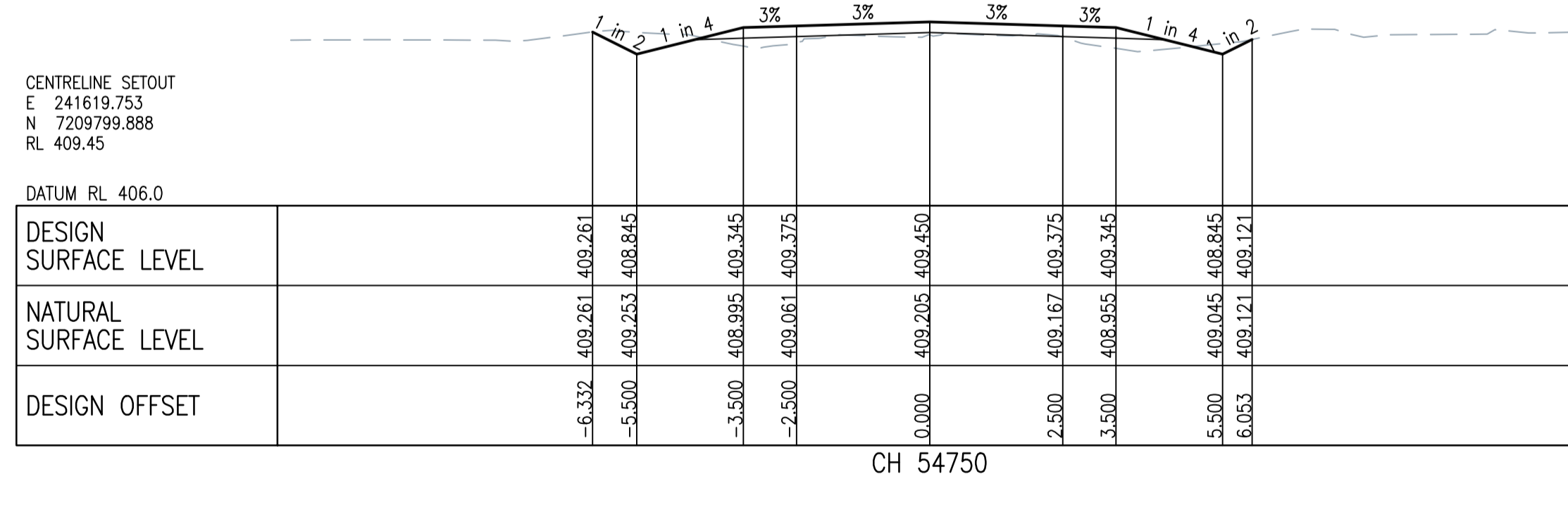
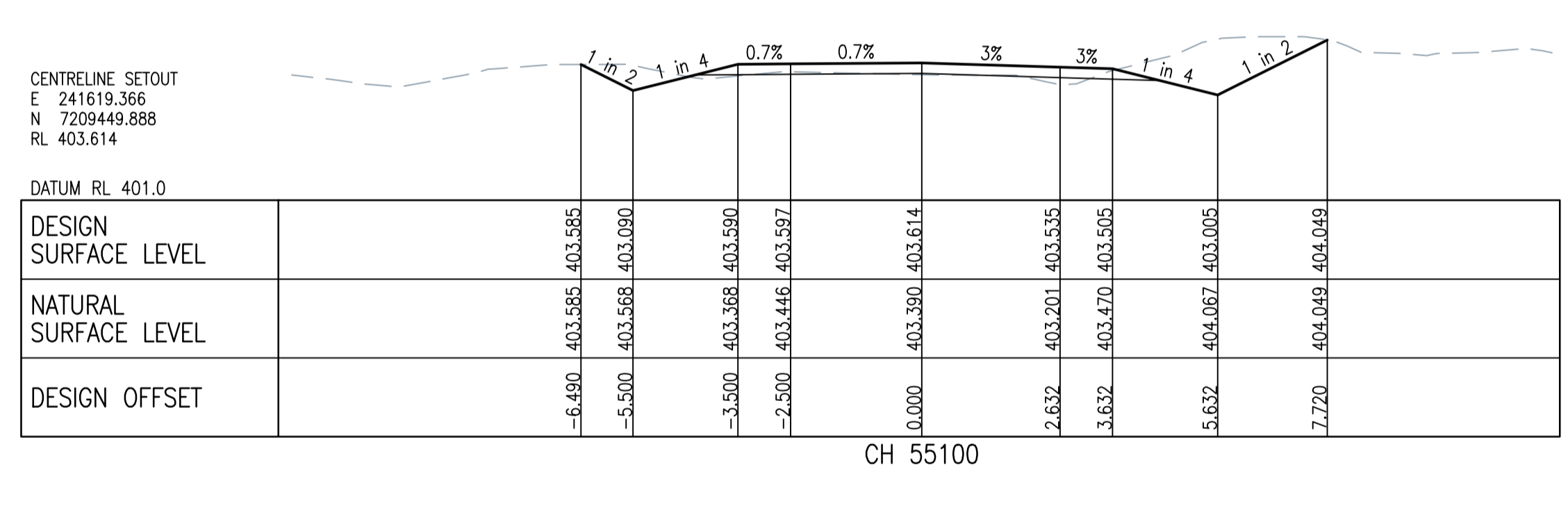
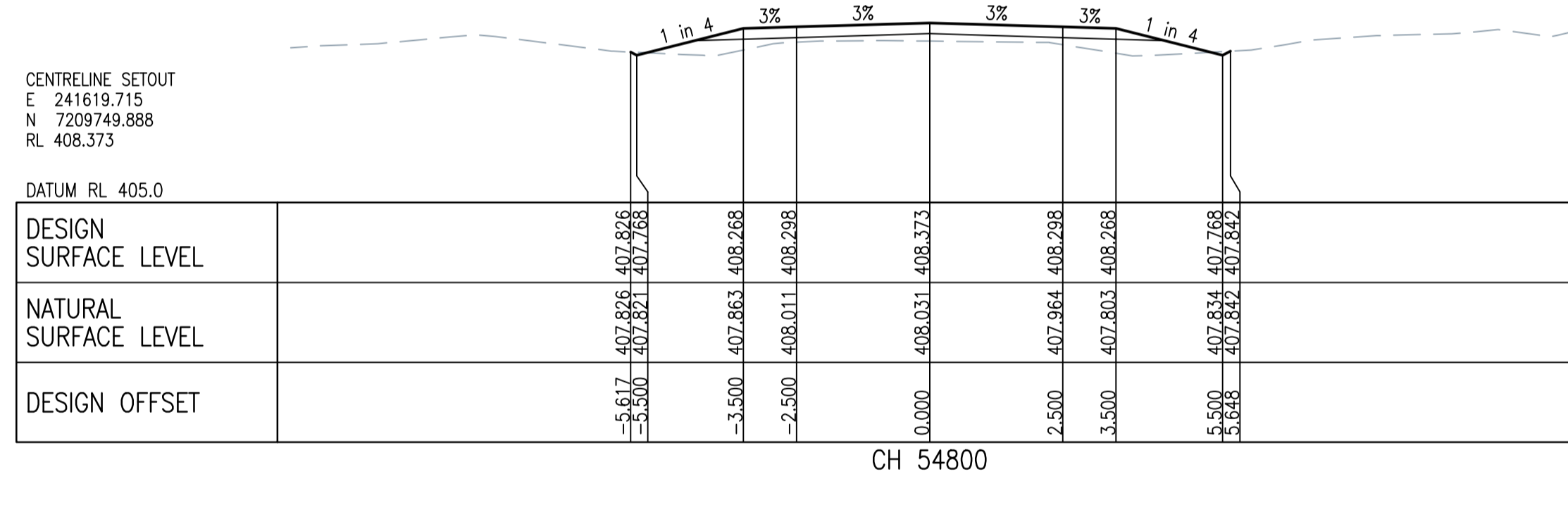
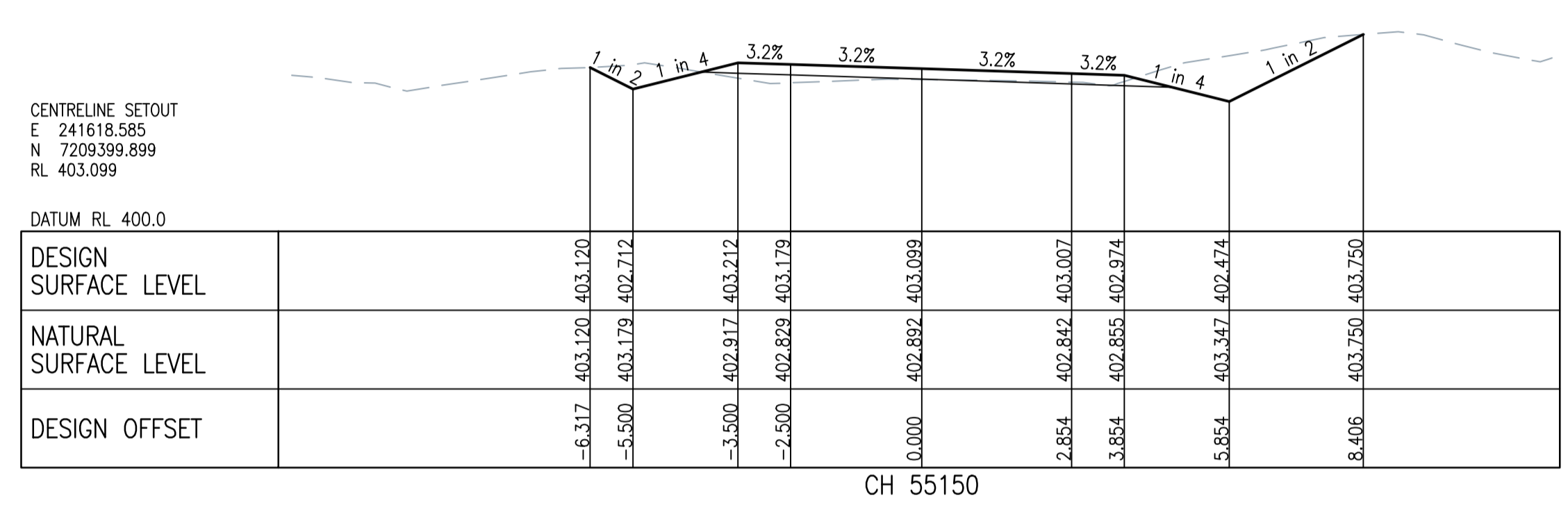
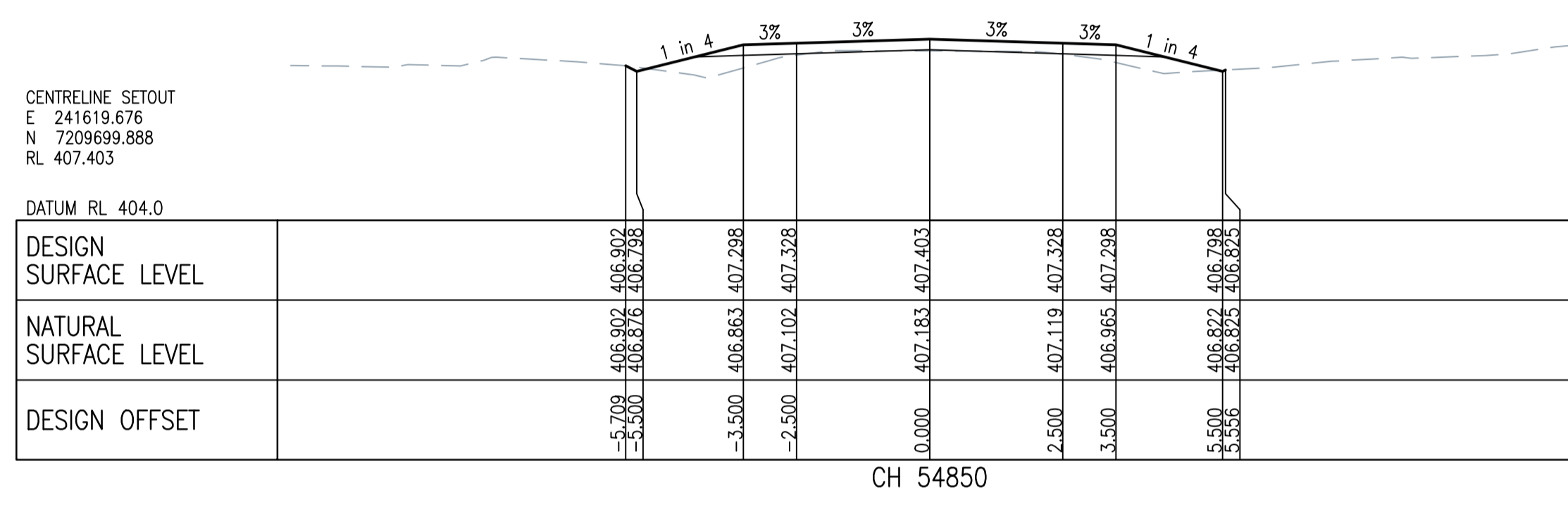
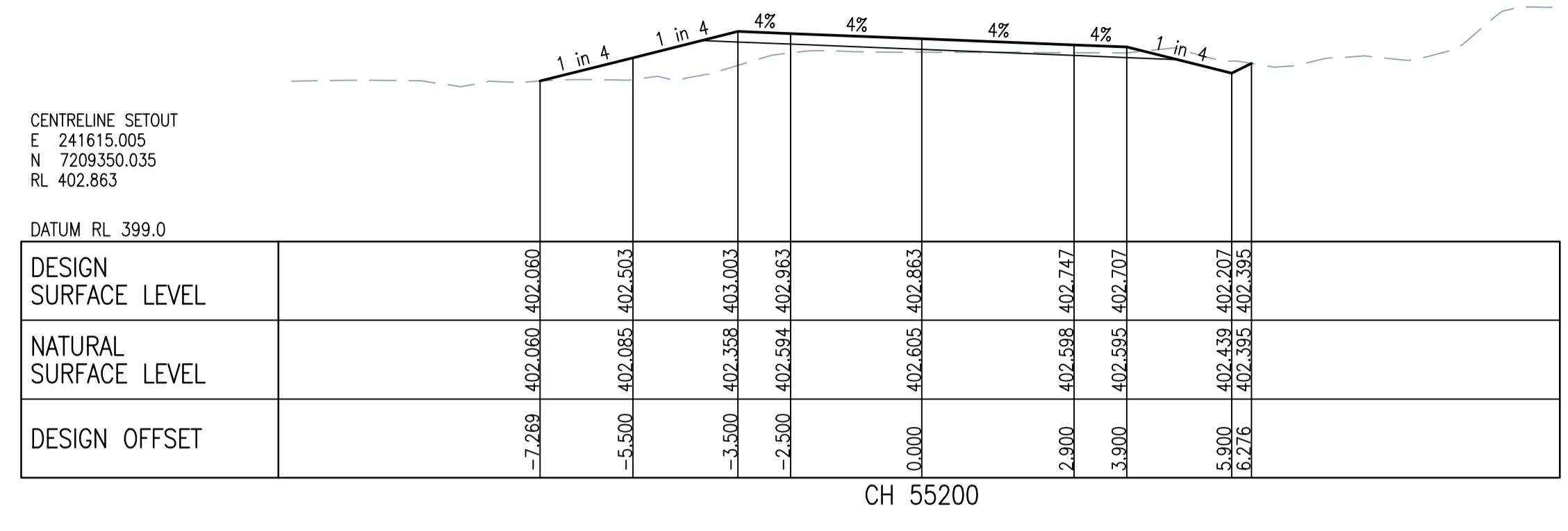
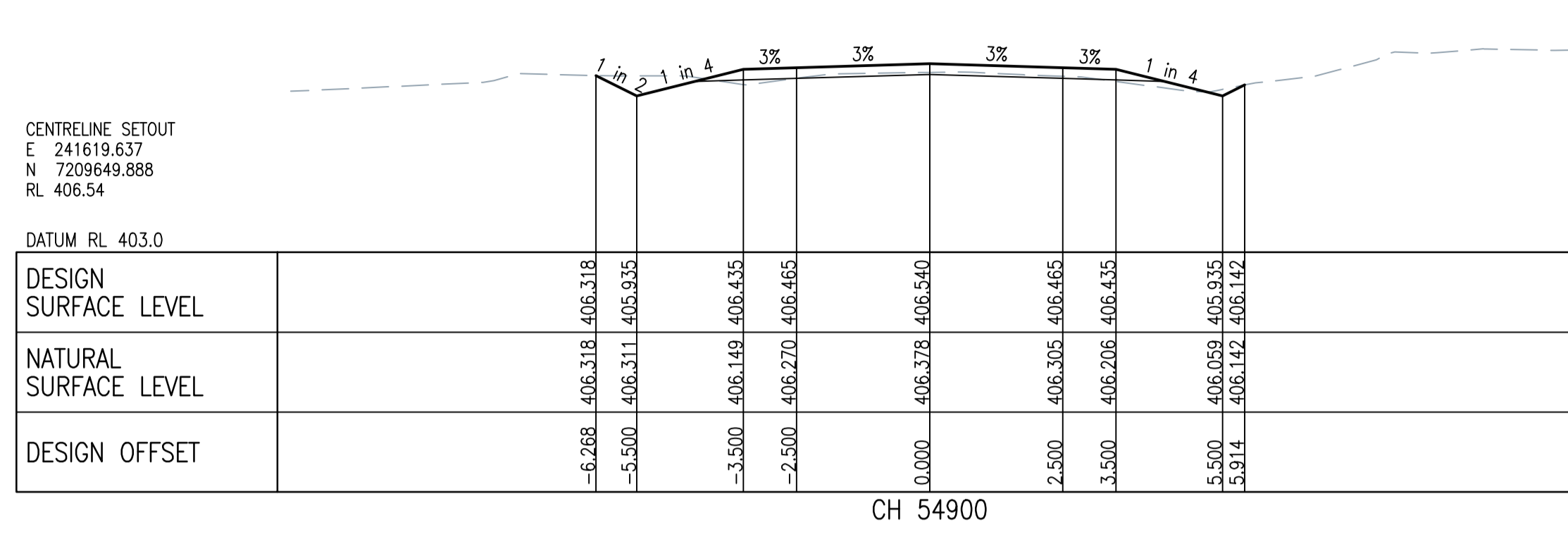

TENDER ISSUE ONLY

No.	Description	Reviewed	Approved	Date
1	TENDER ISSUE			23/08/2024



Client	BANANA SHIRE COUNCIL
Project	DEFENCE ROAD UPGRADE - CH 36,172 - CH68,499
Title	ANNOTATED CROSS SECTIONS SHEET 38 OF 64
Drawing No.	ARO0400-C87

Drawn	MS	Designed	MS	Approved	
Drawing Check		Design Check		RPEQ	Date

Scale (A1 size)
1:100

Drawing is not to be used for construction unless approved.

51 Sheridan Street
Cairns Qld 4870
T (07) 4281 6897
E admin@arindustries.com.au
W www.arindustries.com.au
ABN: 49 641 461 298

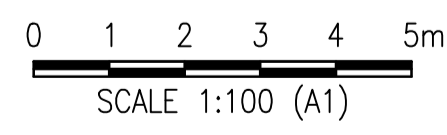
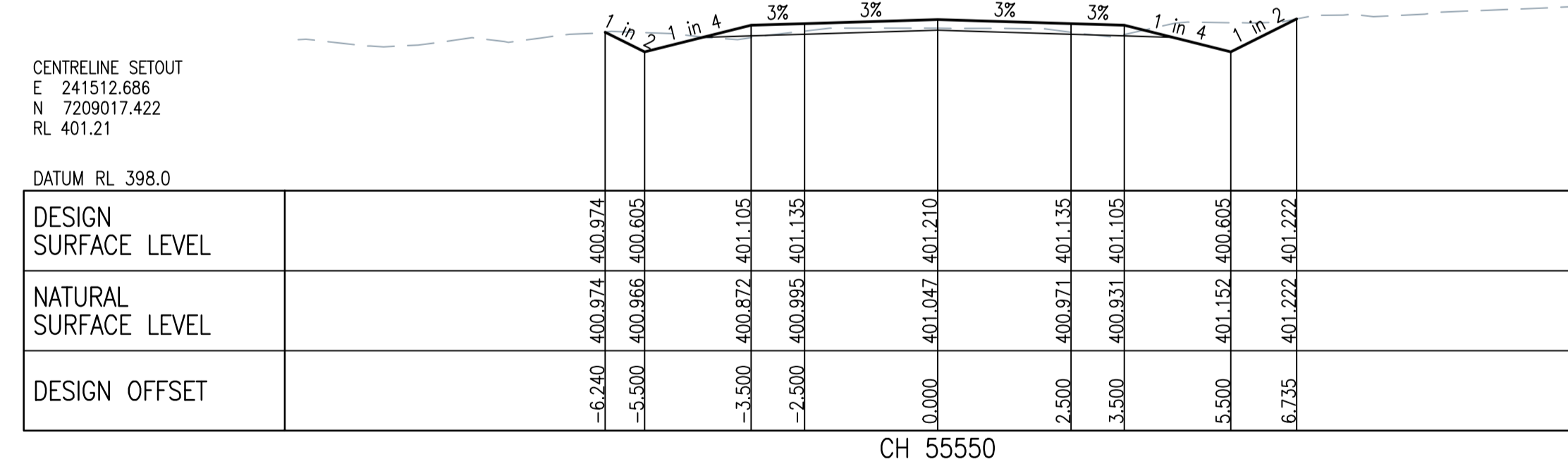
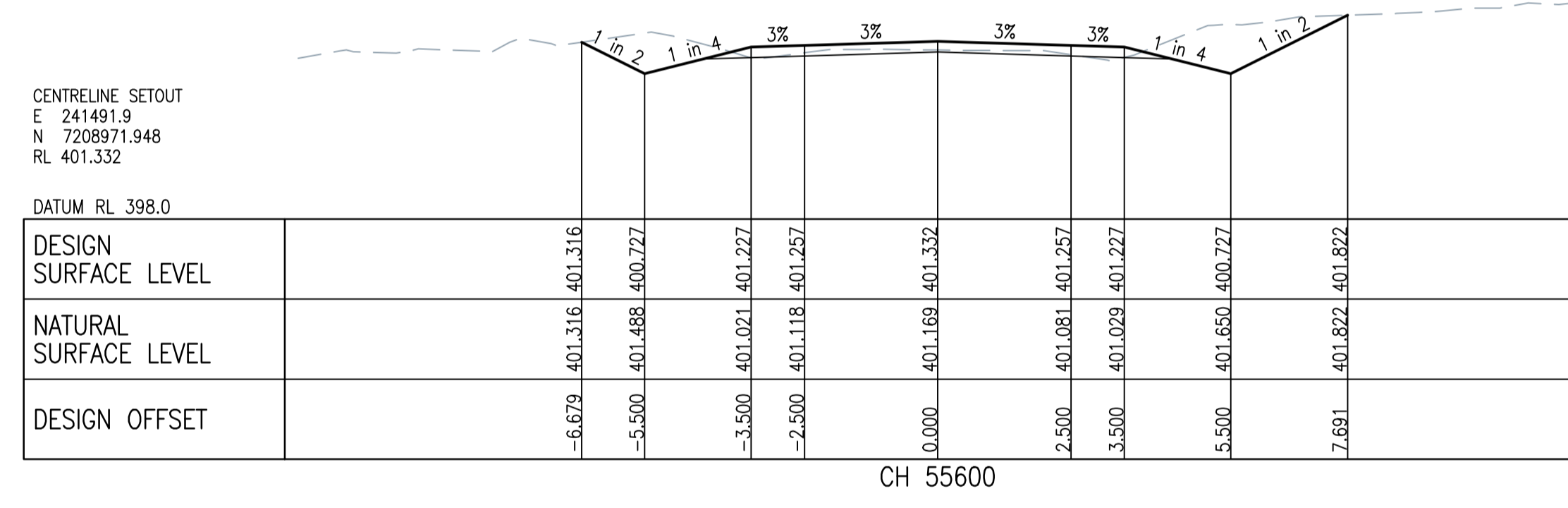
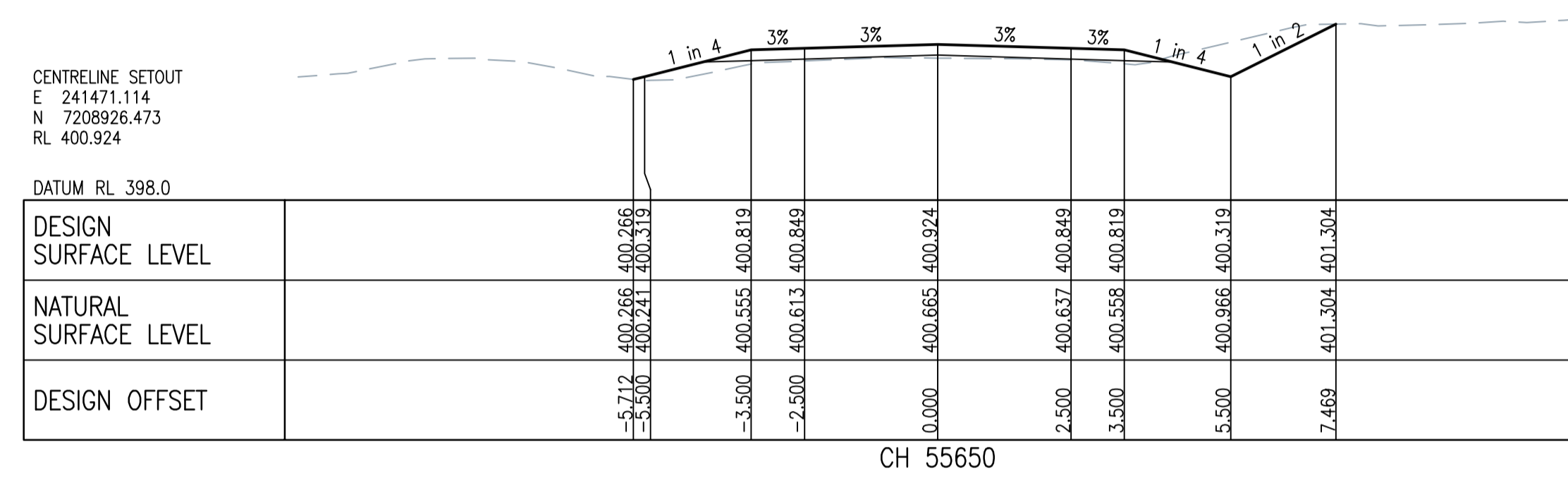
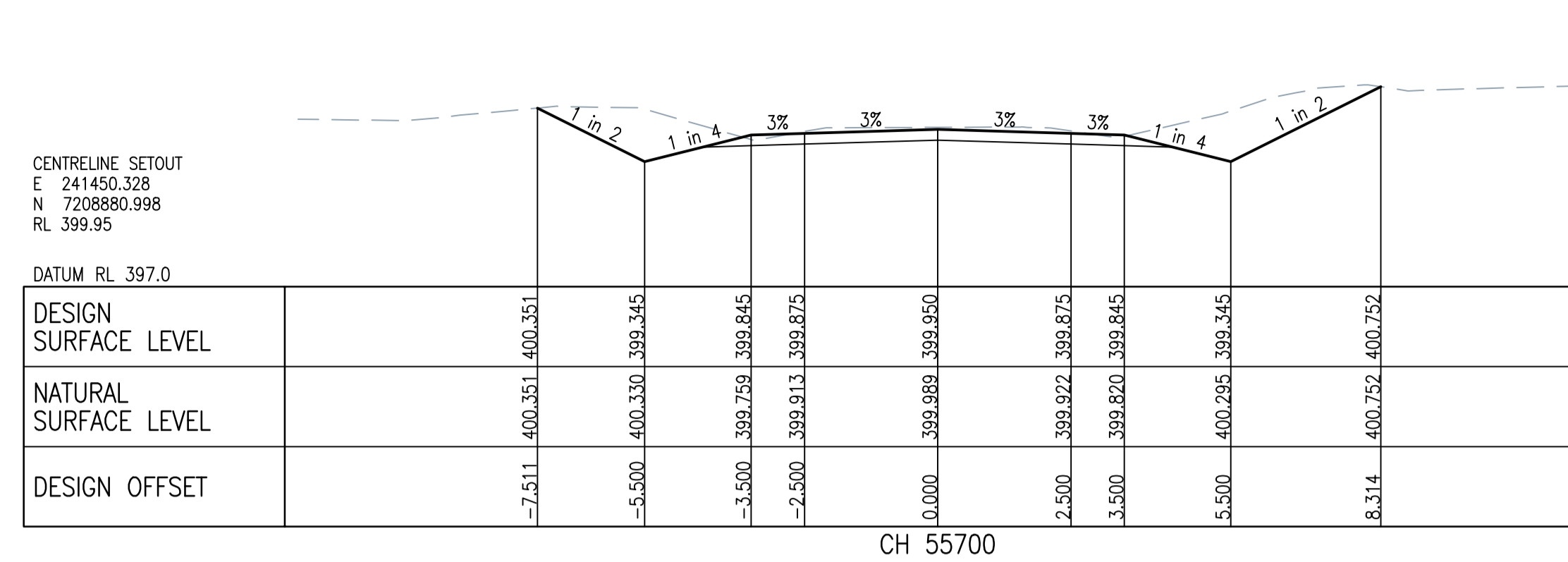
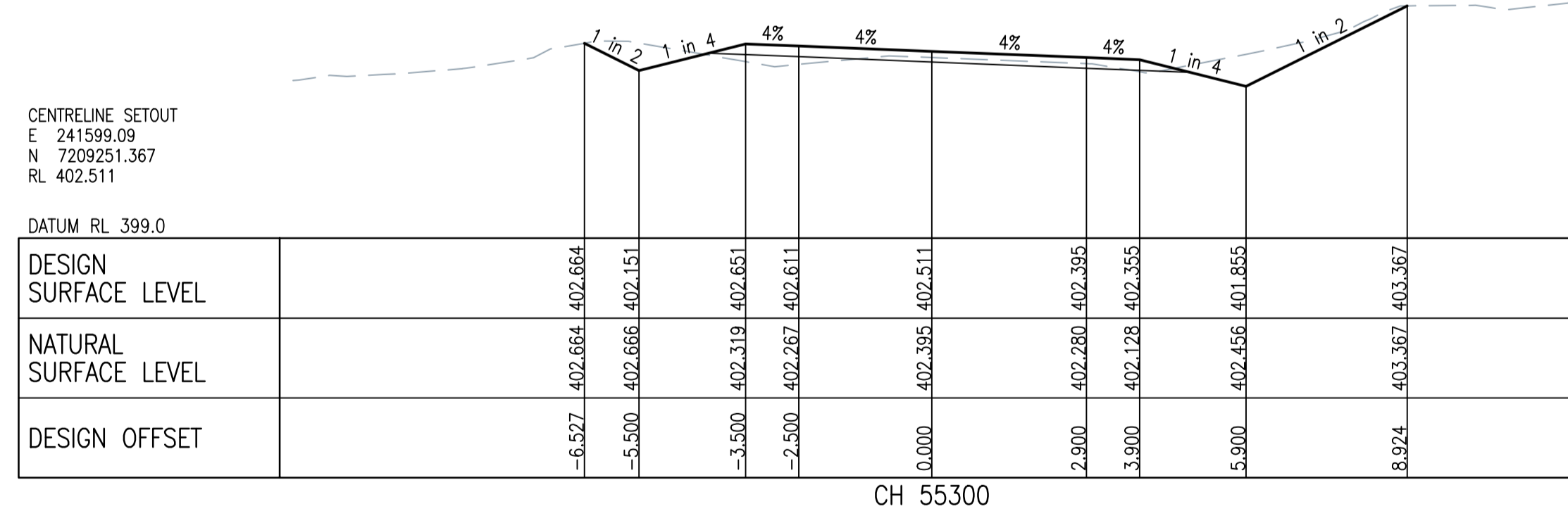
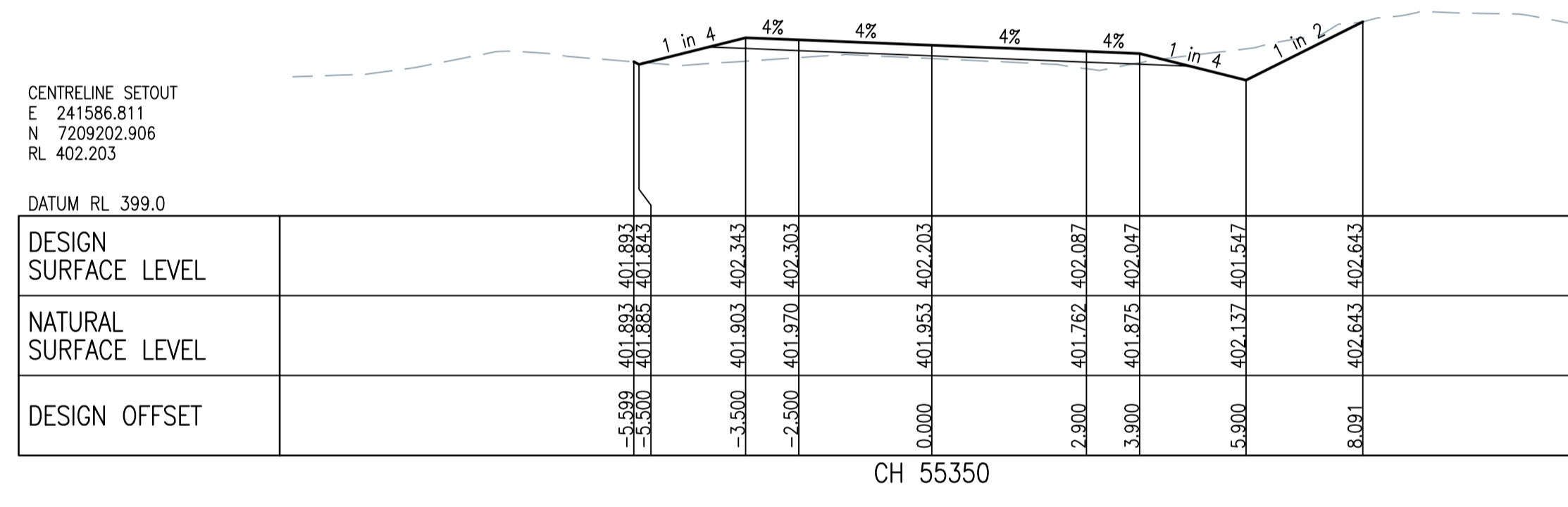
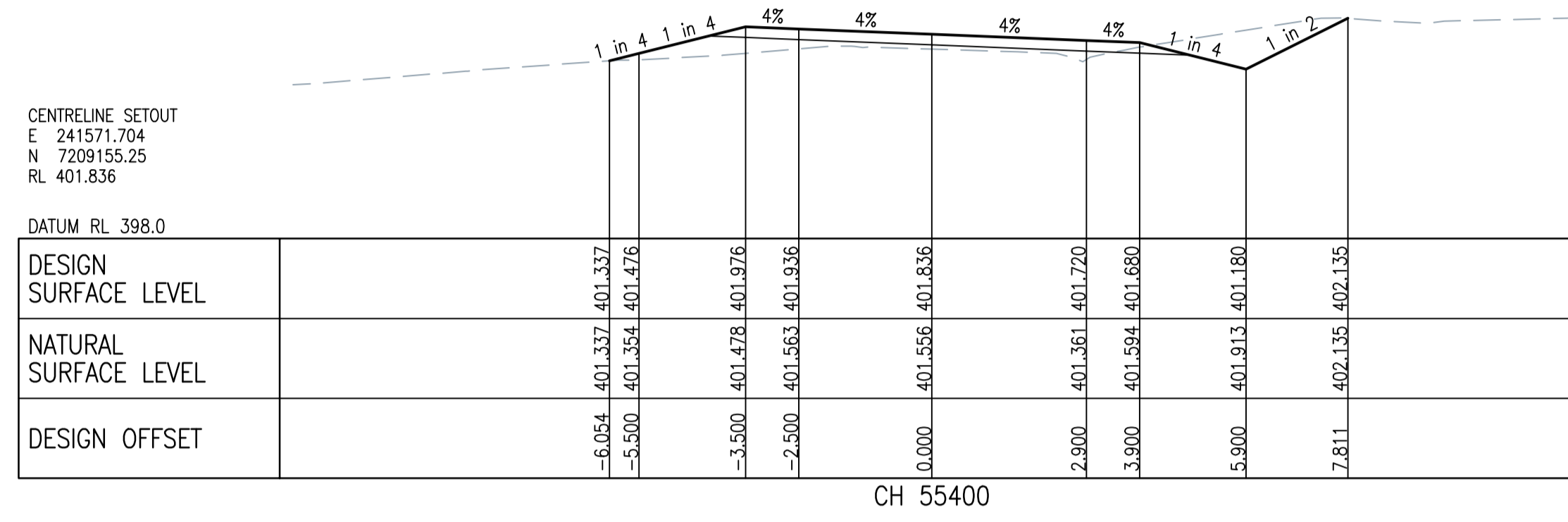
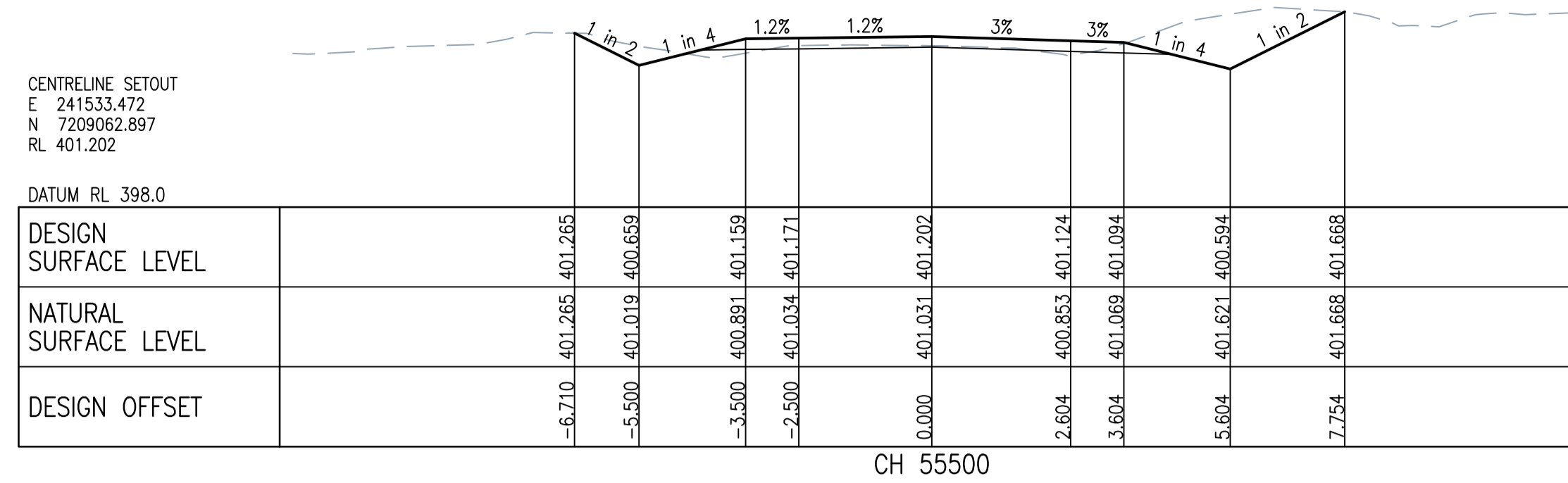

No.	Description	Reviewed	Approved	Date
1	TENDER ISSUE			23/08/2024



Client: BANANA SHIRE COUNCIL
Project: DEFENCE ROAD UPGRADE - CH 36,172 - CH68,499
Title: ANNOTATED CROSS SECTIONS SHEET 39 OF 64
Drawing No. ARO0400-C88

Drawn	MS	Designed	MS	Approved	RPEQ	Date
Drawing Check		Design Check				

Scale (A1 size): 1:100

Drawing is not to be used for construction unless approved.

51 Sheridan Street
Cairns Qld 4870
T (07) 4281 6897
E admin@arindustries.com.au
W www.arindustries.com.au
ABN: 49 641 461 298

TENDER ISSUE ONLY

CENTRELINE SETOUT
E 240935.249
N 7207742.194
RL 382.3

DATUM RL 379.0

DESIGN SURFACE LEVEL									
NATURAL SURFACE LEVEL									
DESIGN OFFSET									

CH 56950

CENTRELINE SETOUT
E 240953.107
N 7207788.678
RL 382.251

DATUM RL 378.0

DESIGN SURFACE LEVEL									
NATURAL SURFACE LEVEL									
DESIGN OFFSET									

CH 56900

CENTRELINE SETOUT
E 240972.725
N 7207834.868
RL 382.023

DATUM RL 378.0

DESIGN SURFACE LEVEL									
NATURAL SURFACE LEVEL									
DESIGN OFFSET									

CH 56850

CENTRELINE SETOUT
E 240993.213
N 7207880.477
RL 382.642

DATUM RL 379.0

DESIGN SURFACE LEVEL									
NATURAL SURFACE LEVEL									
DESIGN OFFSET									

CH 56800

CENTRELINE SETOUT
E 240852.739
N 7207561.029
RL 383.875

DATUM RL 381.0

DESIGN SURFACE LEVEL									
NATURAL SURFACE LEVEL									
DESIGN OFFSET									

CH 57150

CENTRELINE SETOUT
E 240878.704
N 7207603.758
RL 380.129

DATUM RL 377.0

DESIGN SURFACE LEVEL									
NATURAL SURFACE LEVEL									
DESIGN OFFSET									

CH 57100

CENTRELINE SETOUT
E 240901.857
N 7207648.05
RL 376.423

DATUM RL 372.0

DESIGN SURFACE LEVEL									
NATURAL SURFACE LEVEL									
DESIGN OFFSET									

CH 57050

CENTRELINE SETOUT
E 240920.473
N 7207694.434
RL 380.107

DATUM RL 377.0

DESIGN SURFACE LEVEL									
NATURAL SURFACE LEVEL									
DESIGN OFFSET									

CH 57000

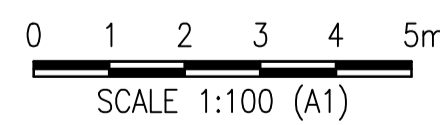

TENDER ISSUE ONLY

No.	Description	Reviewed	Approved	Date
1	TENDER ISSUE			23/08/2024



Client	BANANA SHIRE COUNCIL
Project	DEFENCE ROAD UPGRADE - CH 36,172 - CH68,499
Title	ANNOTATED CROSS SECTIONS SHEET 42 OF 64
Drawing No.	ARO0400-C91

Drawn	MS	Designed	MS	Approved	
Drawing Check		Design Check		RPEQ	Date

Scale (A1 size)
1:100

Drawing is not to be used for construction unless approved.

51 Sheridan Street
Cairns Qld 4870
T (07) 4281 6897
E admin@arindustries.com.au
W www.arindustries.com.au
ABN: 49 641 461 298

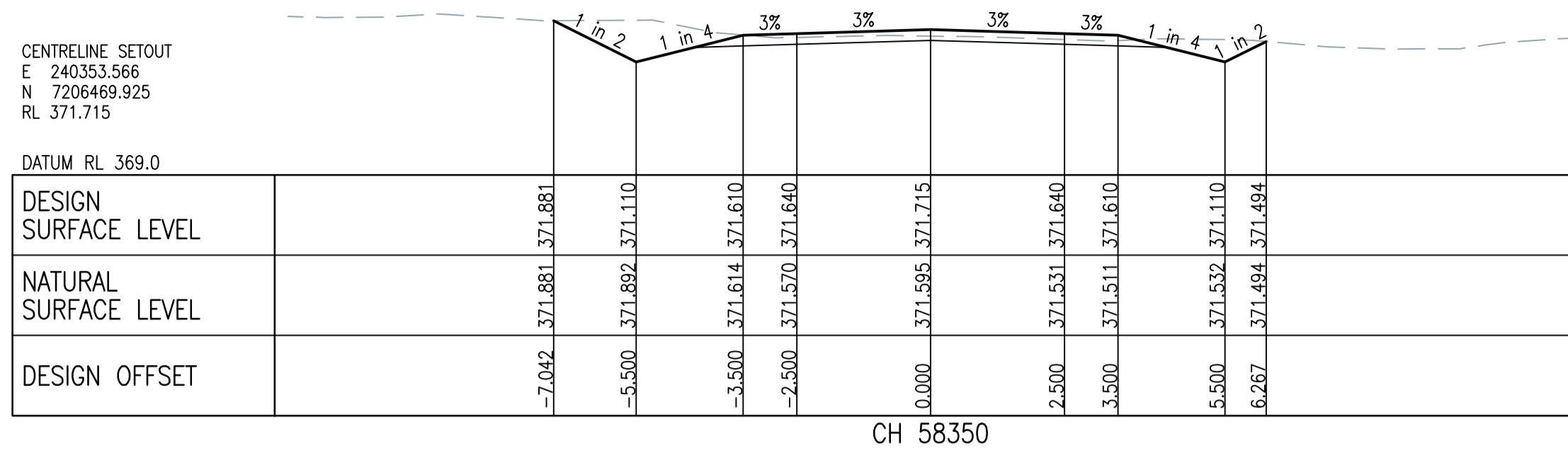

CH 58350

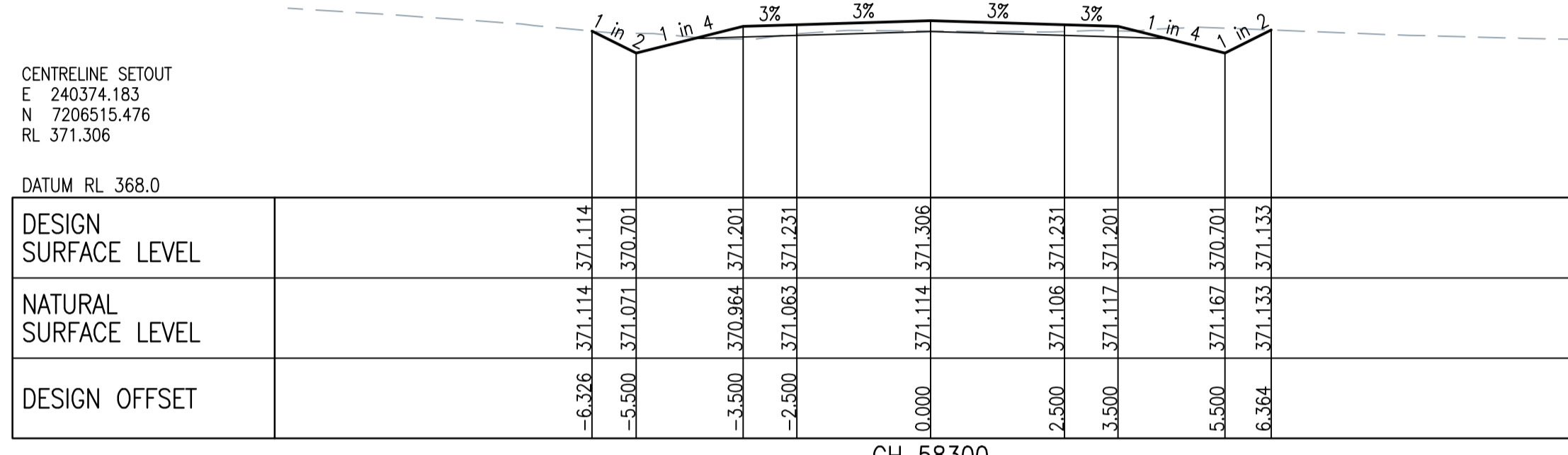

CH 58300

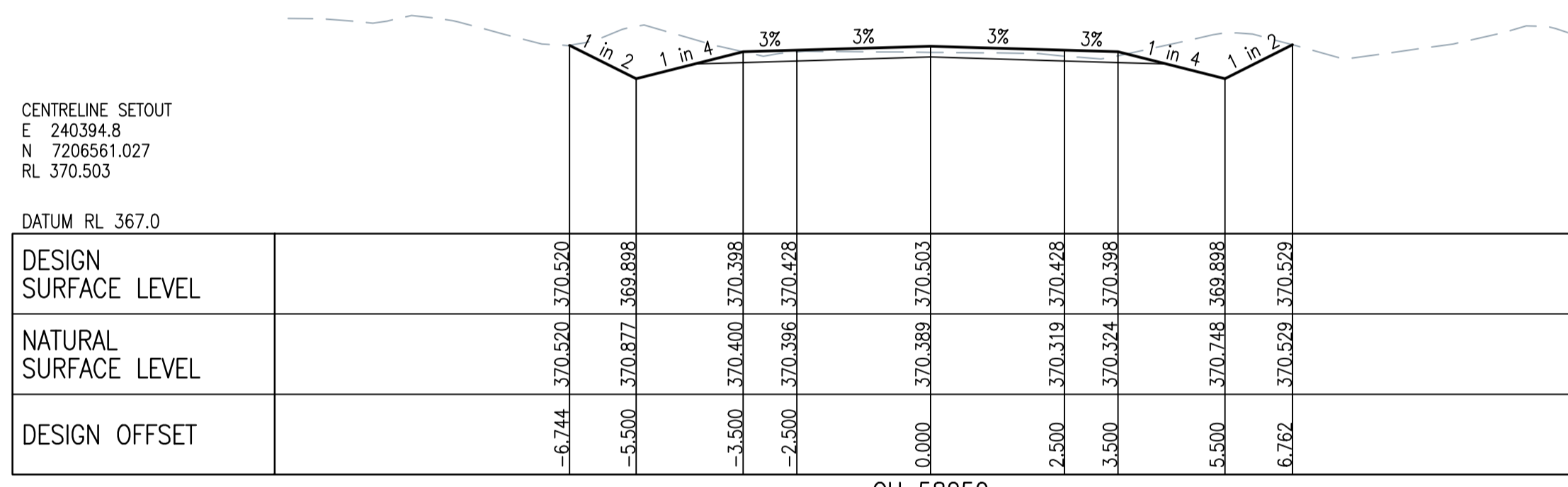

CH 58250

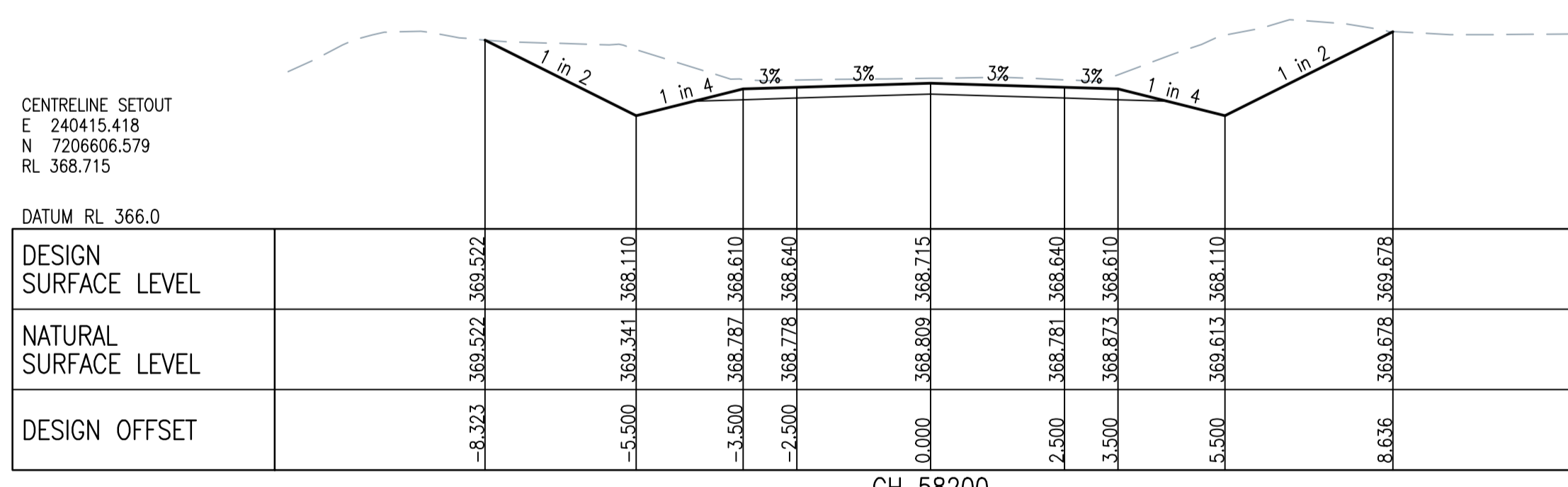

CH 58200

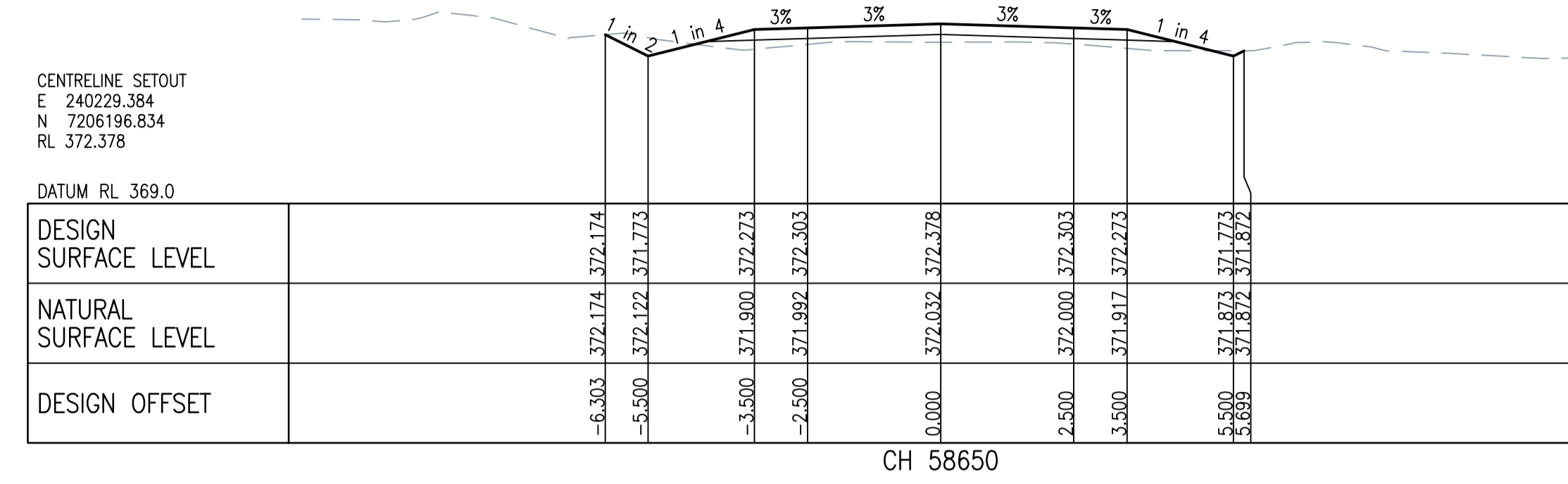

CH 58650

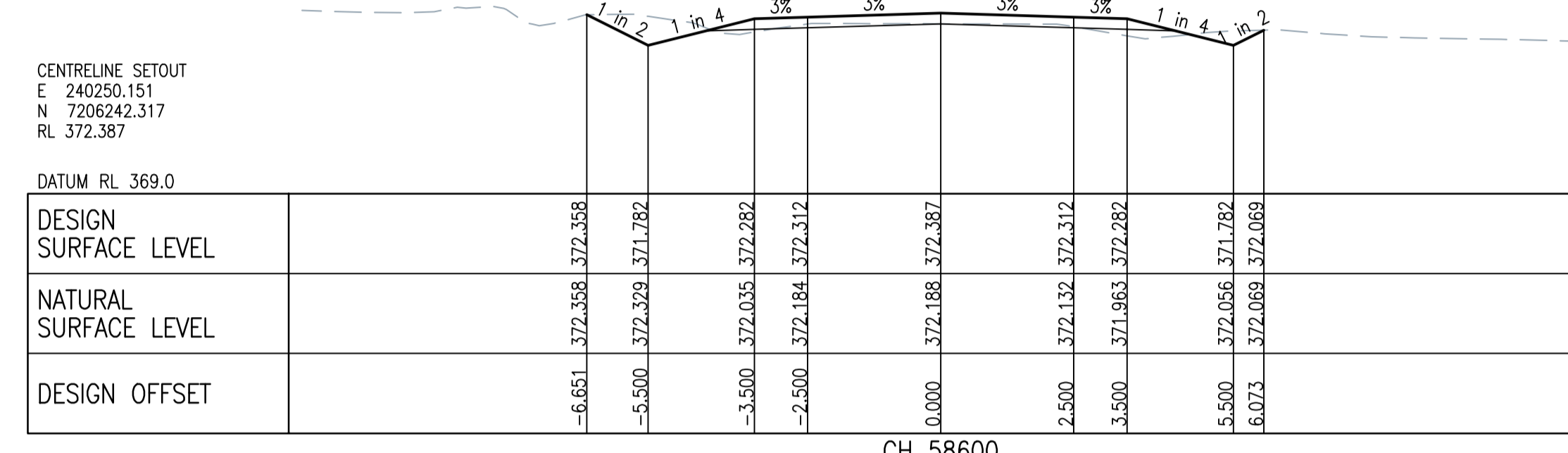

CH 58600

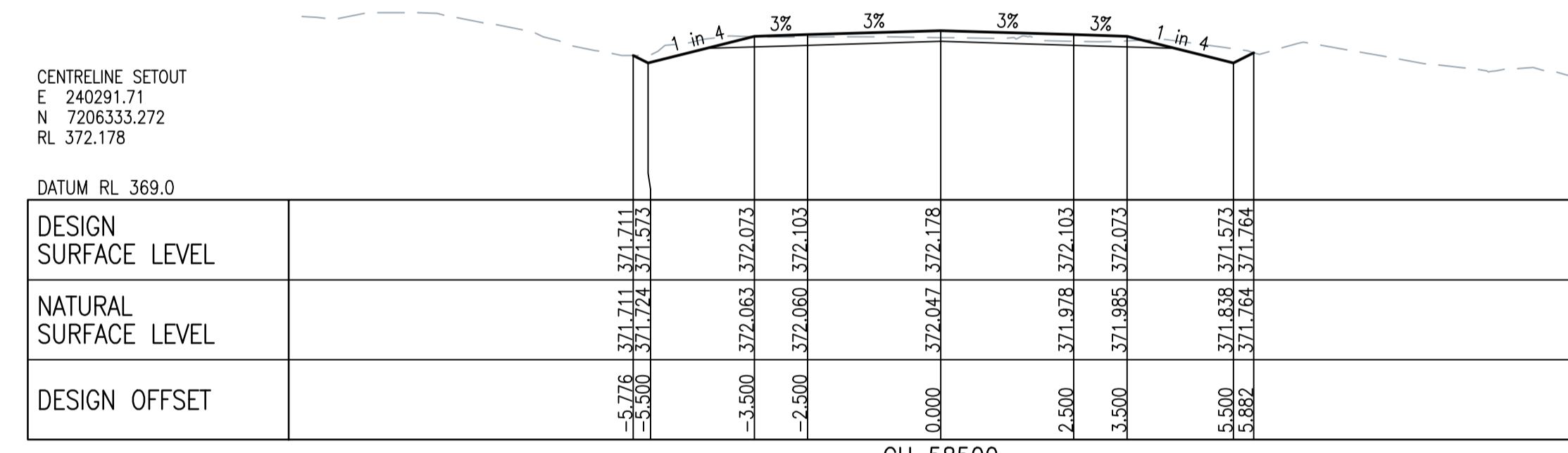

CH 58500

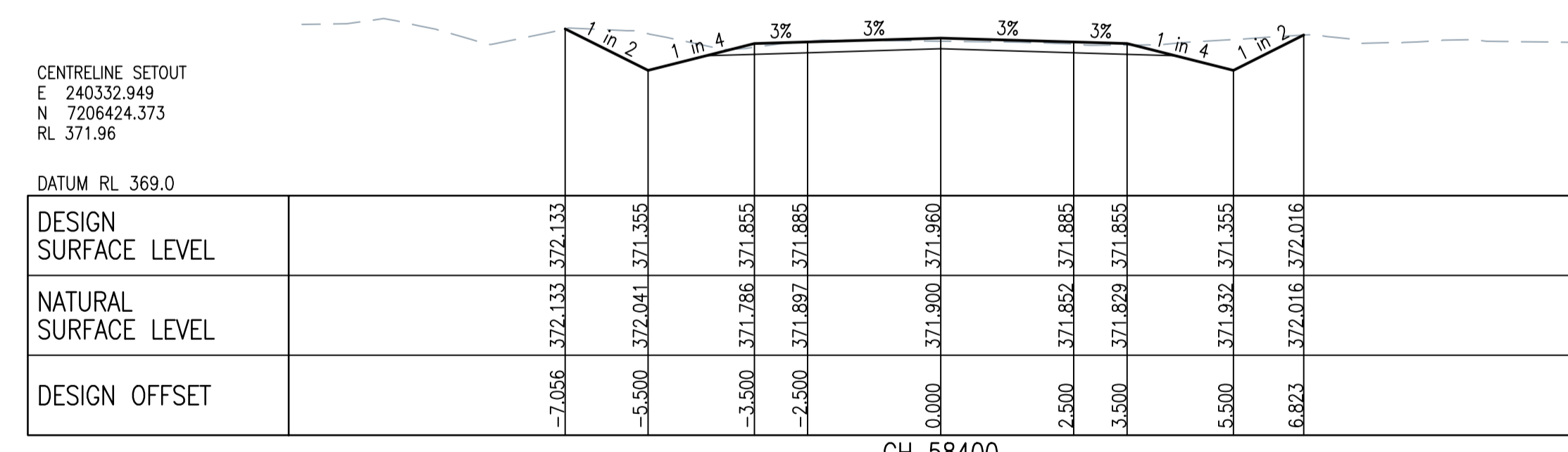

CH 58400

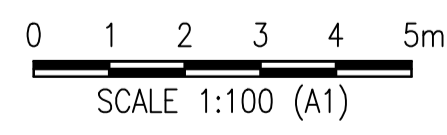

TENDER ISSUE ONLY

No.	Description	Reviewed	Approved	Date
1	TENDER ISSUE			23/08/2024



Client	BANANA SHIRE COUNCIL
Project	DEFENCE ROAD UPGRADE - CH 36,172 - CH68,499
Title	ANNOTATED CROSS SECTIONS SHEET 45 OF 64
Drawing No.	ARO0400-C94

Drawn	MS	Designed	MS	Approved	
Drawing Check		Design Check		RPEQ	Date

Scale (A1 size)
1:100

Drawing is not to be used for construction unless approved.

51 Sheridan Street
Cairns Qld 4870
T (07) 4281 6897
E admin@arindustries.com.au
W www.arindustries.com.au
ABN: 69 641 461 298

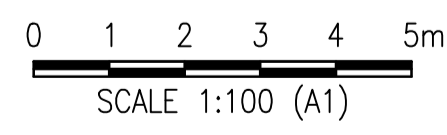
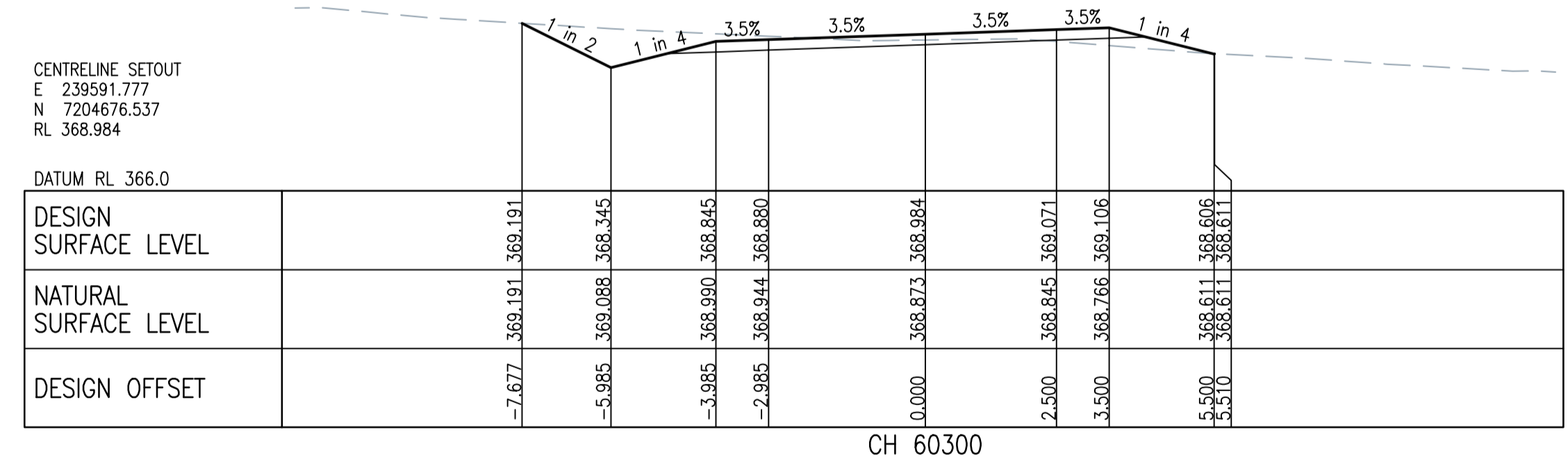
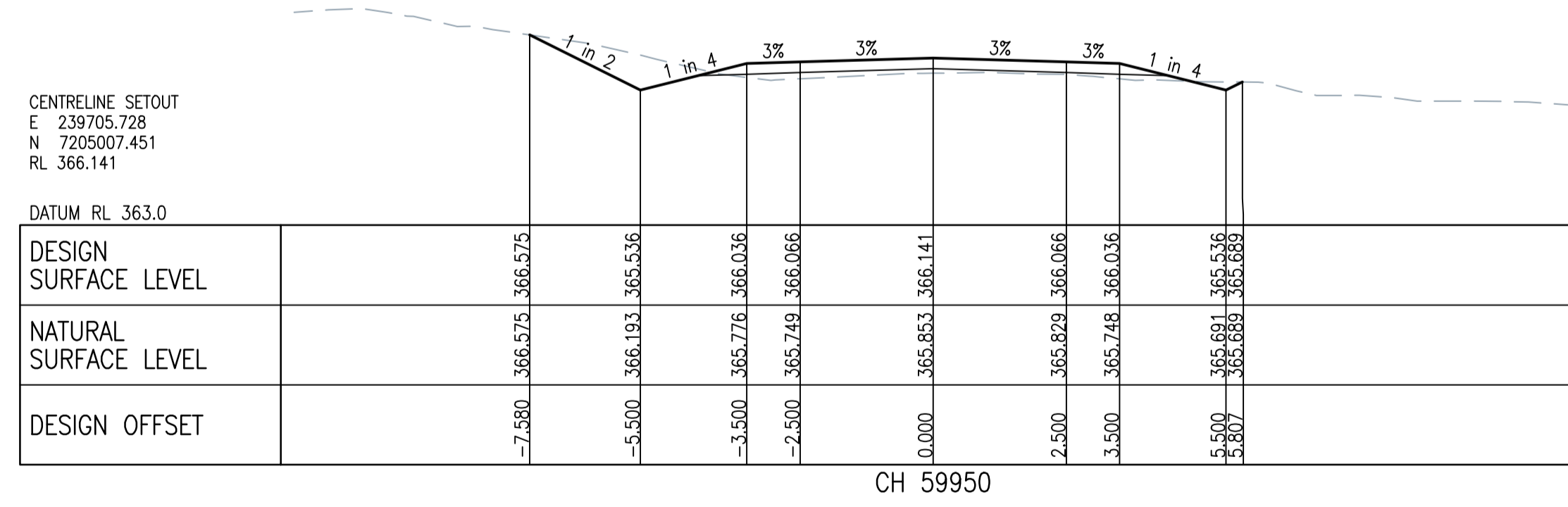
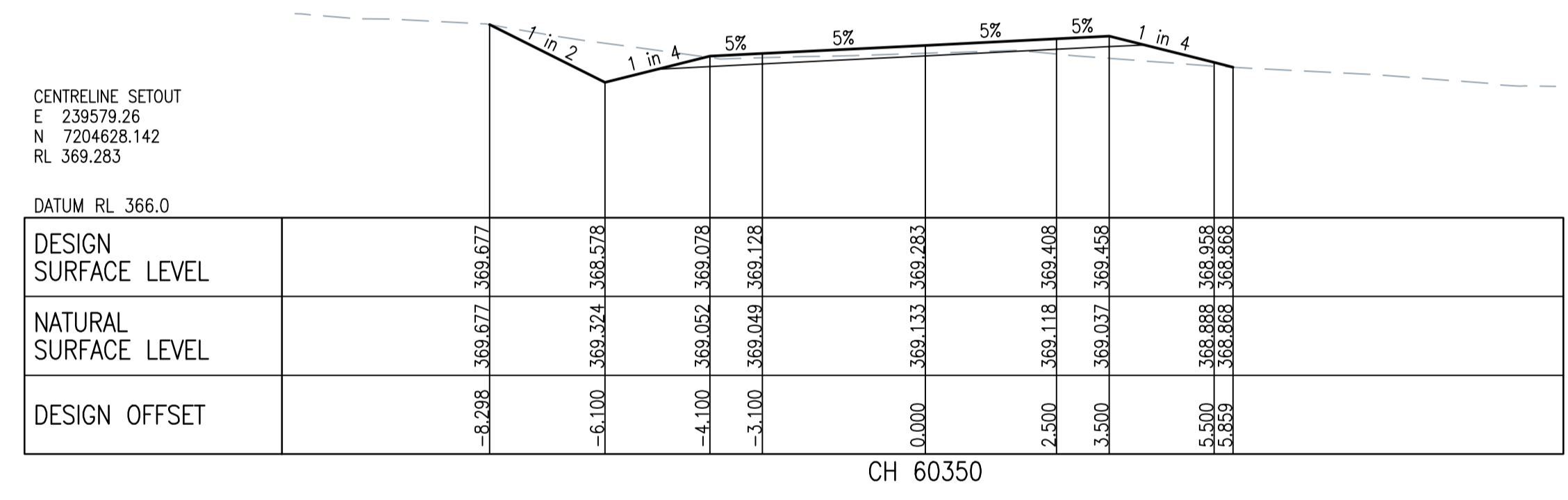
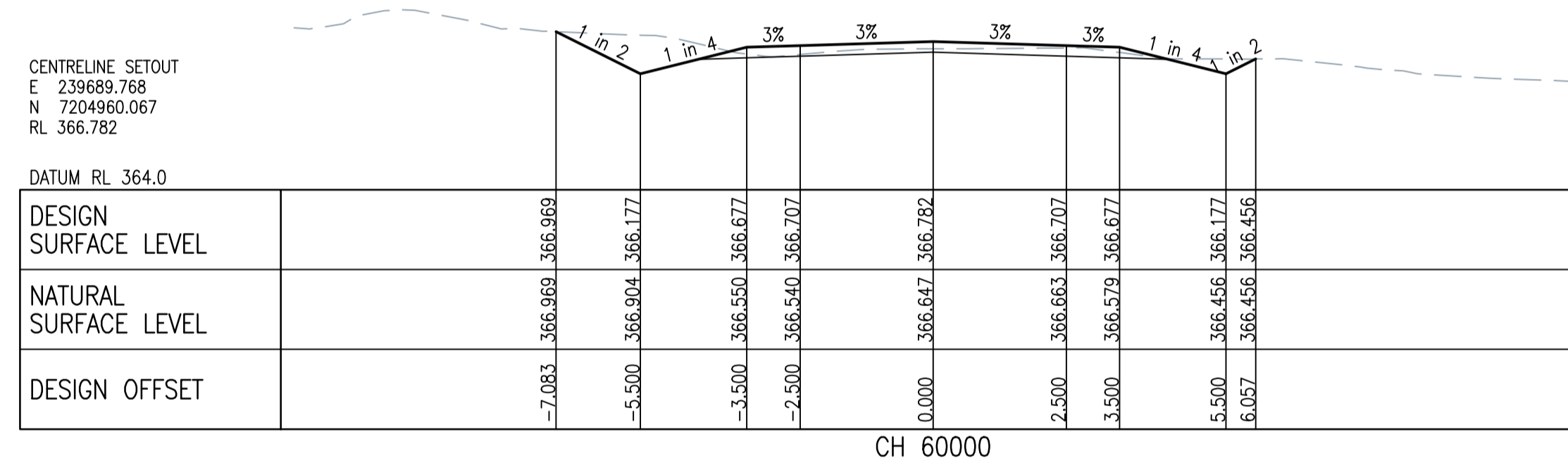
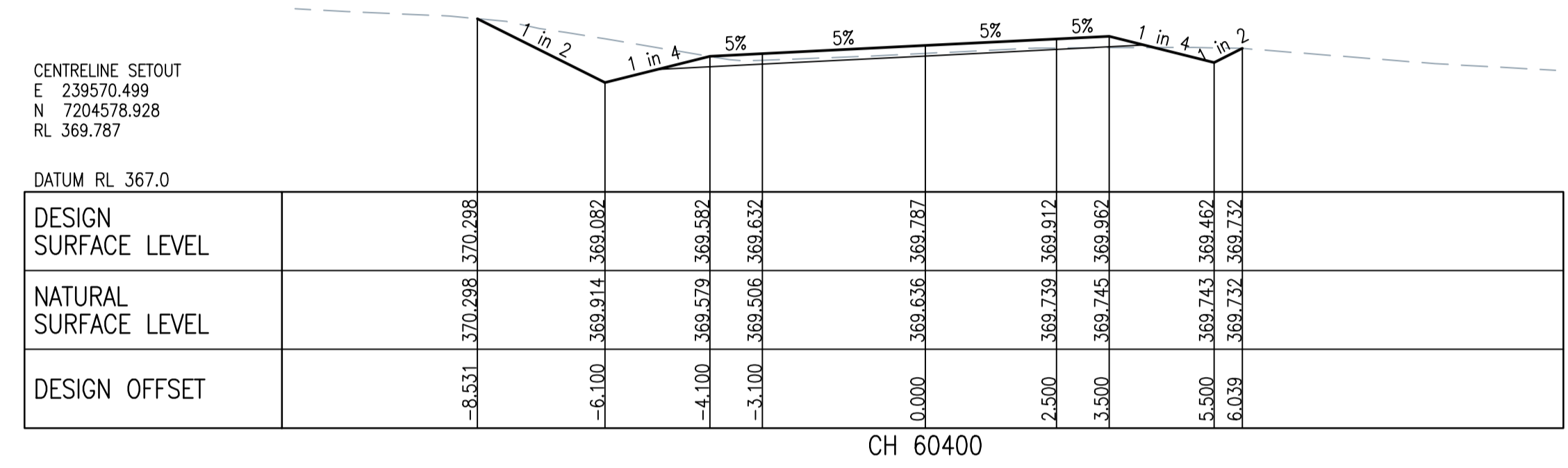
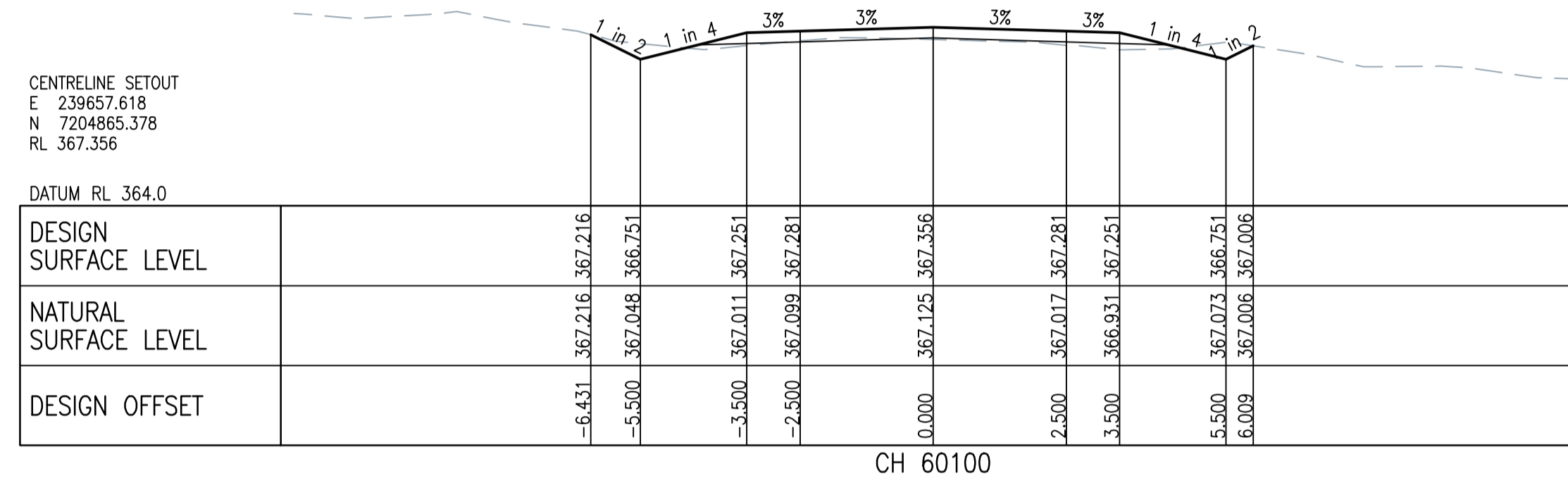
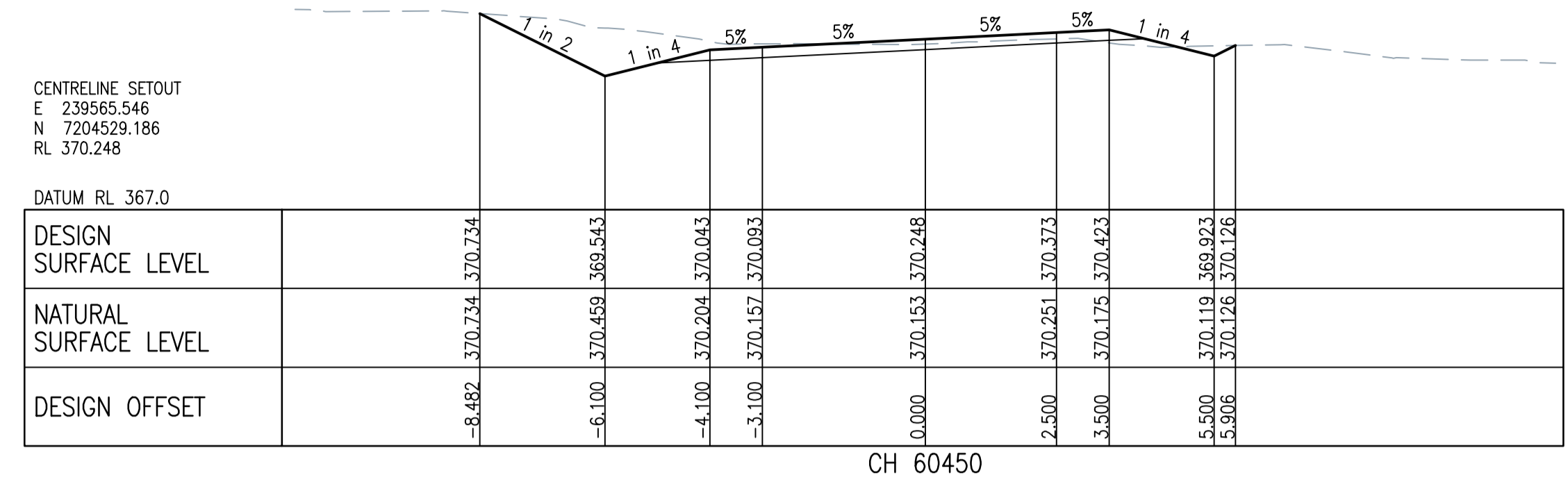
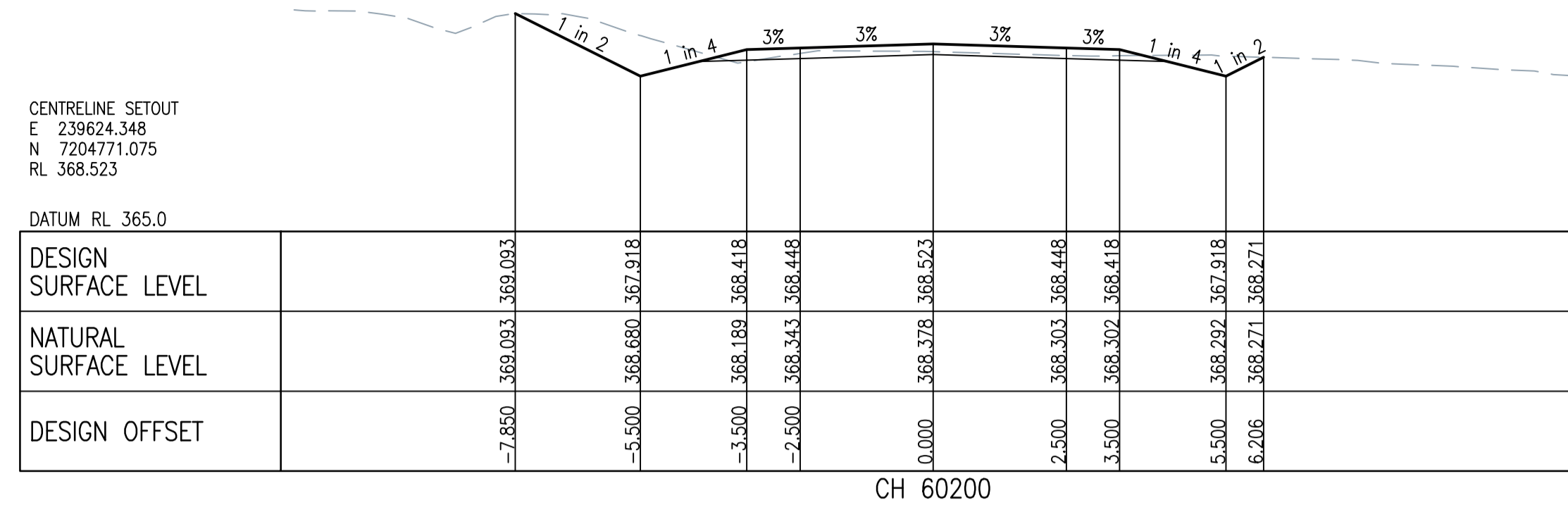

No.	Description	Reviewed	Approved	Date
1	TENDER ISSUE			23/08/2024



Client	BANANA SHIRE COUNCIL
Project	DEFENCE ROAD UPGRADE - CH 36,172 - CH68,499
Title	ANNOTATED CROSS SECTIONS SHEET 48 OF 64
Drawing No.	ARO0400-C97

Drawn	MS	Designed	MS	Approved		Scale (A1 size)	1:100
Drawing Check		Design Check		RPEQ	Date	Drawing is not to be used for construction unless approved.	

TENDER ISSUE ONLY

51 Sheridan Street
Cairns Qld 4870
T (07) 4281 6897
E admin@aroindustries.com.au
W www.aroindustries.com.au
ABN: 49 641 461 298

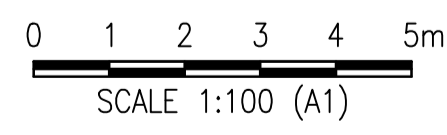
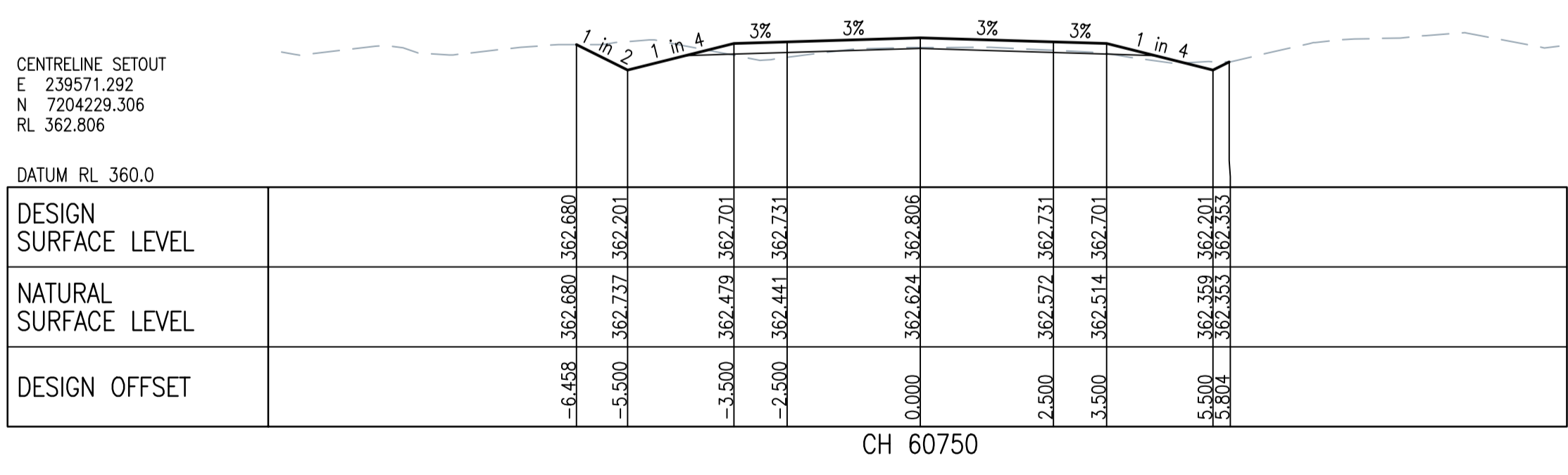
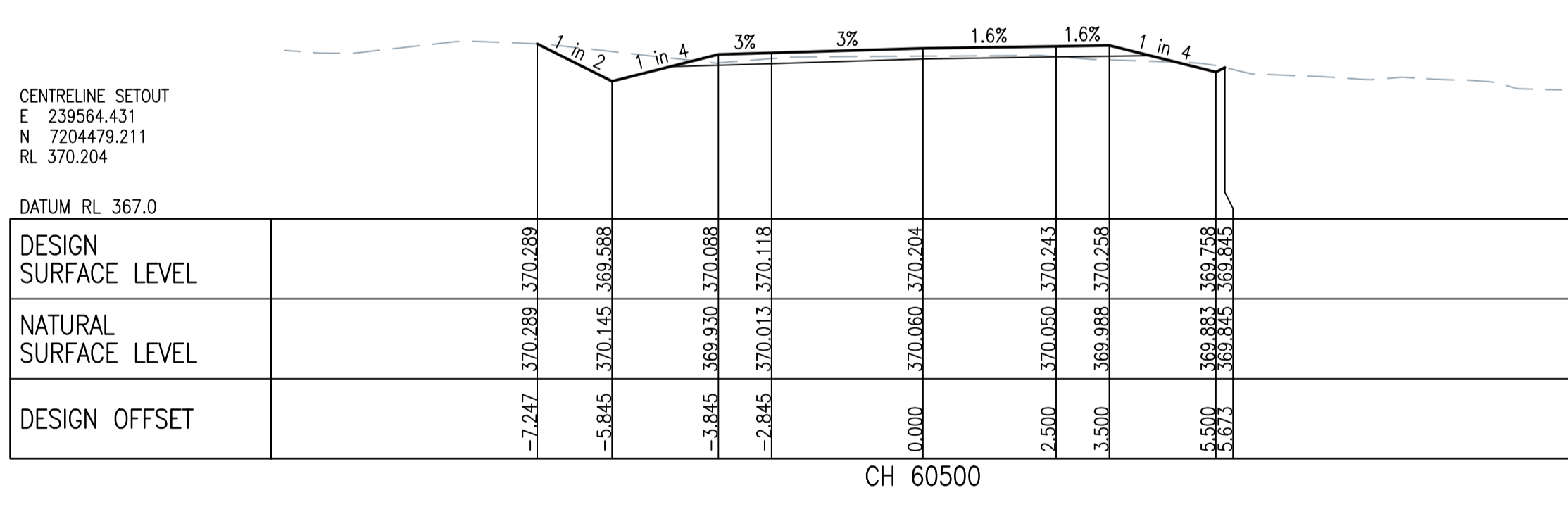
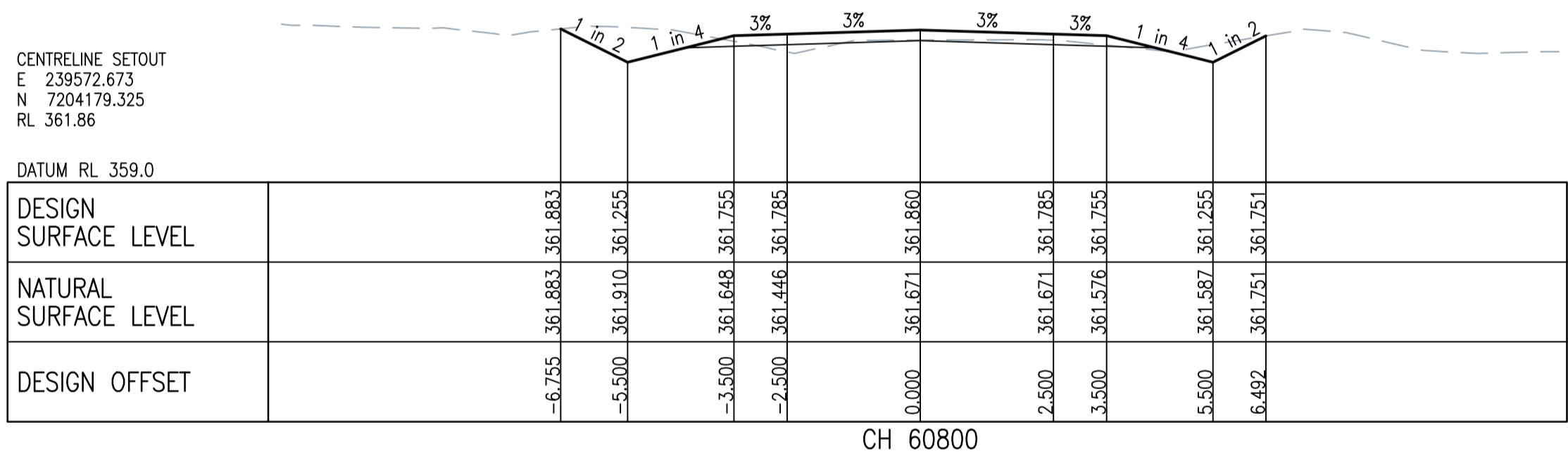
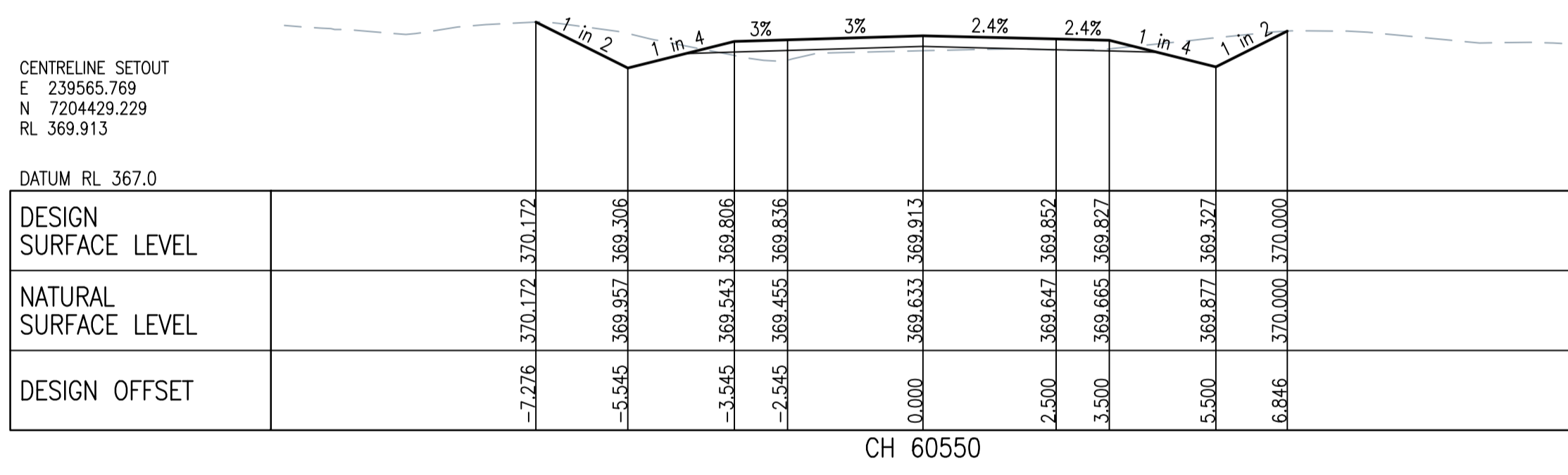
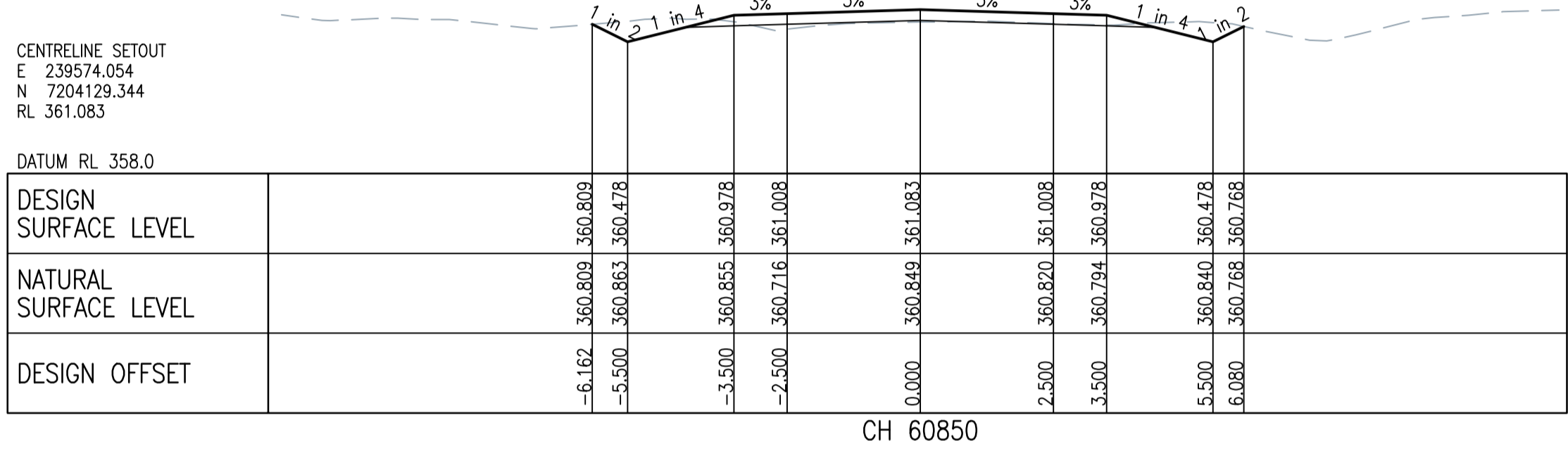
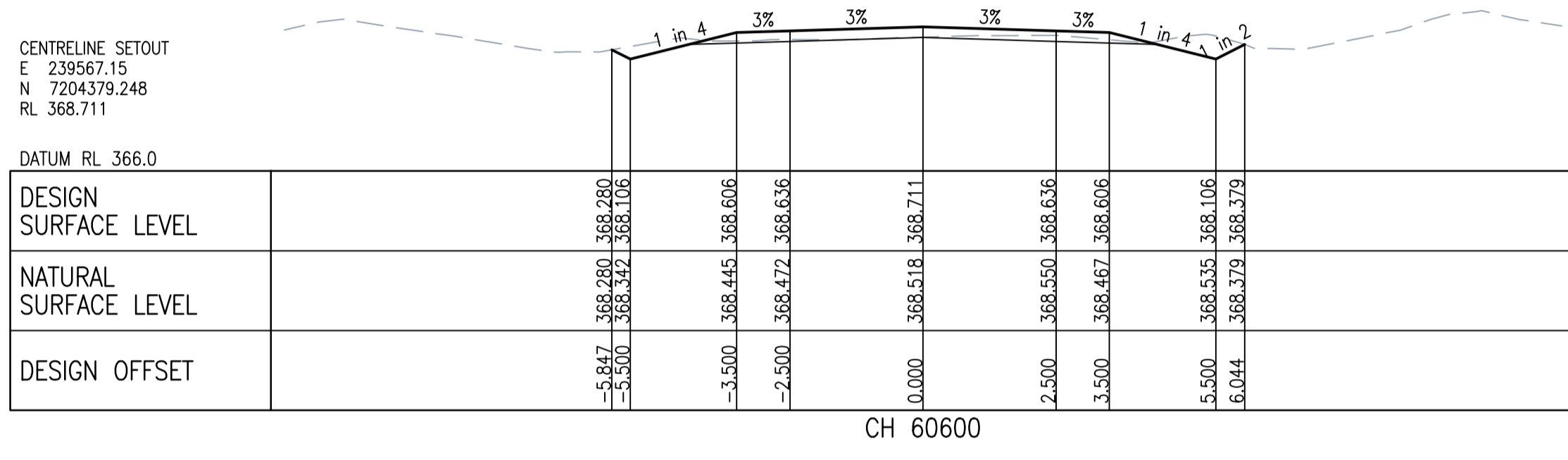
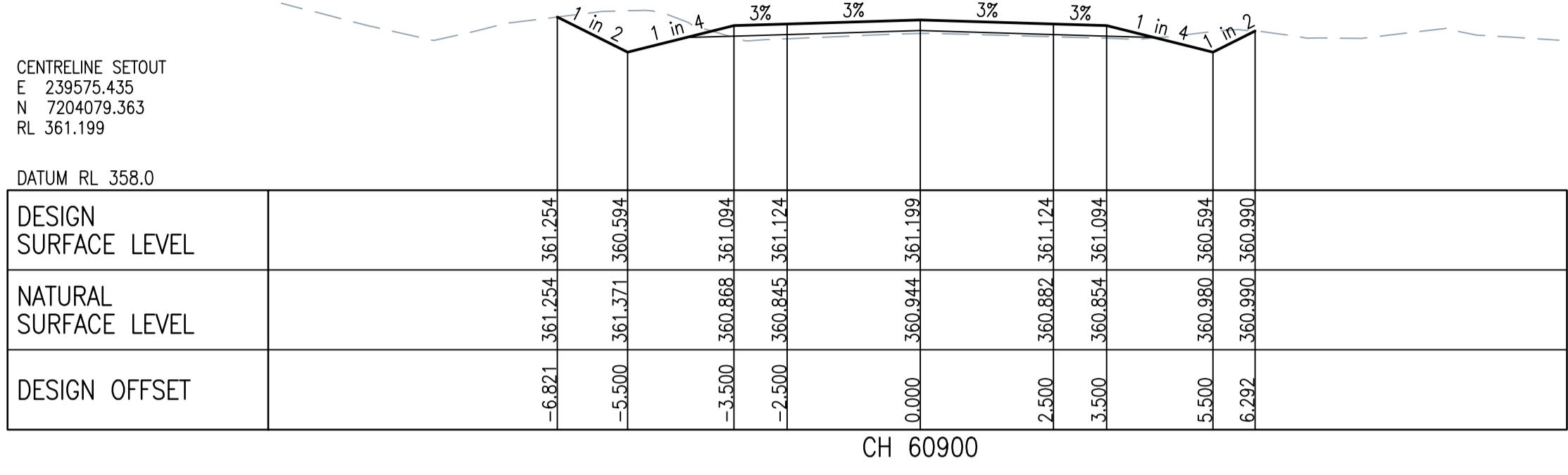
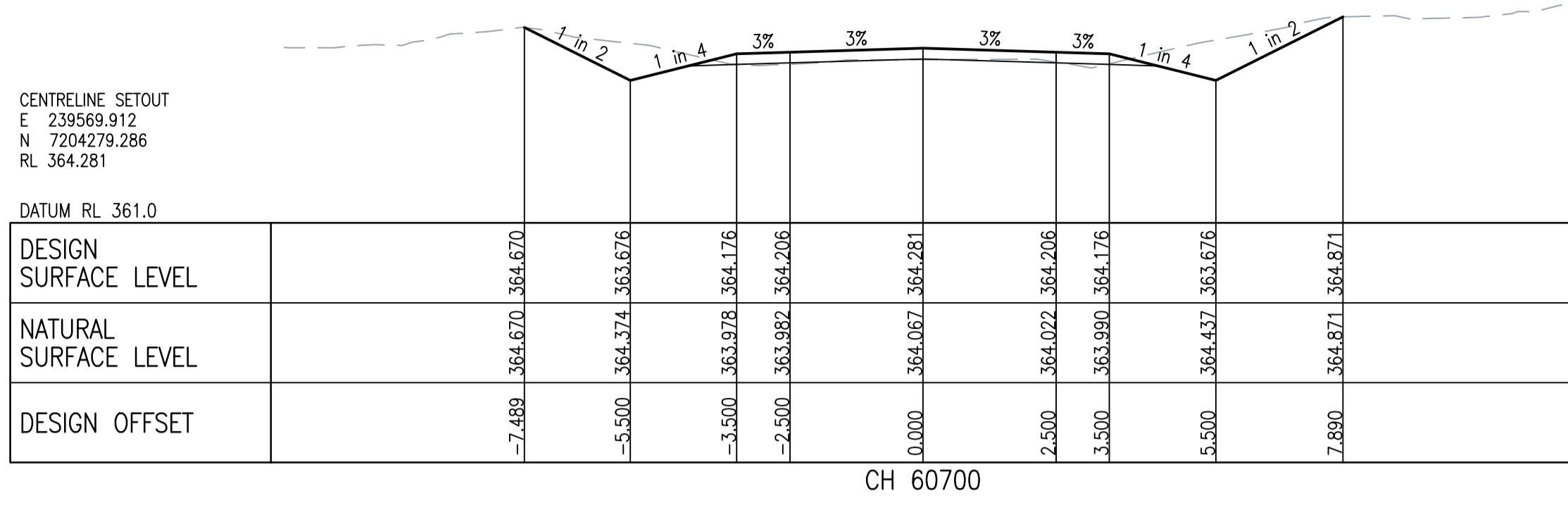

No.	Description	Reviewed	Approved	Date
1	TENDER ISSUE			23/08/2024



Client: BANANA SHIRE COUNCIL
Project: DEFENCE ROAD UPGRADE - CH 36,172 - CH68,499
Title: ANNOTATED CROSS SECTIONS SHEET 49 OF 64
Drawing No.: ARO0400-C98

Drawn: MS	Designed: MS	Approved:
Drawing Check	Design Check	RPEQ
		Date

Scale (A1 size): 1:100
Drawing is not to be used for construction unless approved.



51 Sheridan Street
Cairns Qld 4870
T (07) 4281 6897
E admin@arindustries.com.au
W www.arindustries.com.au
ABN: 49 641 461 298

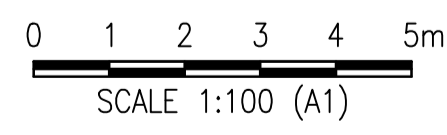
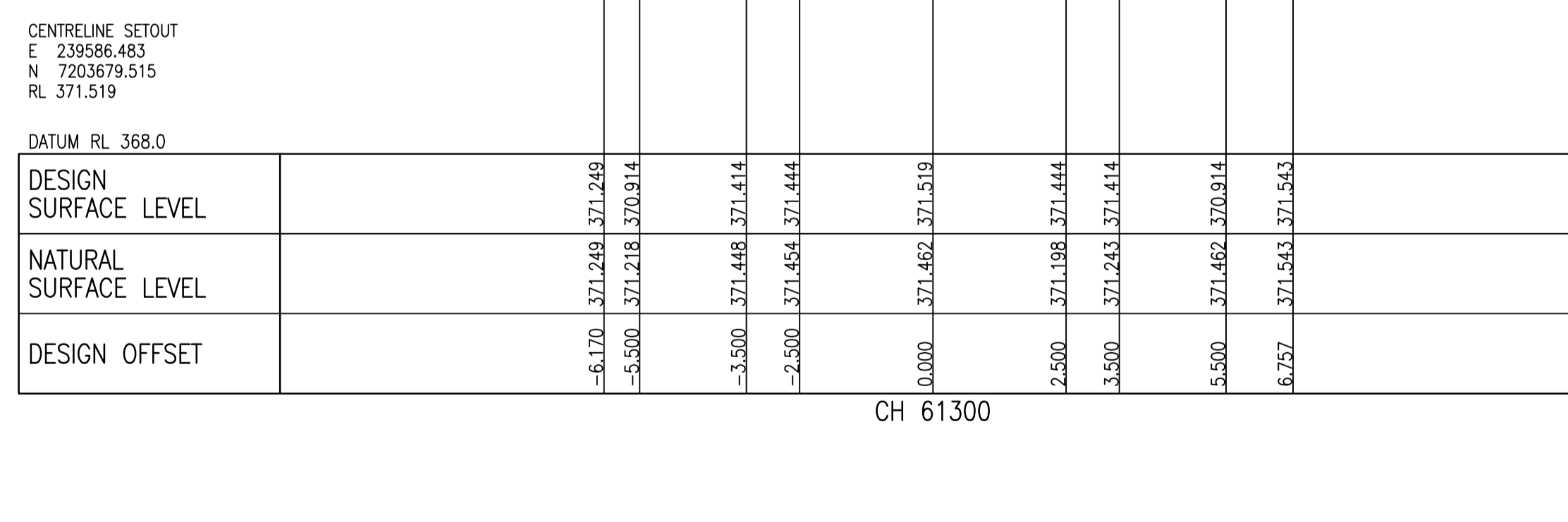
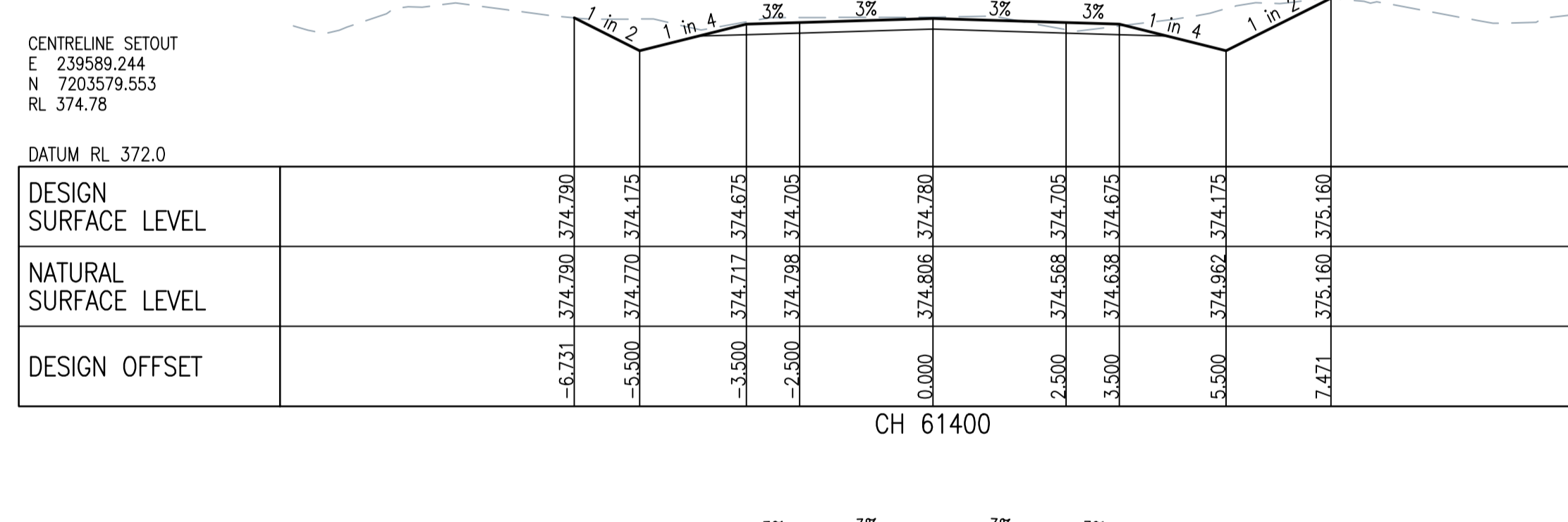
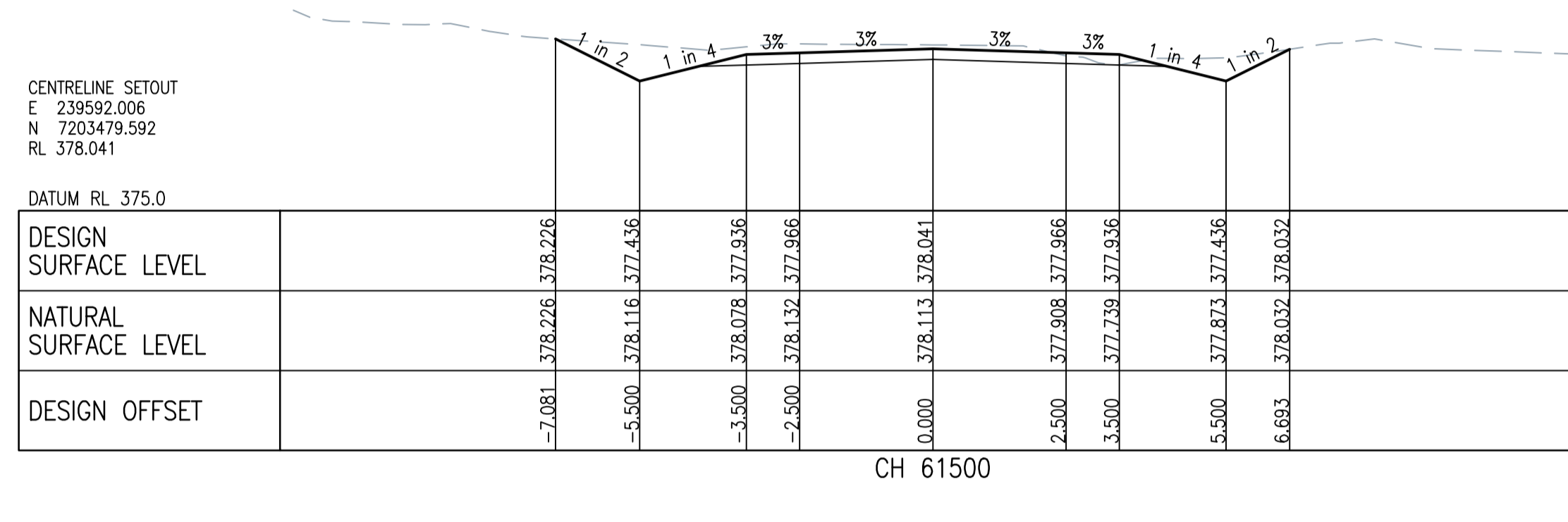
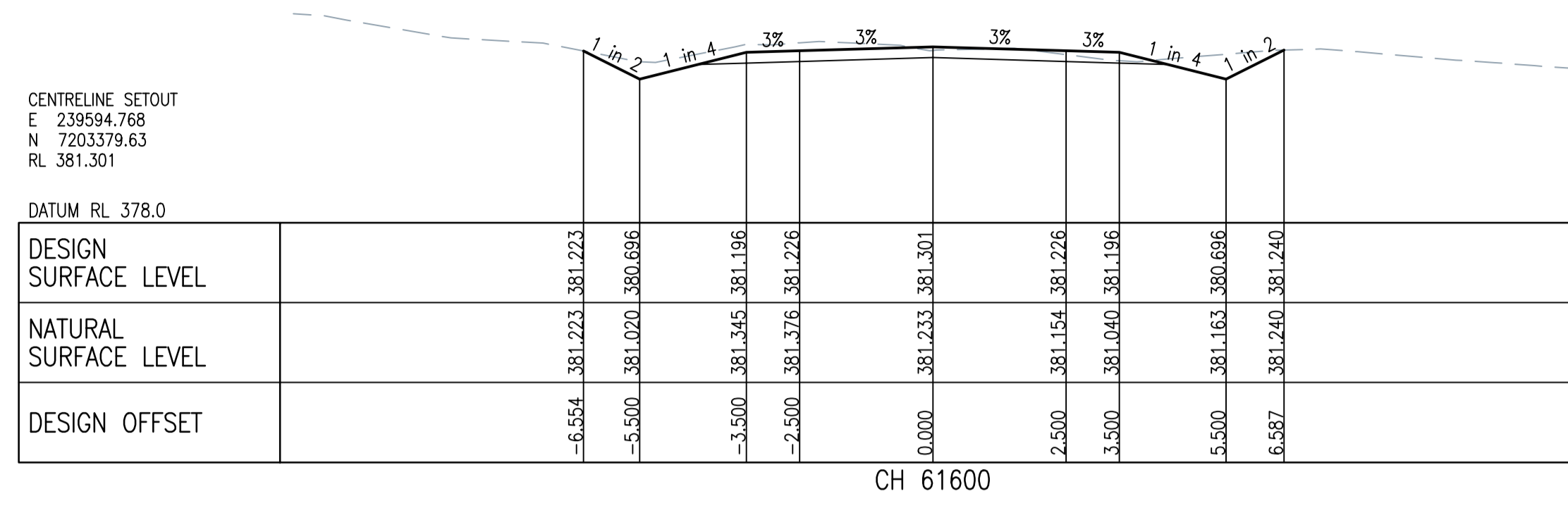
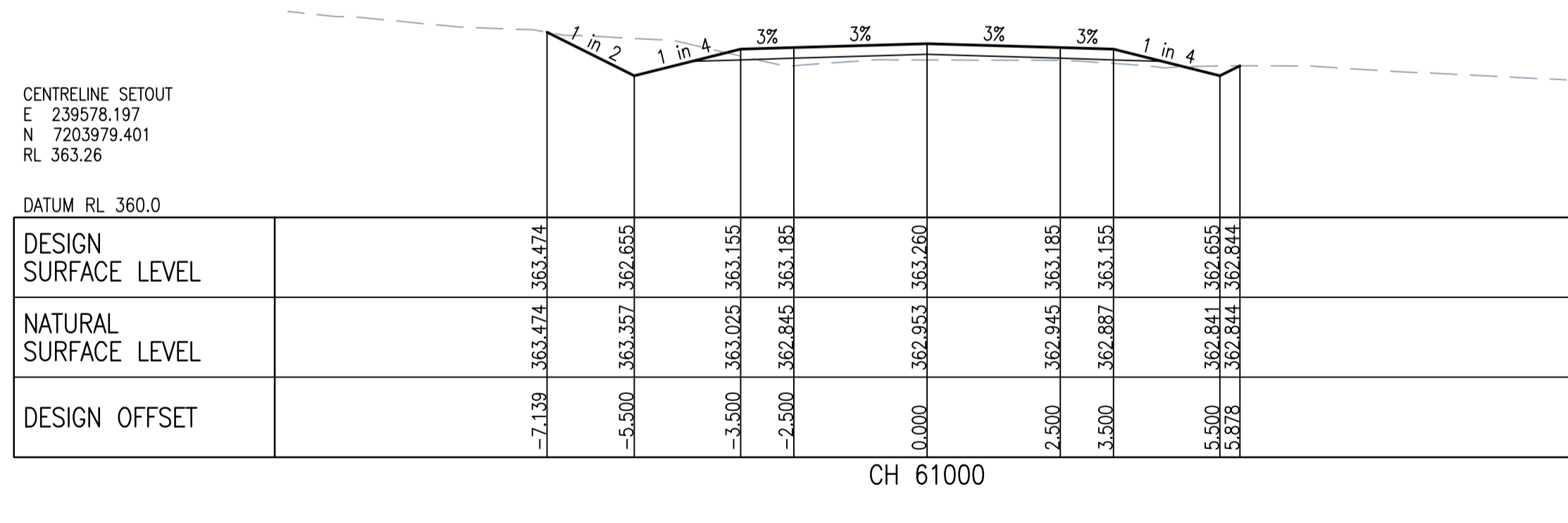
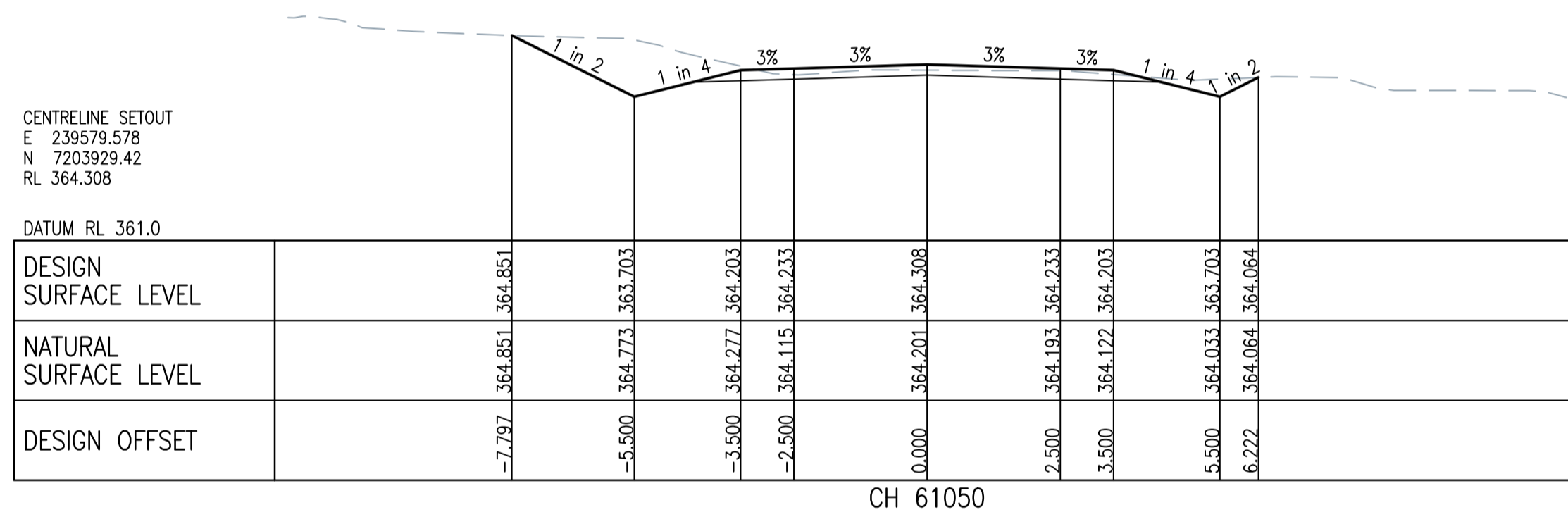
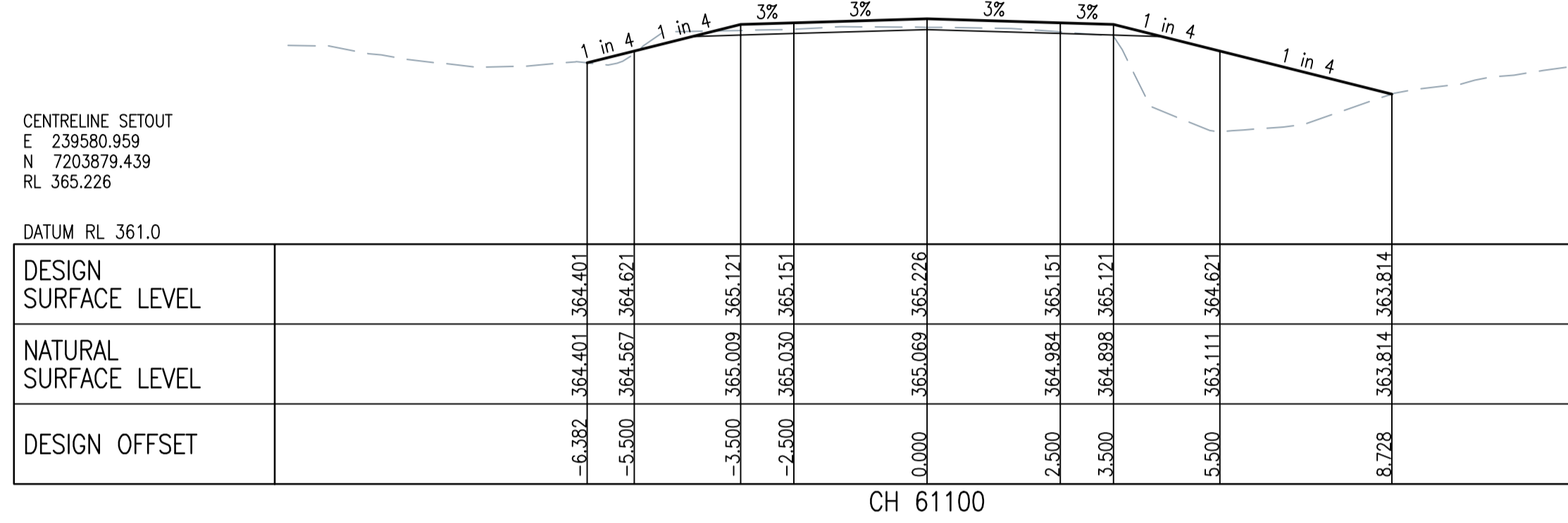
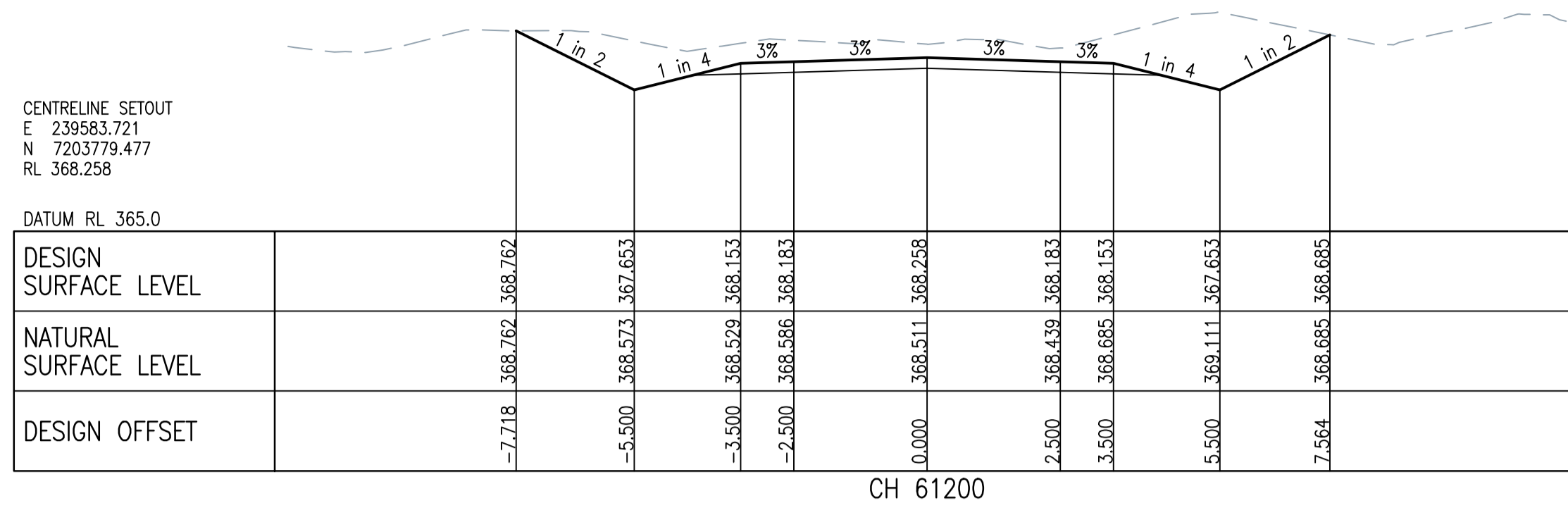

No.	Description	Reviewed	Approved	Date
1	TENDER ISSUE	-	-	23/08/2024



Client	BANANA SHIRE COUNCIL
Project	DEFENCE ROAD UPGRADE - CH 36,172 - CH68,499
Title	ANNOTATED CROSS SECTIONS SHEET 50 OF 64
Drawing No.	ARO0400-C99

Drawn	MS	Designed	MS	Approved	
Drawing Check		Design Check		RPEQ	Date

Scale (A1 size)
1:100

Drawing is not to be used for construction unless approved.

51 Sheridan Street
Cairns Qld 4870
T (07) 4281 6897
E admin@arindustries.com.au
W www.arindustries.com.au
ABN: 49 641 461 298

CENTRELINE SETOUT
E 239601.748
N 7203129.727
RL 391.672

DATUM RL 388.0

DESIGN SURFACE LEVEL										
NATURAL SURFACE LEVEL										
DESIGN OFFSET										

CH 61850

CENTRELINE SETOUT
E 239600.292
N 7203179.706
RL 388.976

DATUM RL 386.0

DESIGN SURFACE LEVEL										
NATURAL SURFACE LEVEL										
DESIGN OFFSET										

CH 61800

CENTRELINE SETOUT
E 239598.911
N 7203229.887
RL 386.447

DATUM RL 383.0

DESIGN SURFACE LEVEL										
NATURAL SURFACE LEVEL										
DESIGN OFFSET										

CH 61750

CENTRELINE SETOUT
E 239597.53
N 7203279.668
RL 384.562

DATUM RL 381.0

DESIGN SURFACE LEVEL										
NATURAL SURFACE LEVEL										
DESIGN OFFSET										

CH 61700

CENTRELINE SETOUT
E 239622.104
N 7202930.905
RL 390.16

DATUM RL 387.0

DESIGN SURFACE LEVEL										
NATURAL SURFACE LEVEL										
DESIGN OFFSET										

CH 62050

CENTRELINE SETOUT
E 239614.612
N 7202980.339
RL 391.5

DATUM RL 388.0

DESIGN SURFACE LEVEL										
NATURAL SURFACE LEVEL										
DESIGN OFFSET										

CH 62000

CENTRELINE SETOUT
E 239608.718
N 7203029.988
RL 392.723

DATUM RL 389.0

DESIGN SURFACE LEVEL										
NATURAL SURFACE LEVEL										
DESIGN OFFSET										

CH 61950

CENTRELINE SETOUT
E 239604.429
N 7203079.802
RL 392.756

DATUM RL 388.0

DESIGN SURFACE LEVEL										
NATURAL SURFACE LEVEL										
DESIGN OFFSET										

CH 61900

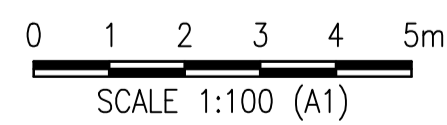

No.	Description	Reviewed	Approved	Date
1	TENDER ISSUE			23/08/2024



Client: BANANA SHIRE COUNCIL
Project: DEFENCE ROAD UPGRADE - CH 36,172 - CH68,499
Title: ANNOTATED CROSS SECTIONS SHEET 51 OF 64

Drawn	Designed	Approved
MS	MS	
Drawing Check	Design Check	RPEQ
		Date

Scale (A1 size)
1:100
Drawing is not to be used for construction unless approved.

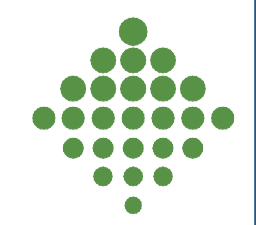

ARO

51 Sheridan Street
Cairns Qld 4870
T (07) 4281 6897
E admin@aroindustries.com.au
W www.aroindustries.com.au
ABN: 49 641 461 298

TENDER ISSUE ONLY

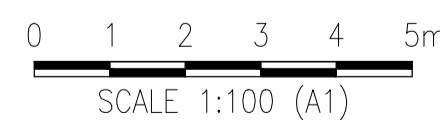
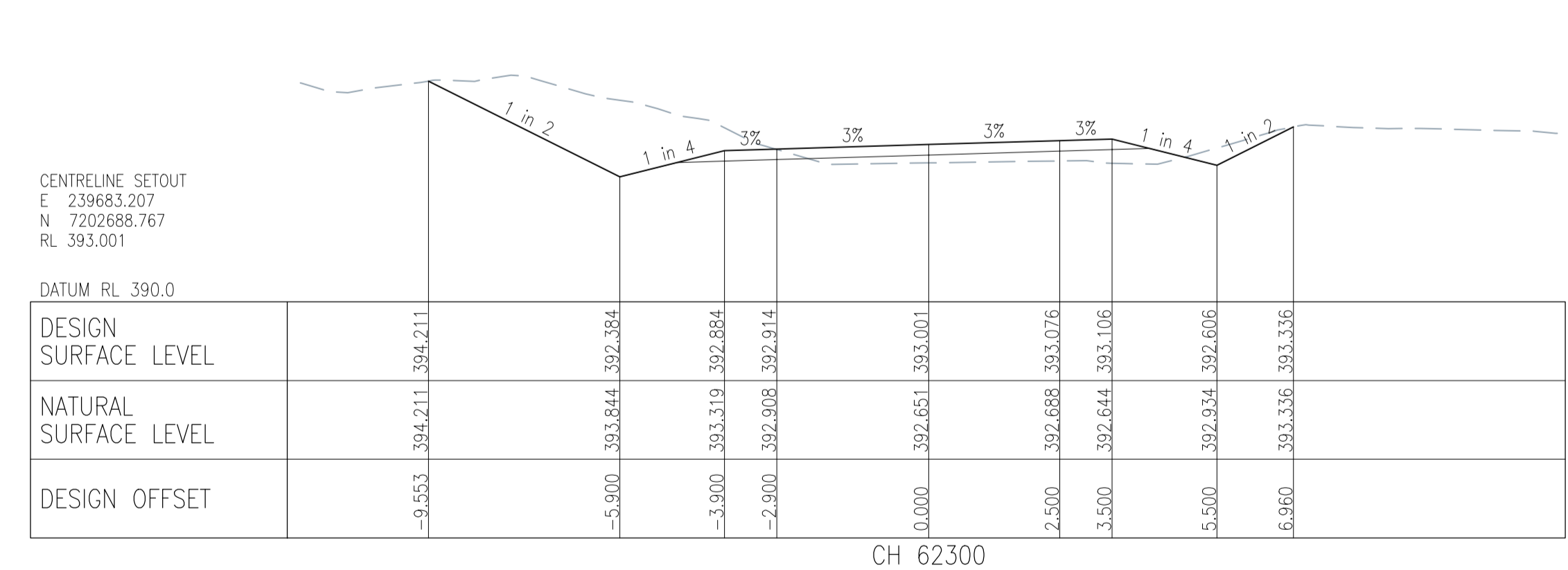
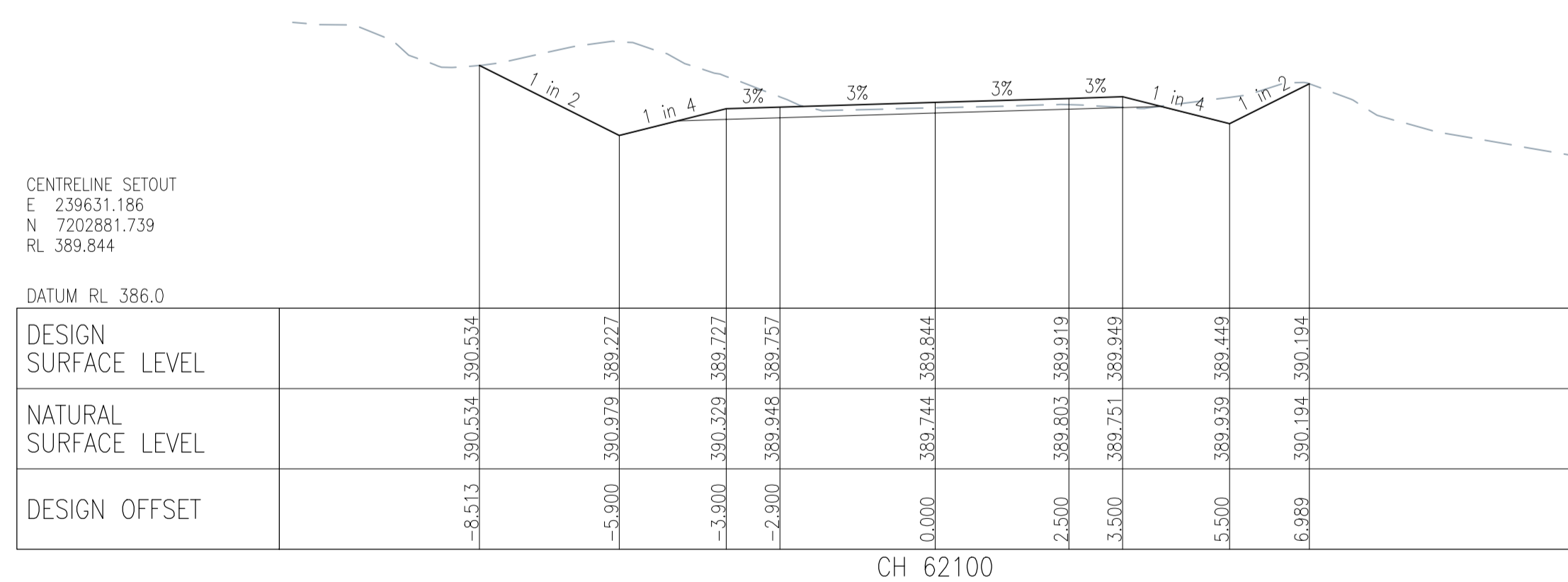
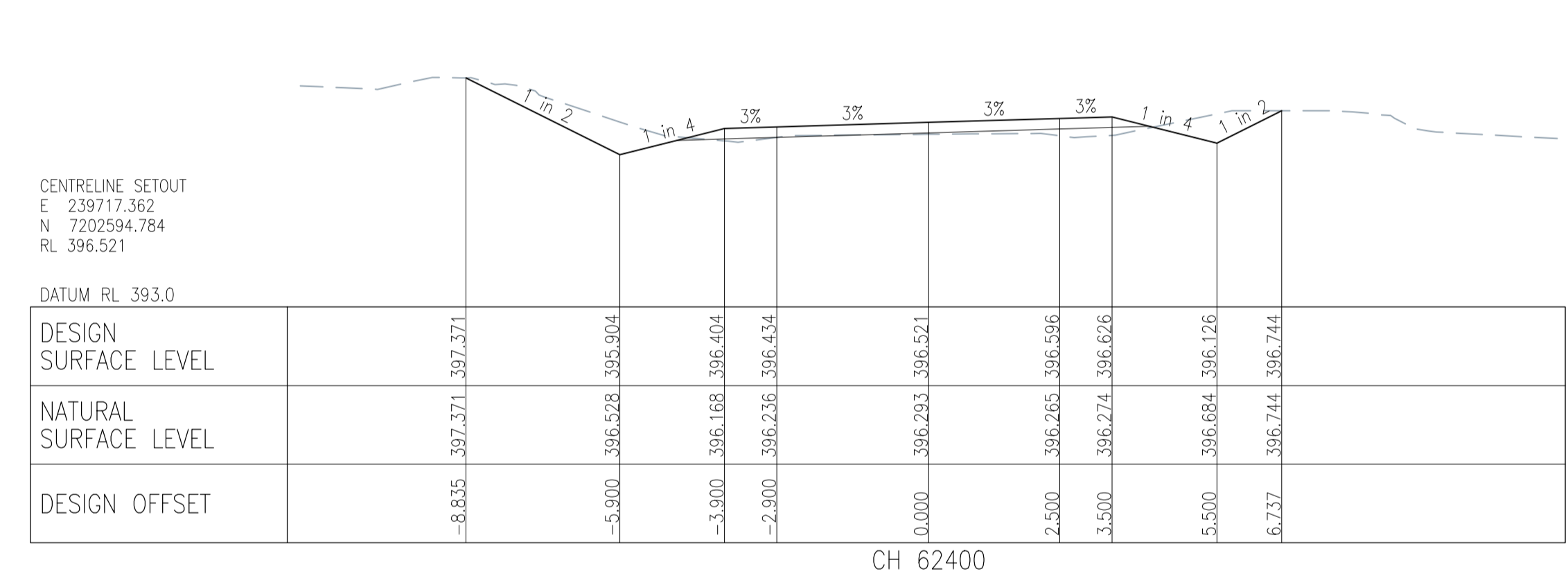
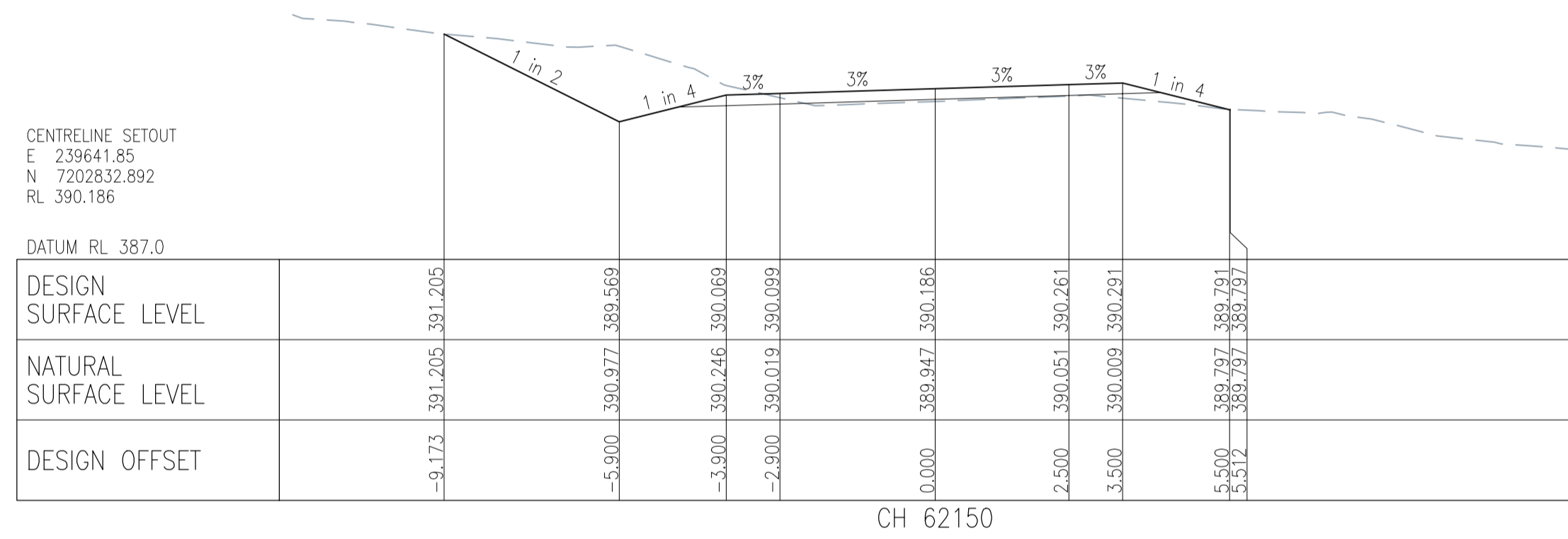
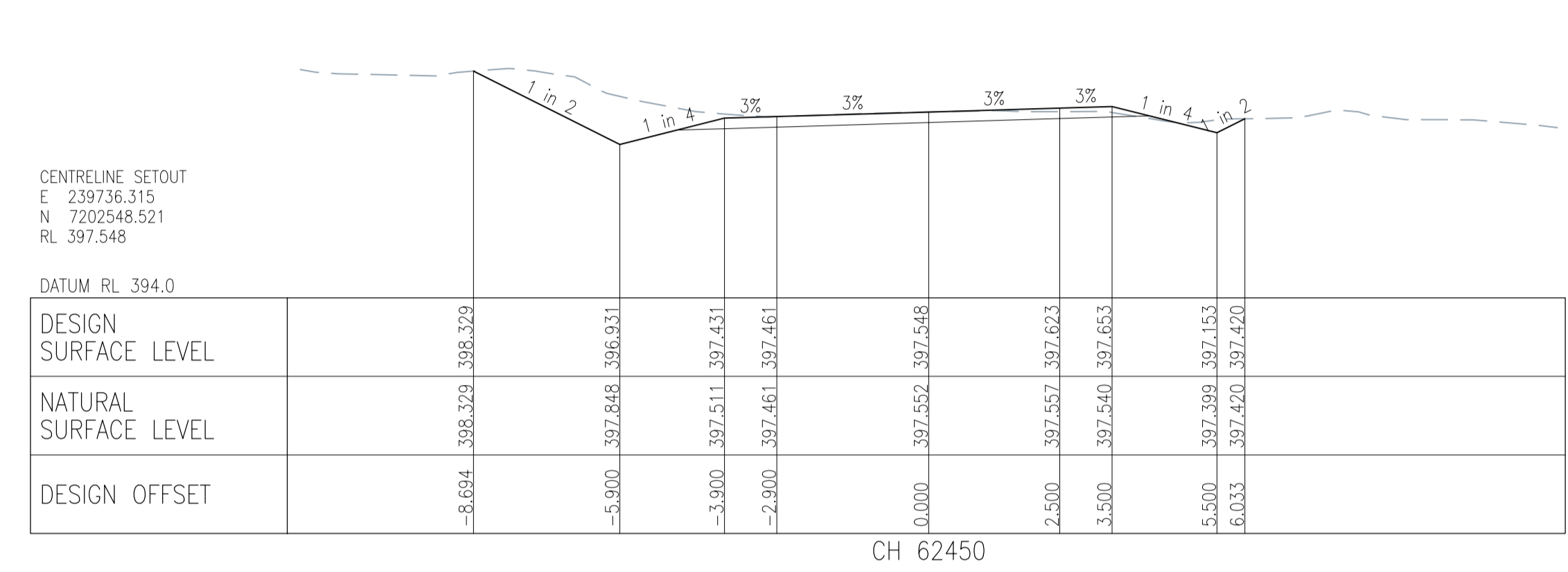
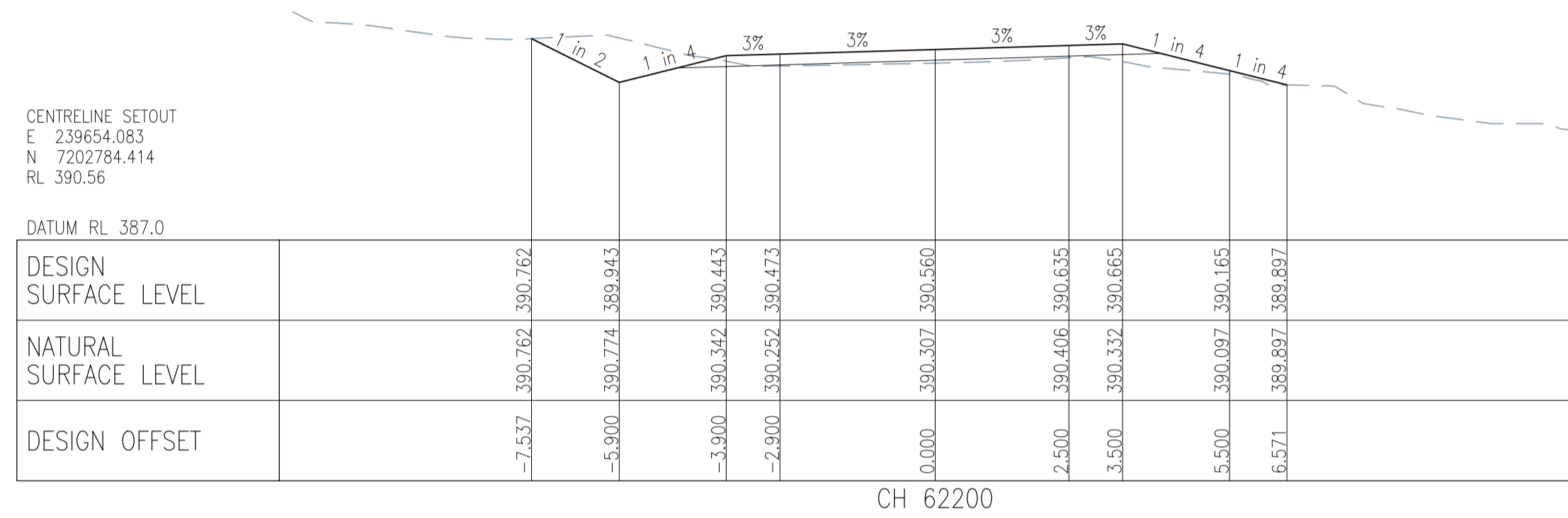
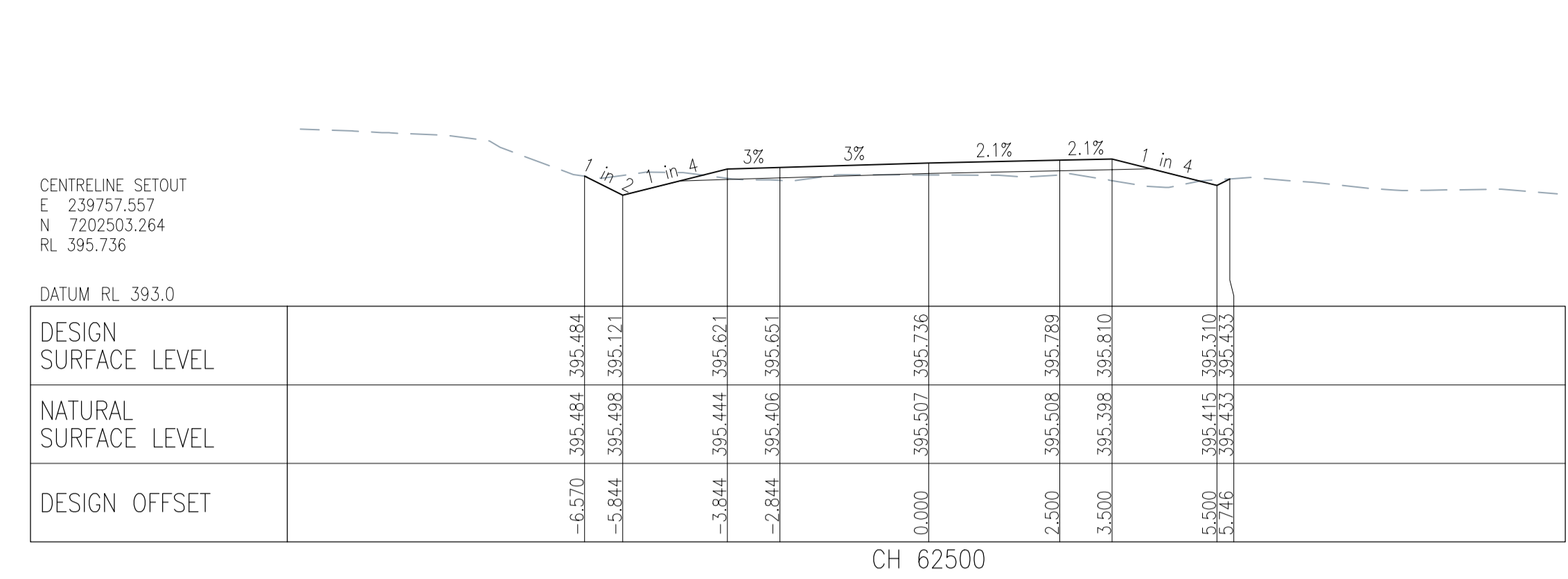
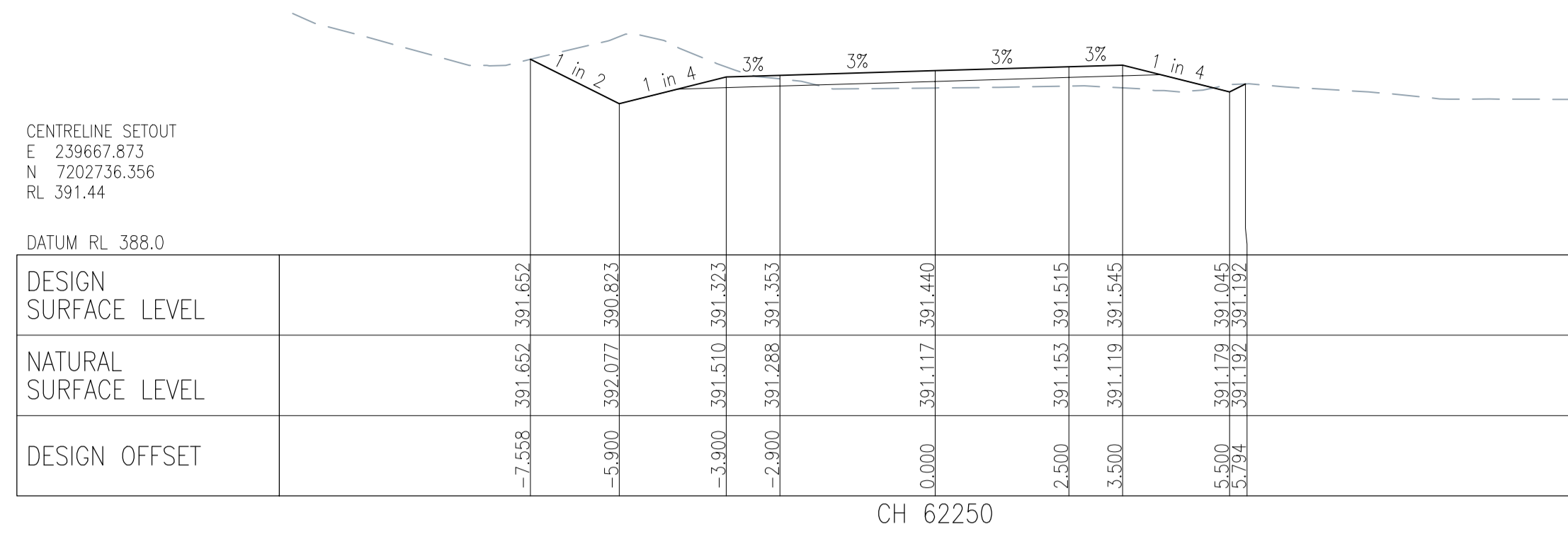

TENDER ISSUE ONLY

No.	Description	Reviewed	Approved	Date
1	TENDER ISSUE	-	-	23/08/2024



Client	BANANA SHIRE COUNCIL
Project	DEFENCE ROAD UPGRADE - CH 36,172 - CH68,499
Title	ANNOTATED CROSS SECTIONS SHEET 52 OF 64

Drawn	MS	Designed	MS	Approved	
Drawing Check		Design Check		RPEQ	Date

Scale (A1 size)	1:100
Drawing is not to be used for construction unless approved.	



51 Sheridan Street
Cairns Qld 4870
T (07) 4281 6897
E admin@arindustries.com.au
W www.arindustries.com.au
ABN: 49 641 461 298

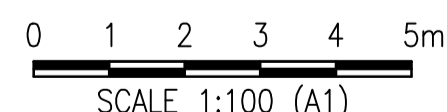
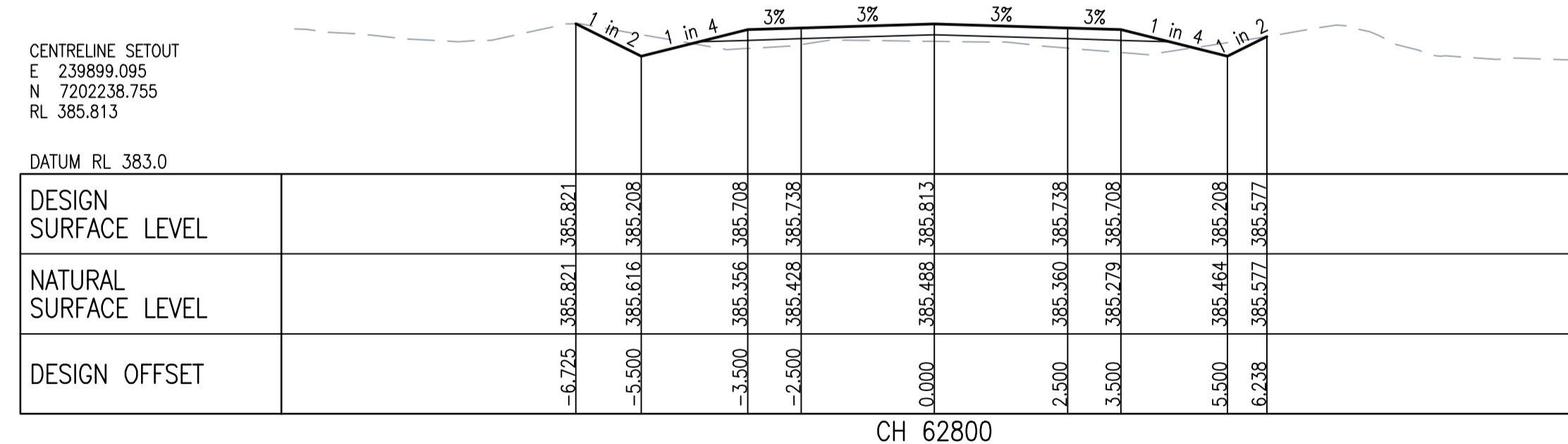
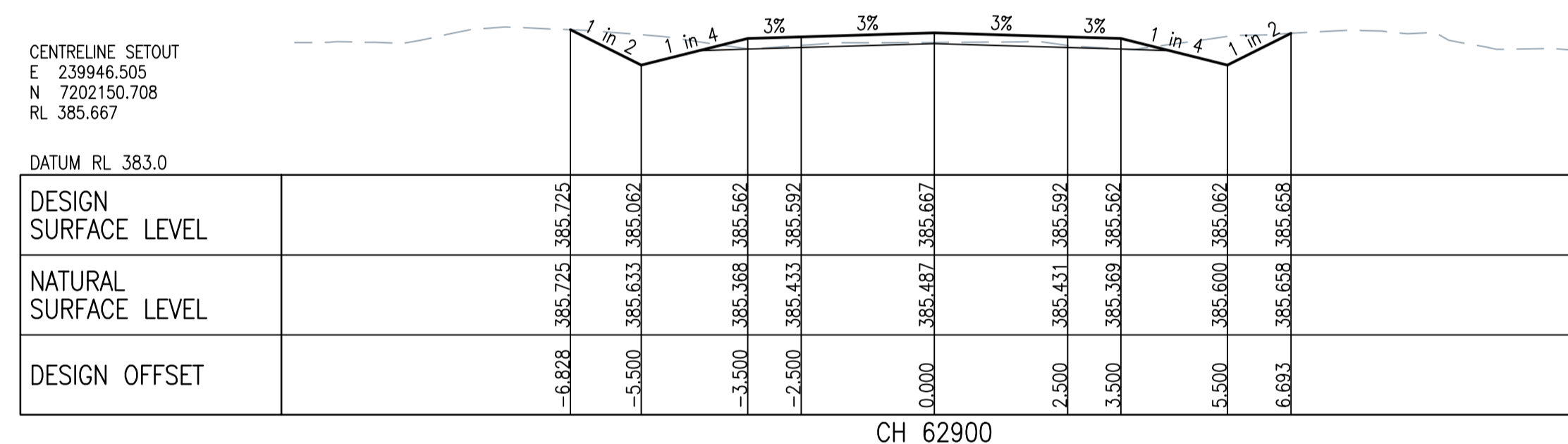
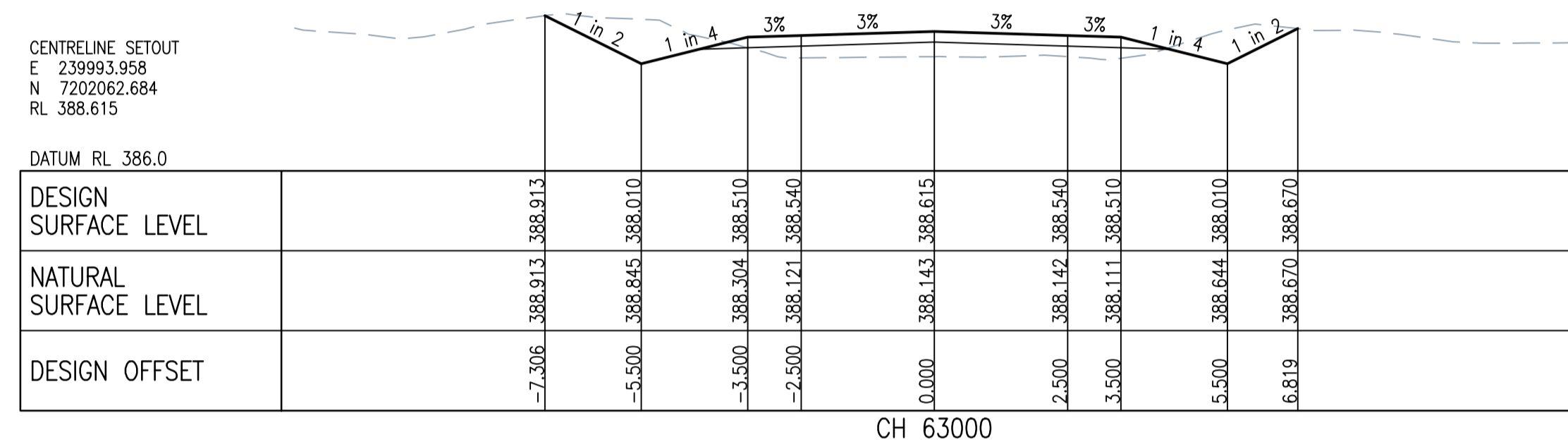
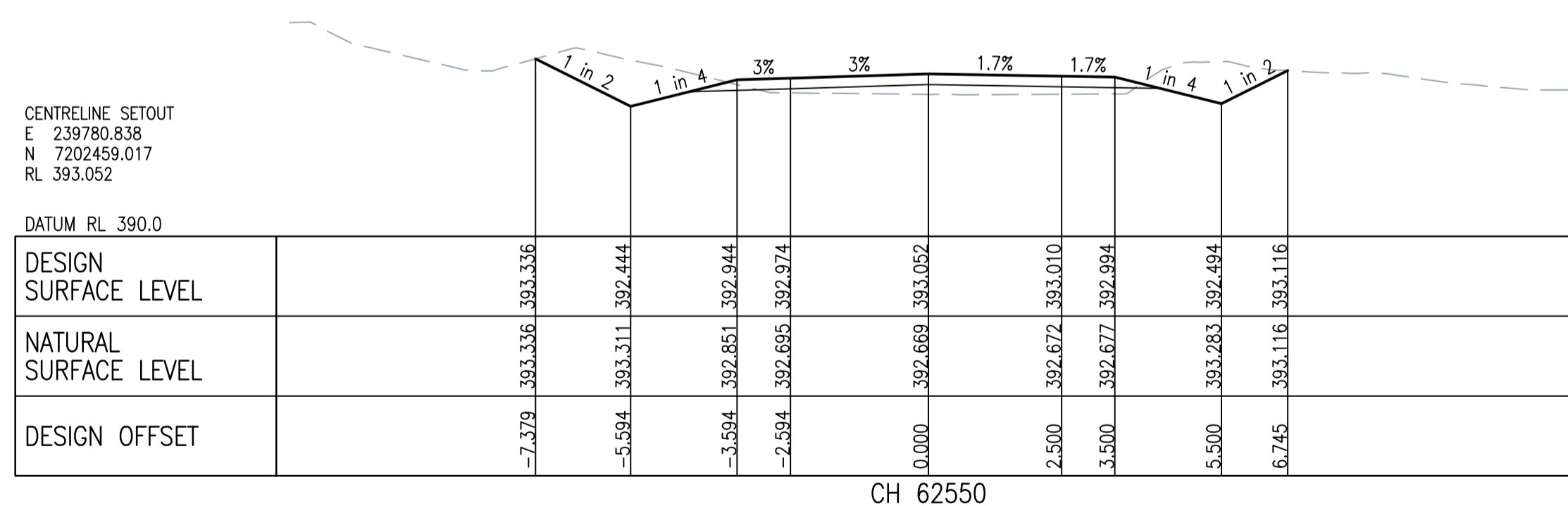
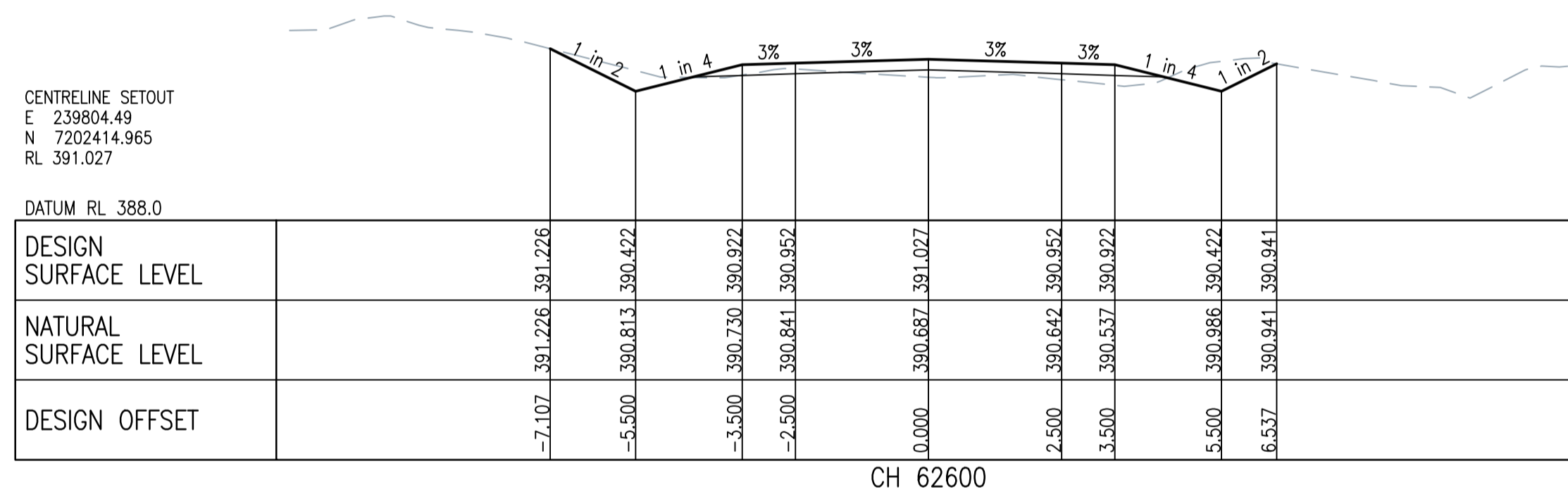
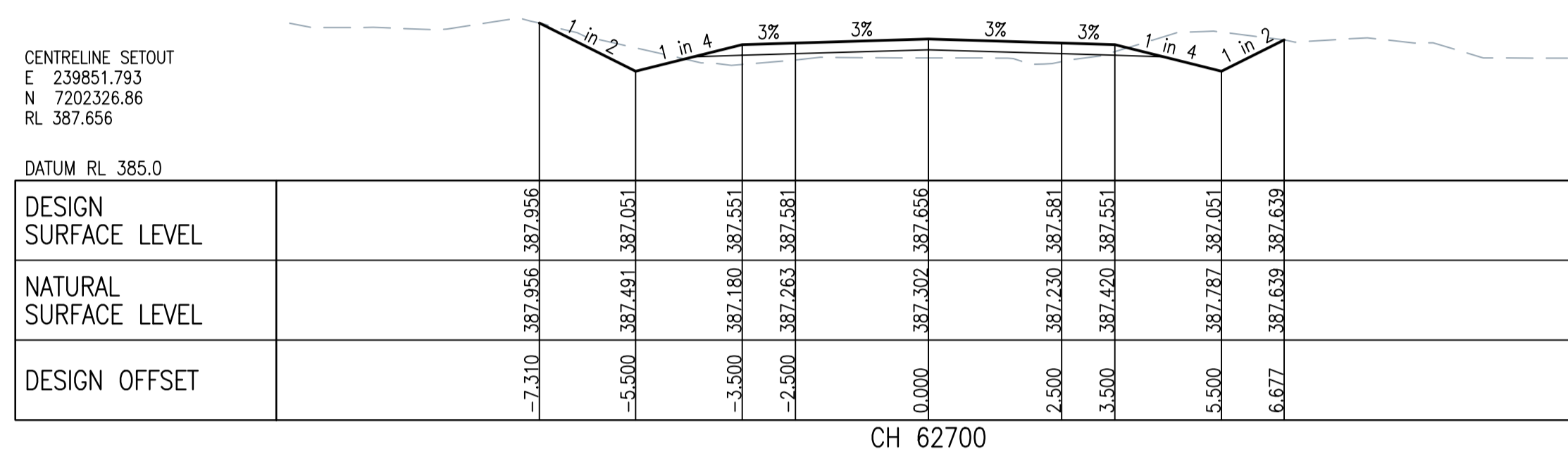
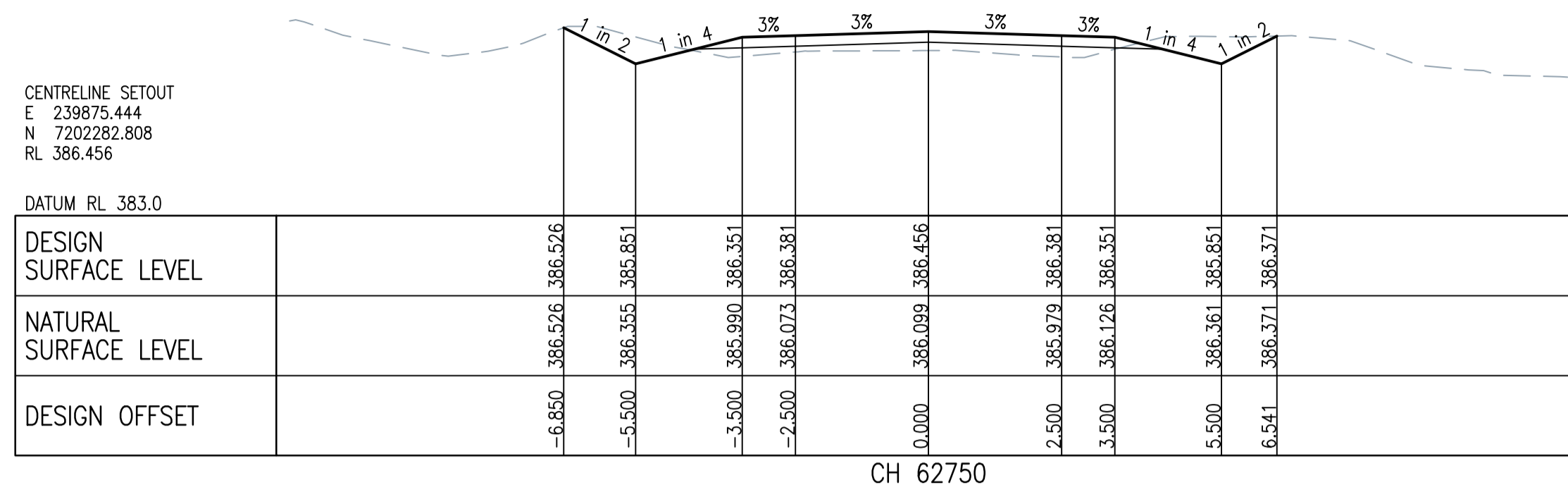

No.	Description	Reviewed	Approved	Date
1	TENDER ISSUE			23/08/2024



Client: BANANA SHIRE COUNCIL
Project: DEFENCE ROAD UPGRADE - CH 36,172 - CH68,499
Title: ANNOTATED CROSS SECTIONS SHEET 53 OF 64

Drawn: MS	Designed: MS	Approved:
Drawing Check	Design Check	RPEQ
		Date

Scale (A1 size): 1:100
Drawing is not to be used for construction unless approved.



51 Sheridan Street
Cairns Qld 4870
T (07) 4281 6897
E admin@arindustries.com.au
W www.arindustries.com.au
ABN: 49 641 461 298

TENDER ISSUE ONLY

CENTRELINE SETOUT
E 240323.462
N 7201445.113
RL 410.781

DATUM RL 407.0

DESIGN SURFACE LEVEL			410.423	410.176																
NATURAL SURFACE LEVEL			410.423	410.176																
DESIGN OFFSET			-5.995	-5.500																

CH 63700

CENTRELINE SETOUT
E 240275.997
N 7201533.13
RL 416.152

DATUM RL 413.0

DESIGN SURFACE LEVEL			417.749	415.547																
NATURAL SURFACE LEVEL			417.749	415.547																
DESIGN OFFSET			-9.905	-5.500																

CH 63600

CENTRELINE SETOUT
E 240228.532
N 7201621.148
RL 414.927

DATUM RL 412.0

DESIGN SURFACE LEVEL			414.677	414.922																
NATURAL SURFACE LEVEL			414.677	414.922																
DESIGN OFFSET			-6.211	-5.500																

CH 63500

CENTRELINE SETOUT
E 240204.799
N 7201665.156
RL 412.631

DATUM RL 410.0

DESIGN SURFACE LEVEL			412.521	412.026																
NATURAL SURFACE LEVEL			412.521	412.026																
DESIGN OFFSET			-6.489	-5.500																

CH 63450

CENTRELINE SETOUT
E 240417.736
N 7201268.726
RL 403.01

DATUM RL 400.0

DESIGN SURFACE LEVEL			403.041	402.405																
NATURAL SURFACE LEVEL			403.041	402.405																
DESIGN OFFSET			-6.771	-5.500																

CH 63900

CENTRELINE SETOUT
E 240394.202
N 7201312.841
RL 404.952

DATUM RL 402.0

DESIGN SURFACE LEVEL			405.369	404.347																
NATURAL SURFACE LEVEL			405.369	404.347																
DESIGN OFFSET			-7.542	-5.500																

CH 63850

CENTRELINE SETOUT
E 240370.668
N 7201356.956
RL 406.738

DATUM RL 404.0

DESIGN SURFACE LEVEL			407.115	406.133																
NATURAL SURFACE LEVEL			407.115	406.133																
DESIGN OFFSET			-7.463	-5.500																

CH 63800

CENTRELINE SETOUT
E 240347.134
N 7201401.072
RL 408.509

DATUM RL 405.0

DESIGN SURFACE LEVEL			408.386	407.904																
NATURAL SURFACE LEVEL			408.386	407.904																
DESIGN OFFSET			-6.464	-5.500																

CH 63750

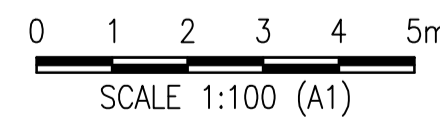

No.	Description	Reviewed	Approved	Date
1	TENDER ISSUE	-	-	23/08/2024



Client	BANANA SHIRE COUNCIL
Project	DEFENCE ROAD UPGRADE - CH 36,172 - CH68,499
Title	ANNOTATED CROSS SECTIONS SHEET 55 OF 64

Drawn	MS	Designed	MS	Approved	
Drawing Check		Design Check		RPEQ	Date

Scale (A1 size)	1:100
Drawing is not to be used for construction unless approved.	



51 Sheridan Street
Cairns Qld 4870
T (07) 4281 6897
E admin@arindustries.com.au
W www.arindustries.com.au
ABN: 49 641 461 298

TENDER ISSUE ONLY

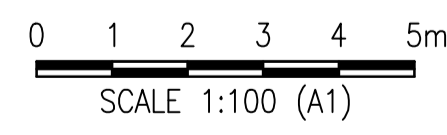
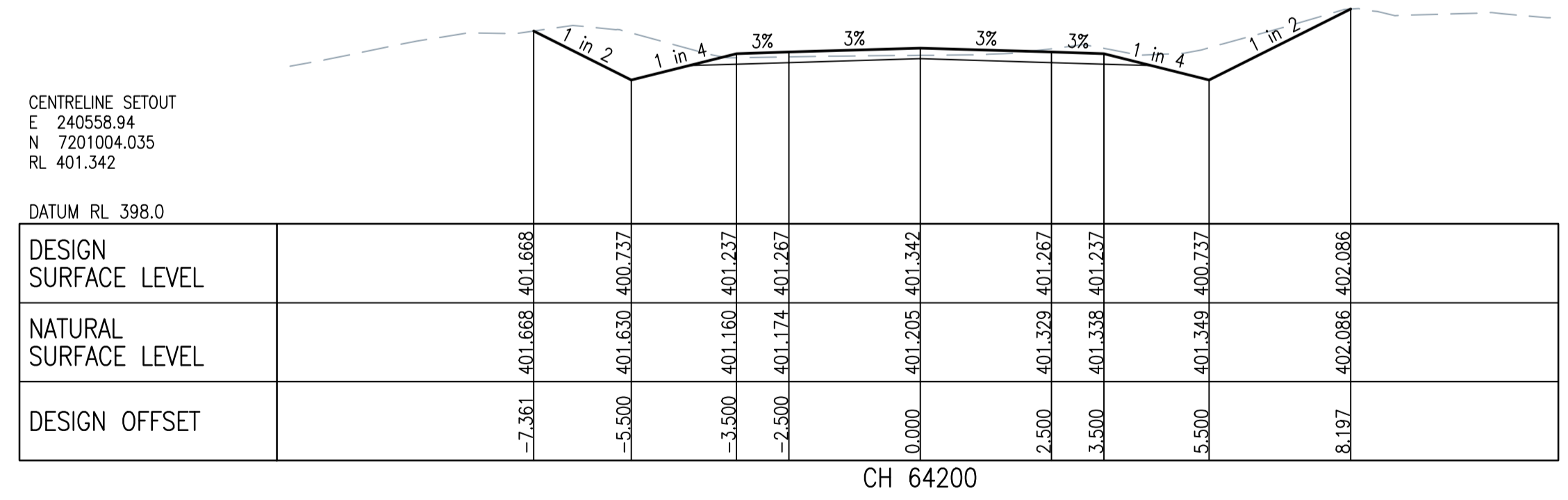
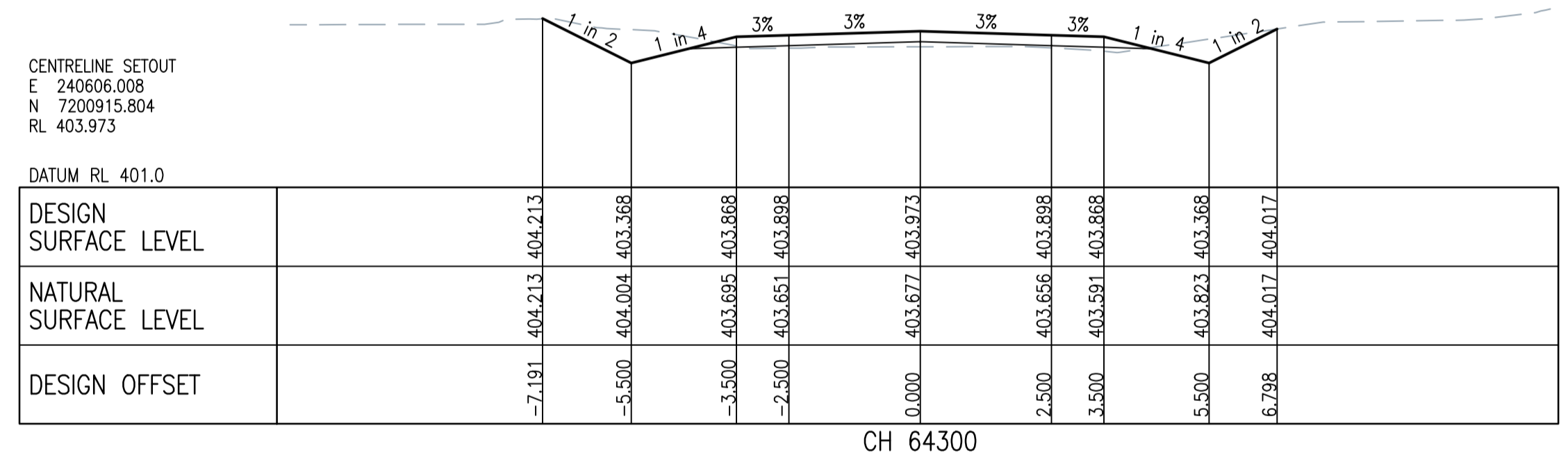
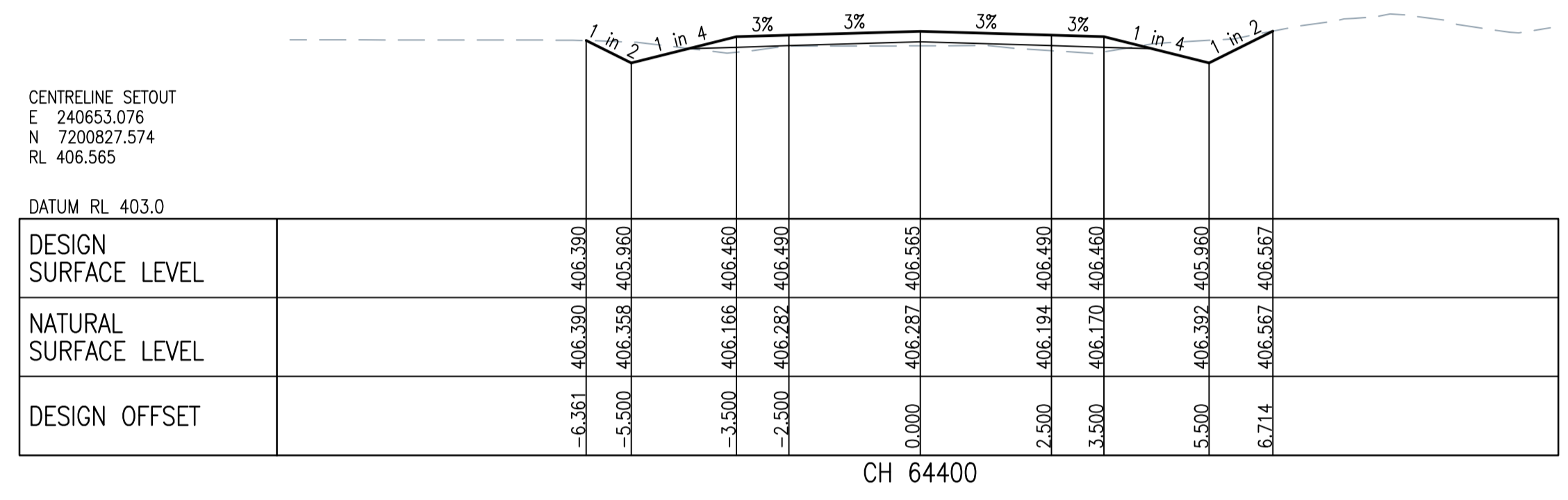
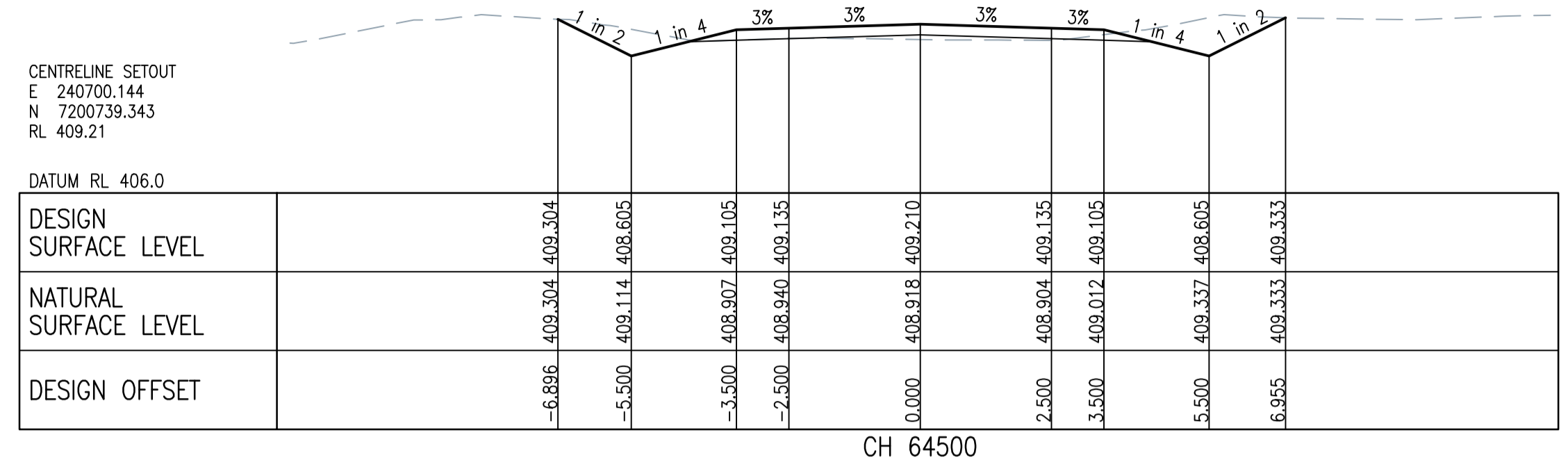
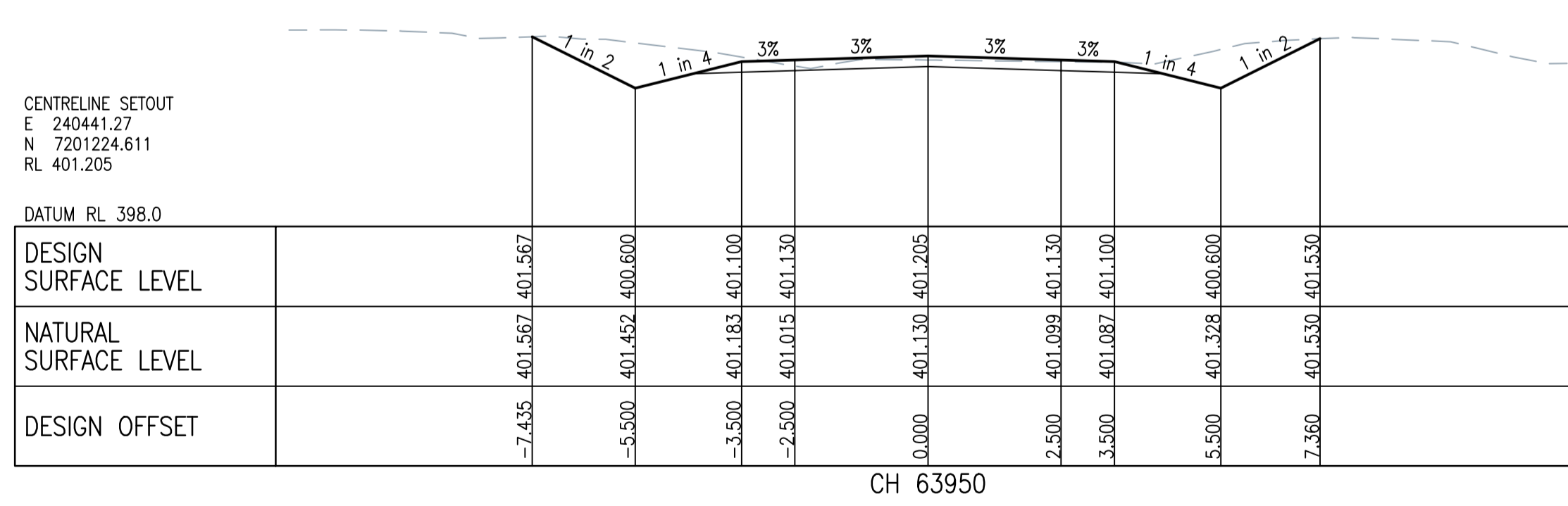
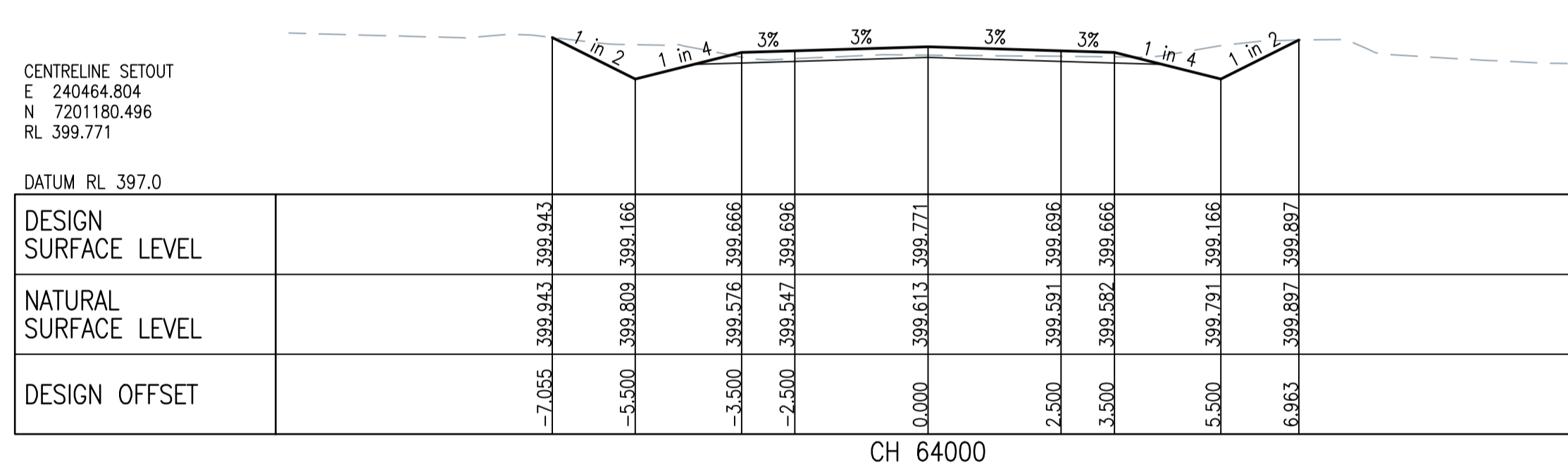
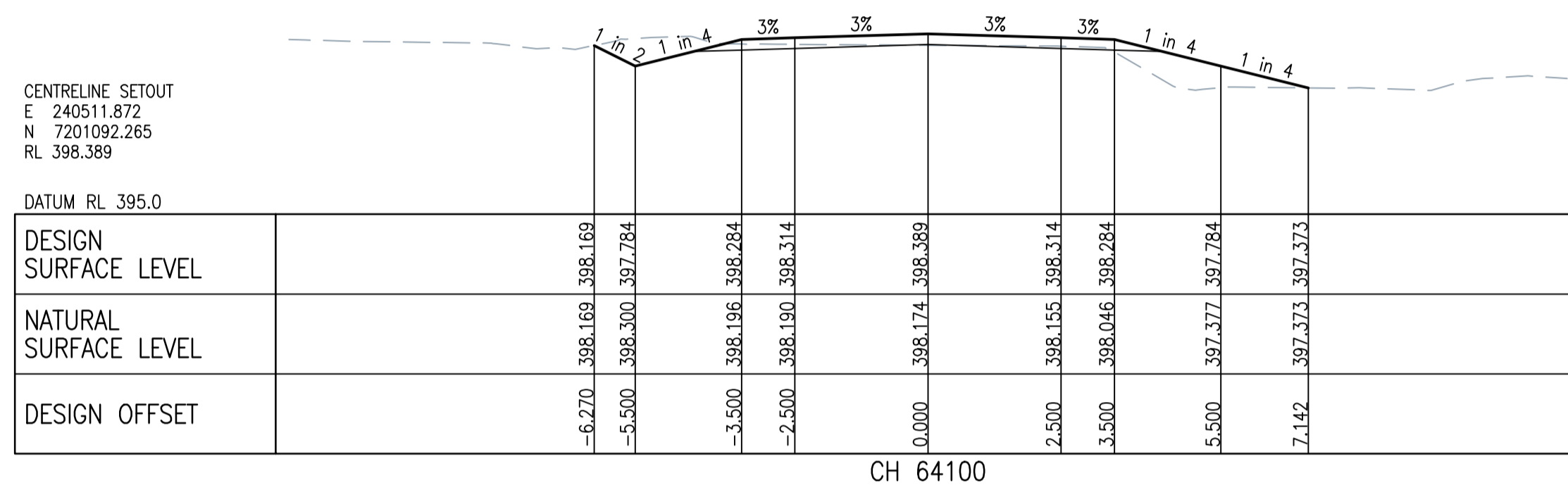
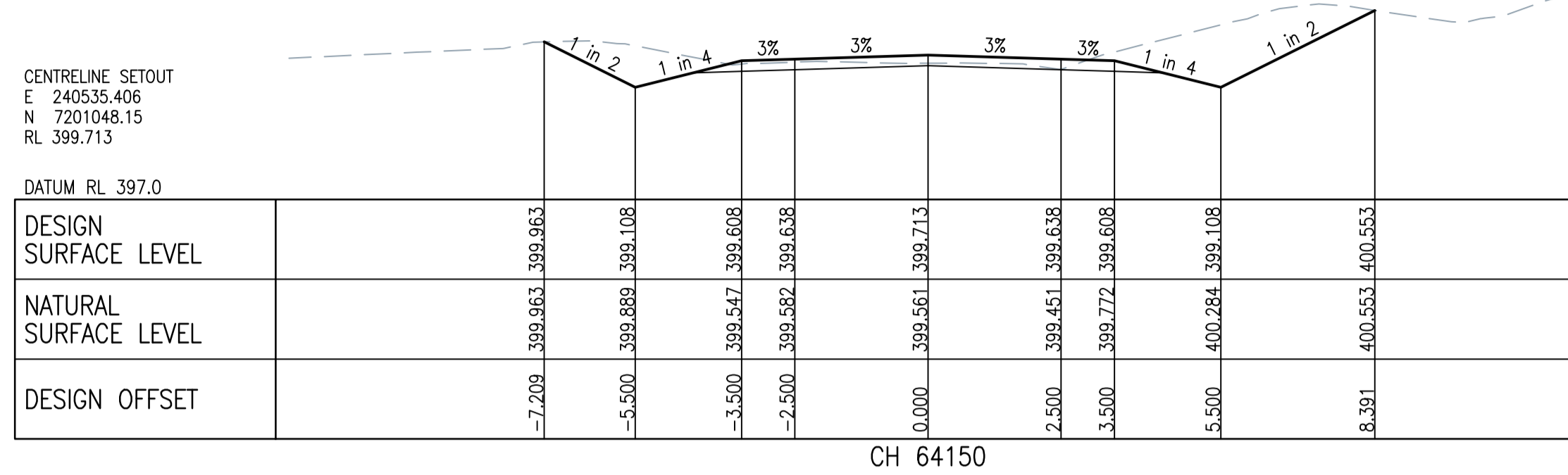

No.	Description	Reviewed	Approved	Date
1	TENDER ISSUE	-	-	23/08/2024



Client: BANANA SHIRE COUNCIL
Project: DEFENCE ROAD UPGRADE - CH 36,172 - CH68,499
Title: ANNOTATED CROSS SECTIONS SHEET 56 OF 64
Drawing No. ARO0400-C105

Drawn	Designed	Approved	Scale (A1 size)
MS	MS		1:100
Drawing Check	Design Check	RPEQ	Date

Drawing is not to be used for construction unless approved.

TENDER ISSUE ONLY

51 Sheridan Street
Cairns Qld 4870
T (07) 4281 6897
E admin@arindustries.com.au
W www.arindustries.com.au
ABN: 49 641 461 298

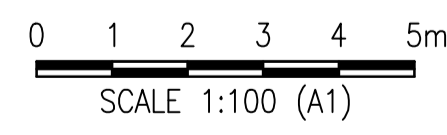
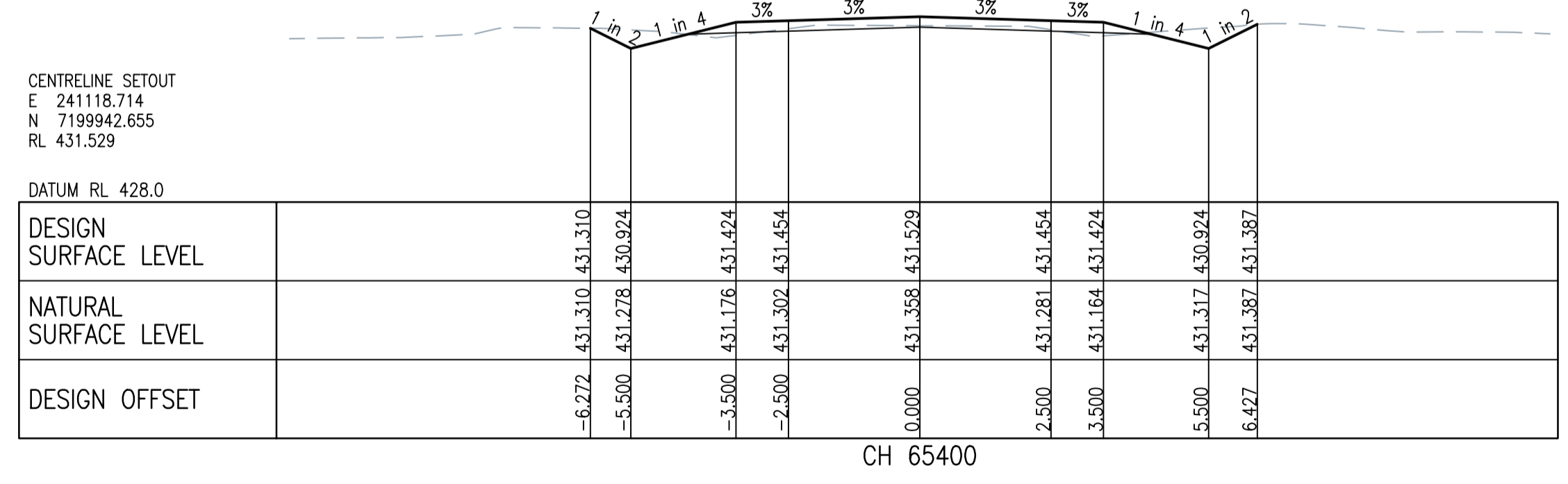
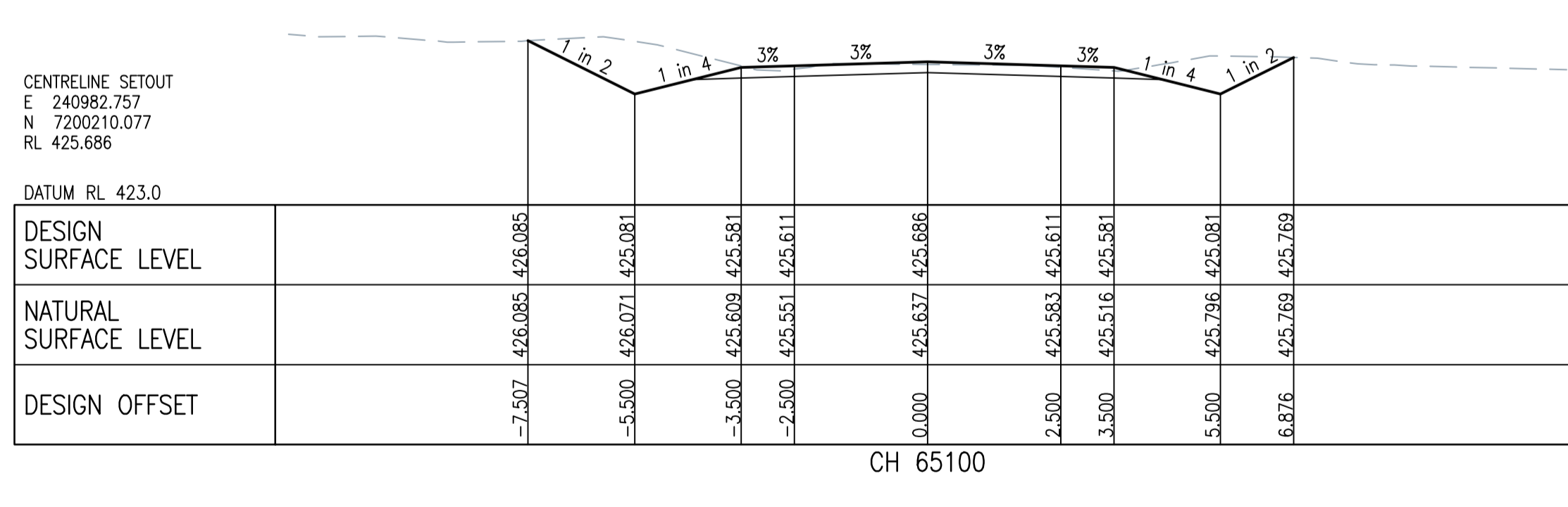
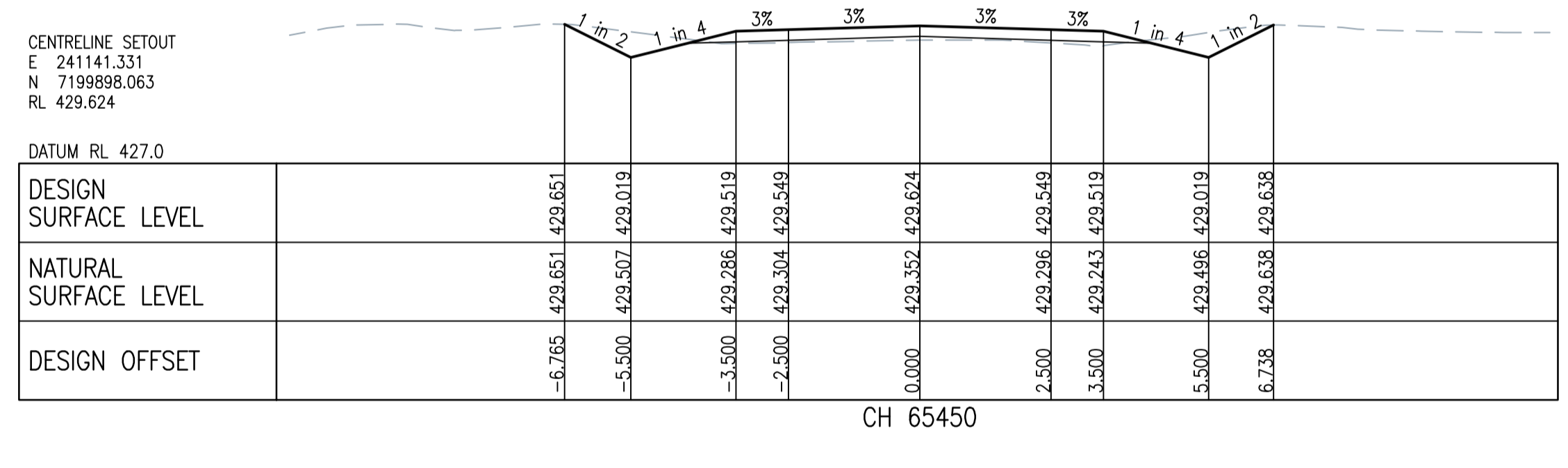
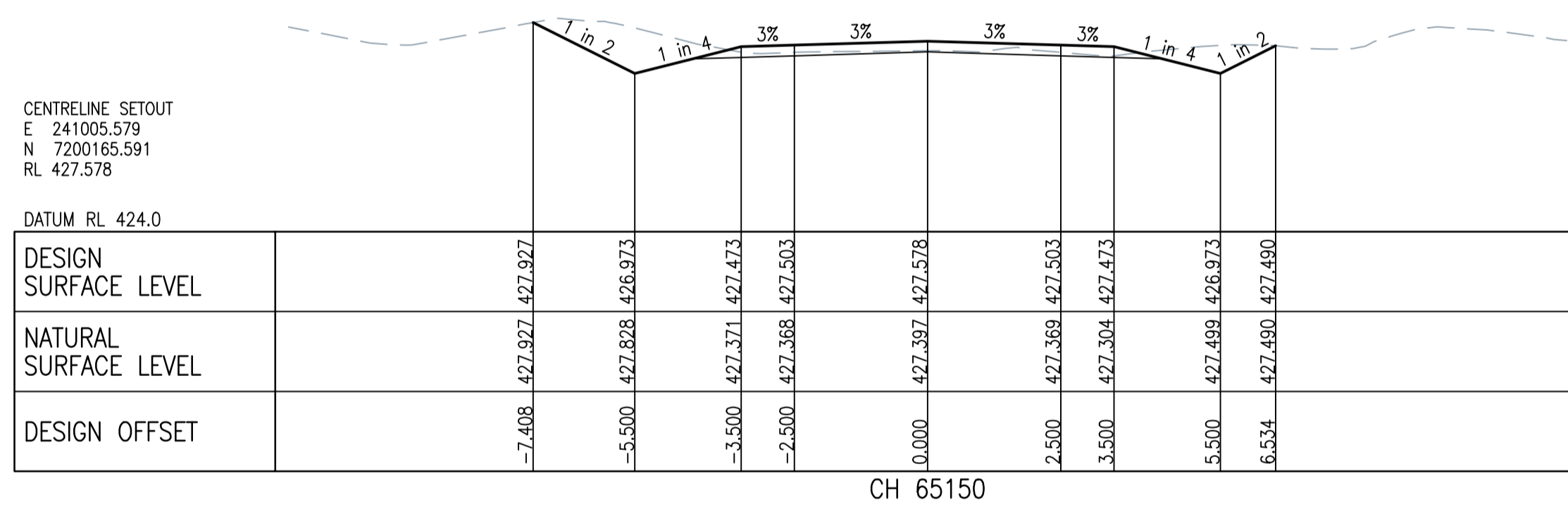
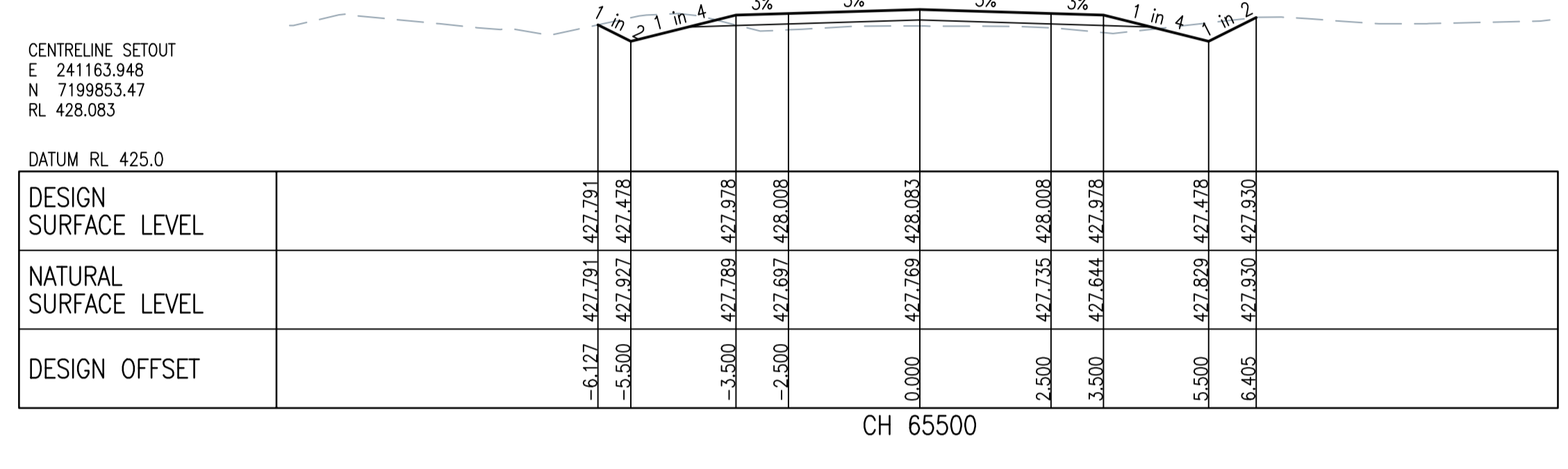
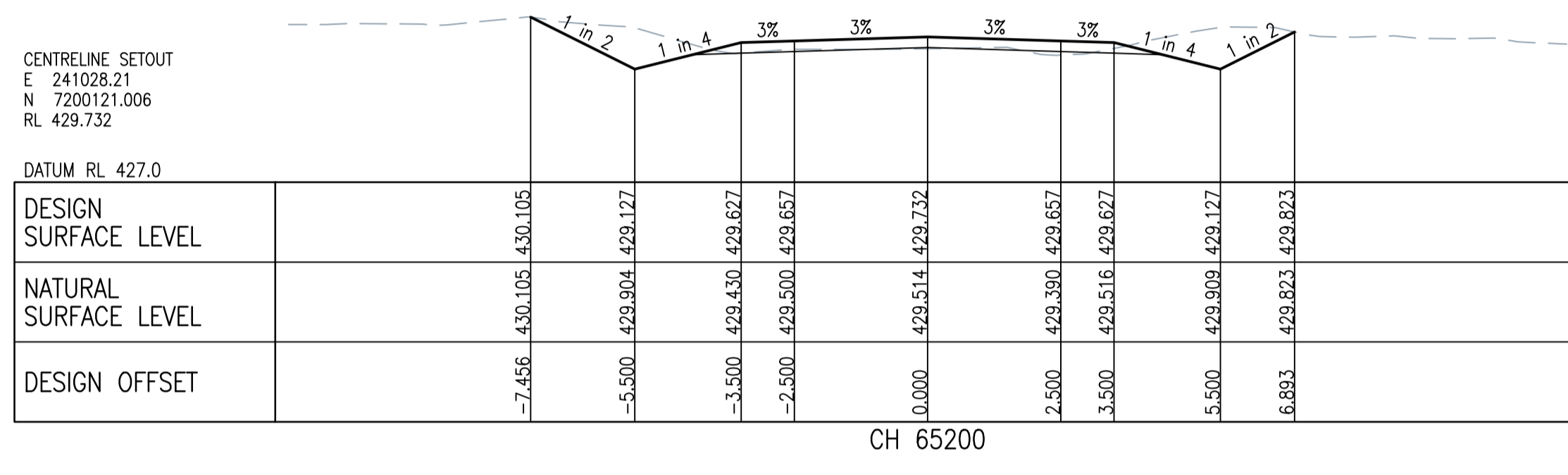
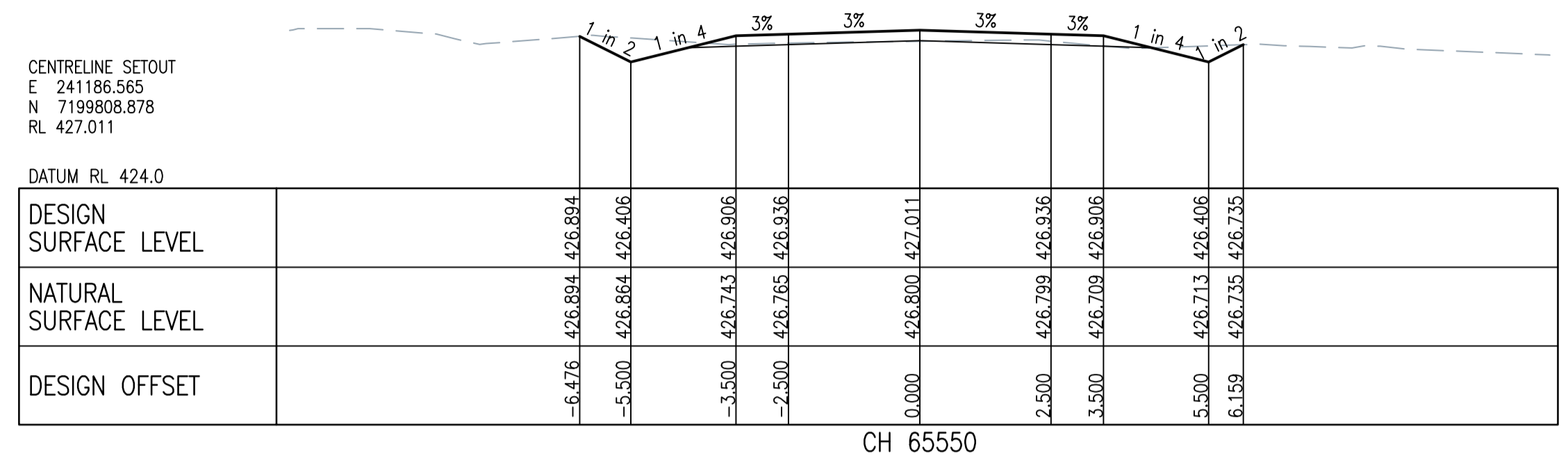
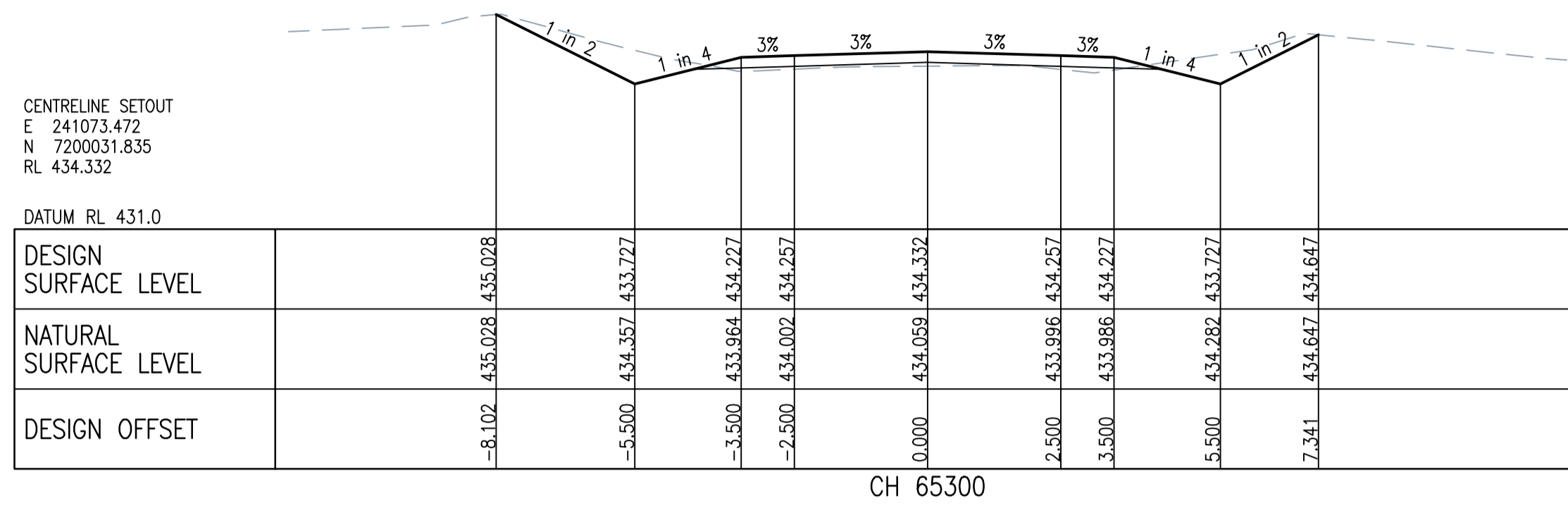

No.	Description	Reviewed	Approved	Date
1	TENDER ISSUE	-	-	23/08/2024



Client: BANANA SHIRE COUNCIL
 Project: DEFENCE ROAD UPGRADE - CH 36,172 - CH68,499
 Title: ANNOTATED CROSS SECTIONS SHEET 58 OF 64
 Drawing No. ARO0400-C107

Drawn: MS	Designed: MS	Approved: RPEQ	Date:
-----------	--------------	----------------	-------

Scale (A1 size): 1:100
 Drawing is not to be used for construction unless approved.



51 Sheridan Street
 Cairns Qld 4870
 T (07) 4281 6897
 E admin@arindustries.com.au
 W www.arindustries.com.au
 ABN: 49 641 461 298

TENDER ISSUE ONLY

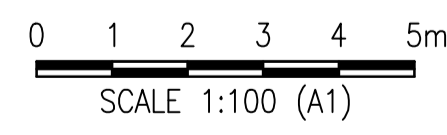
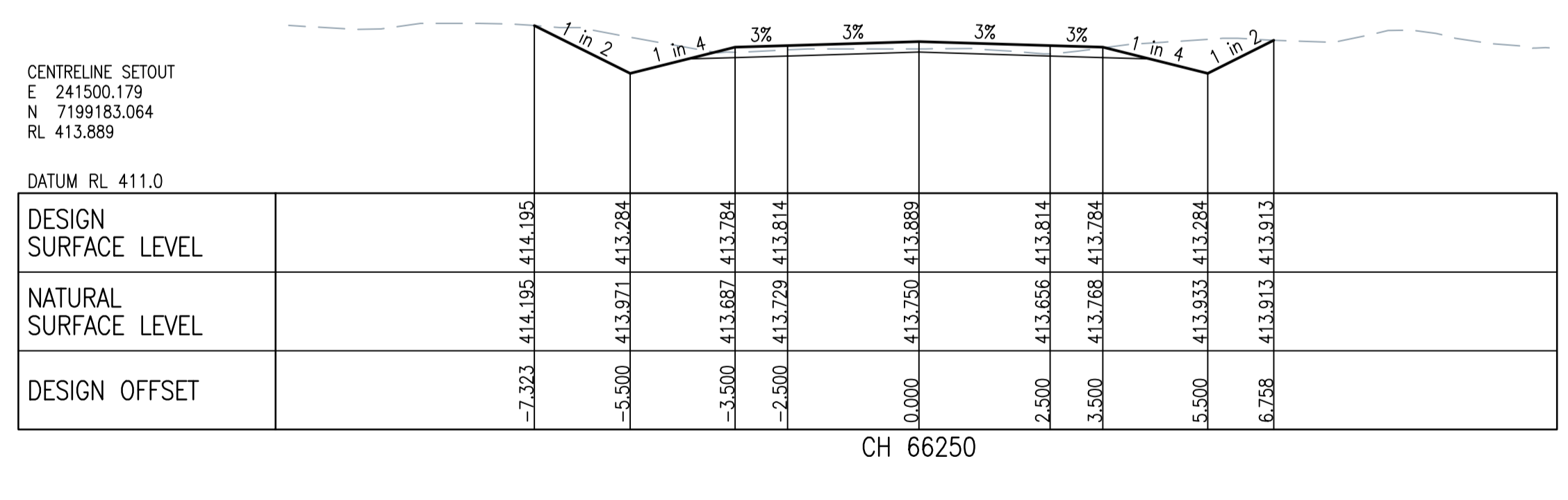
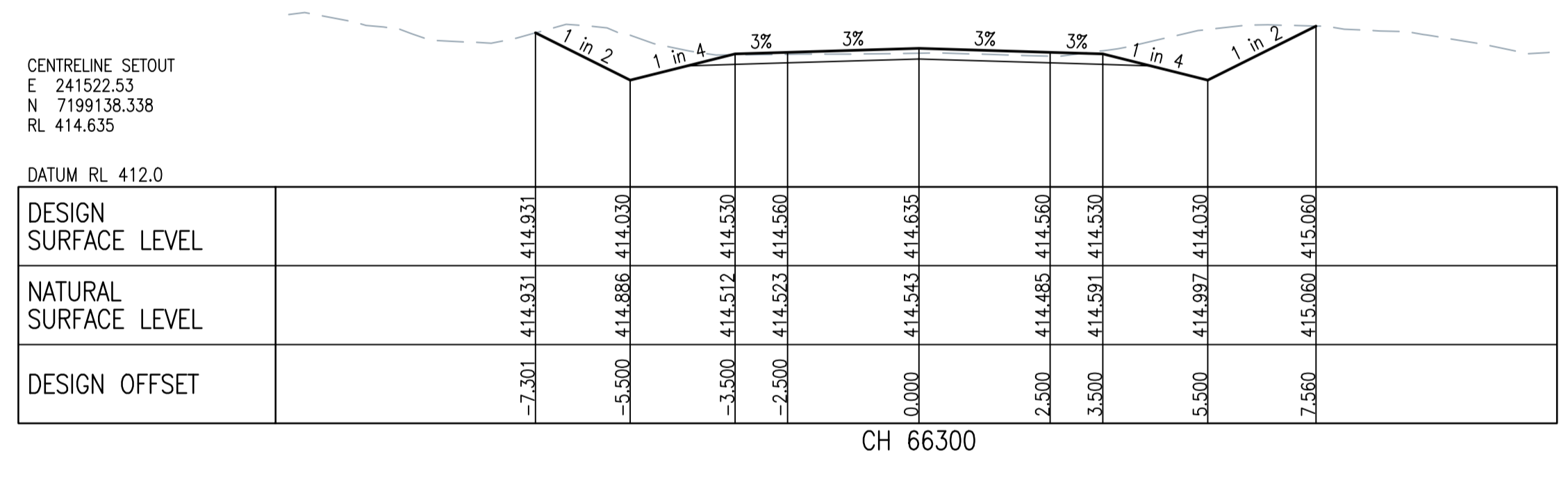
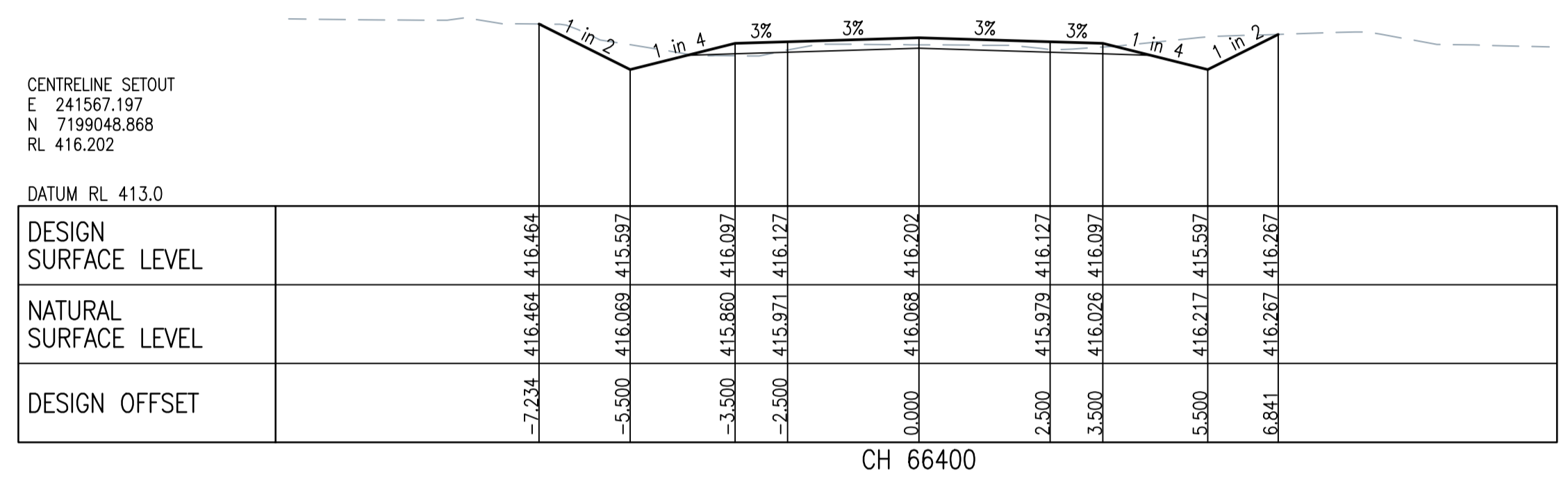
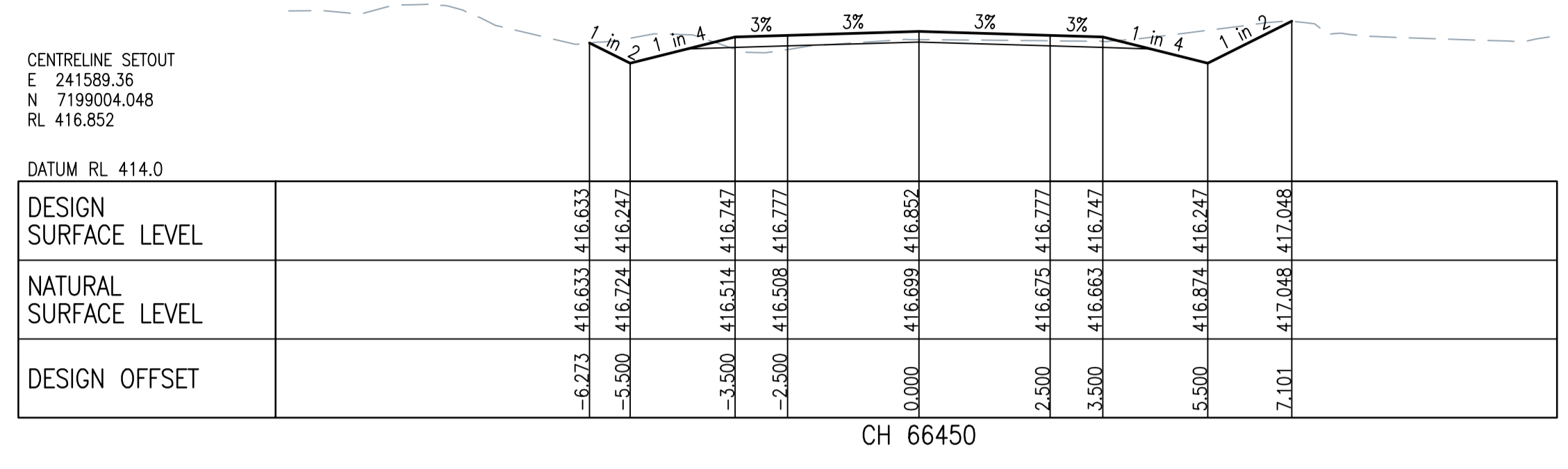
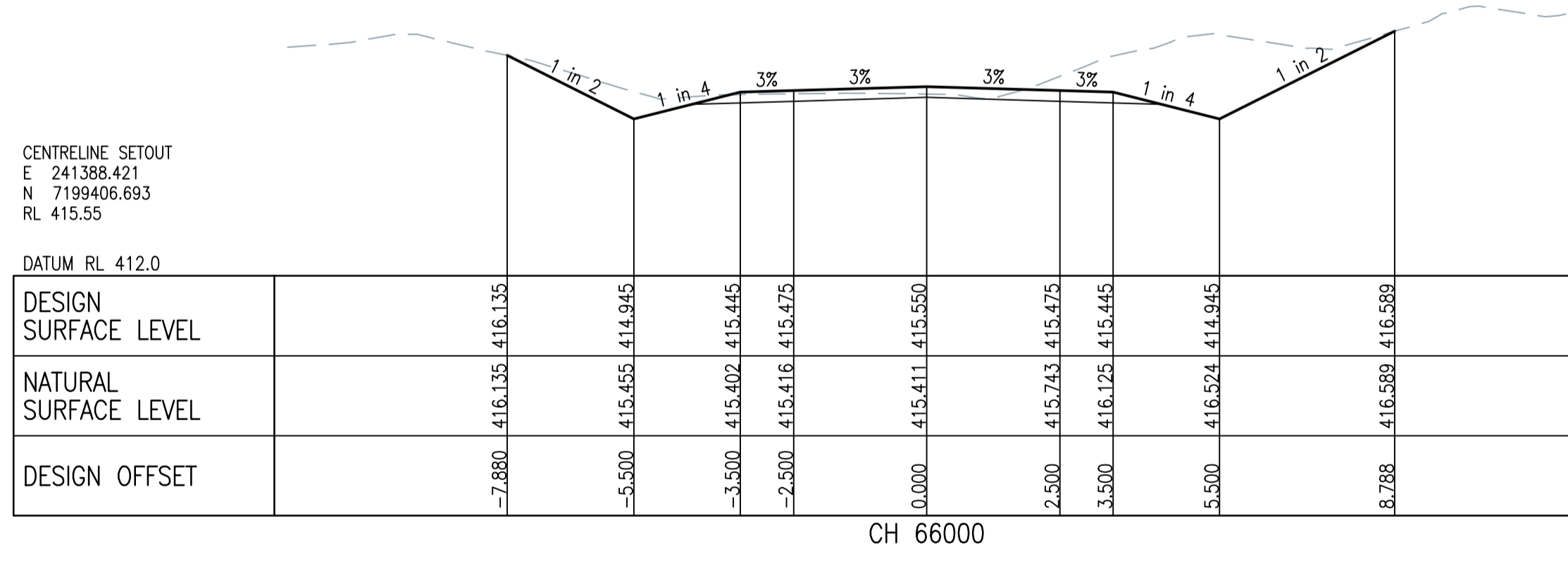
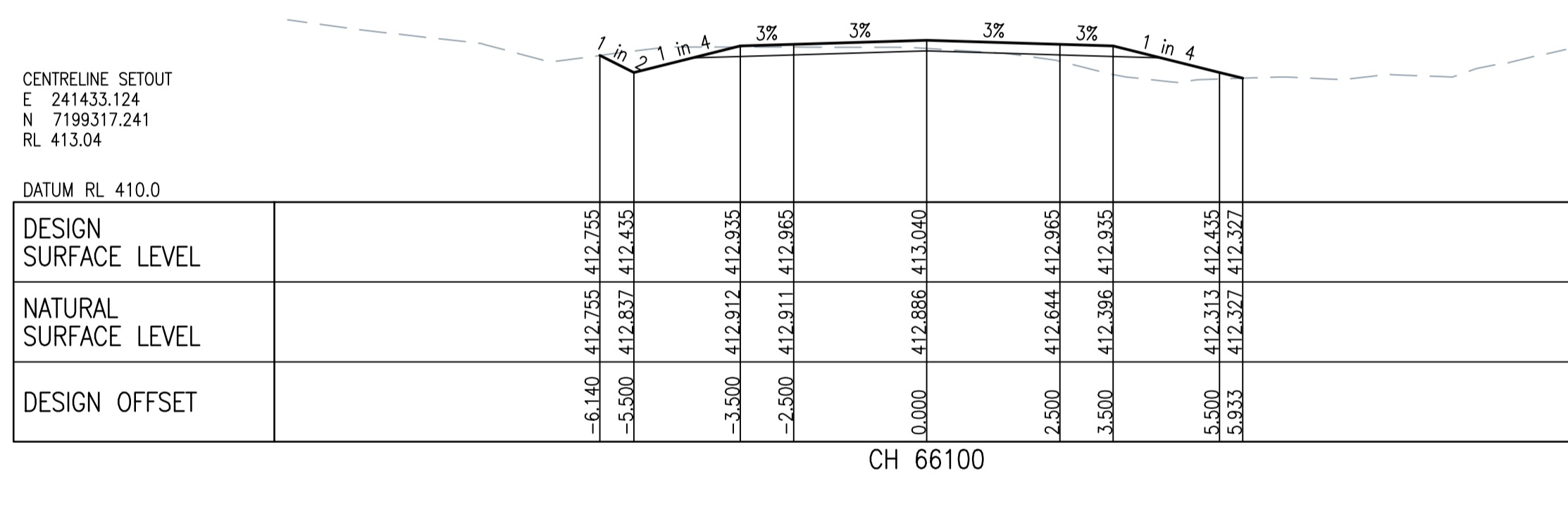
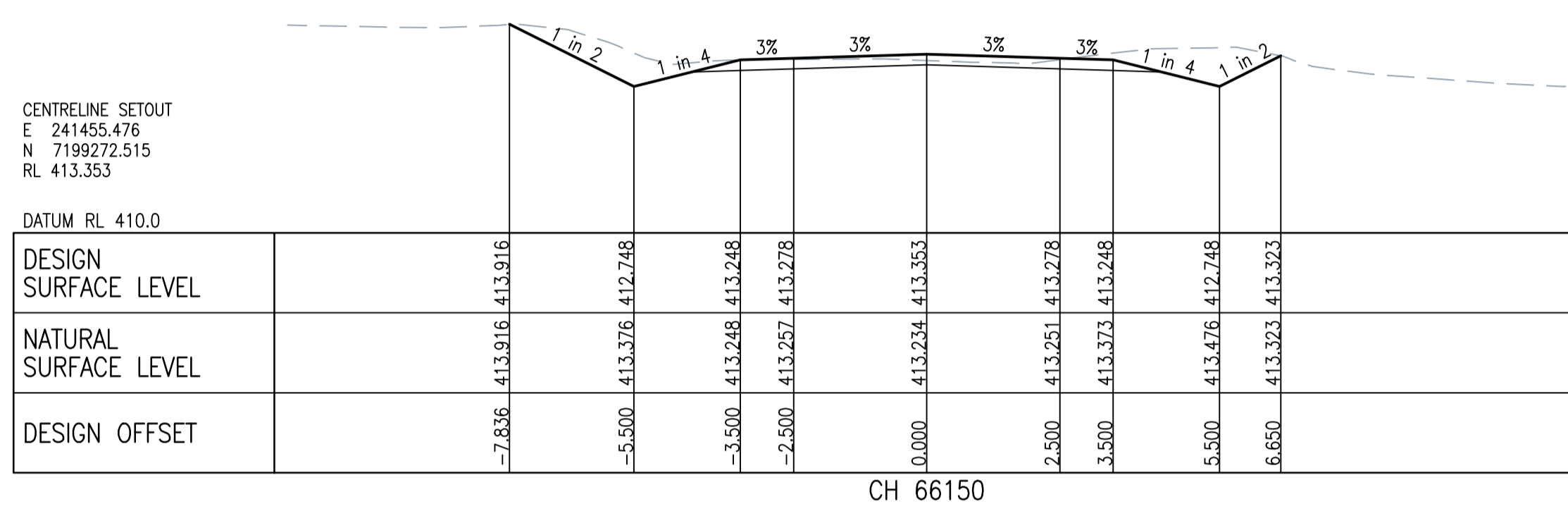
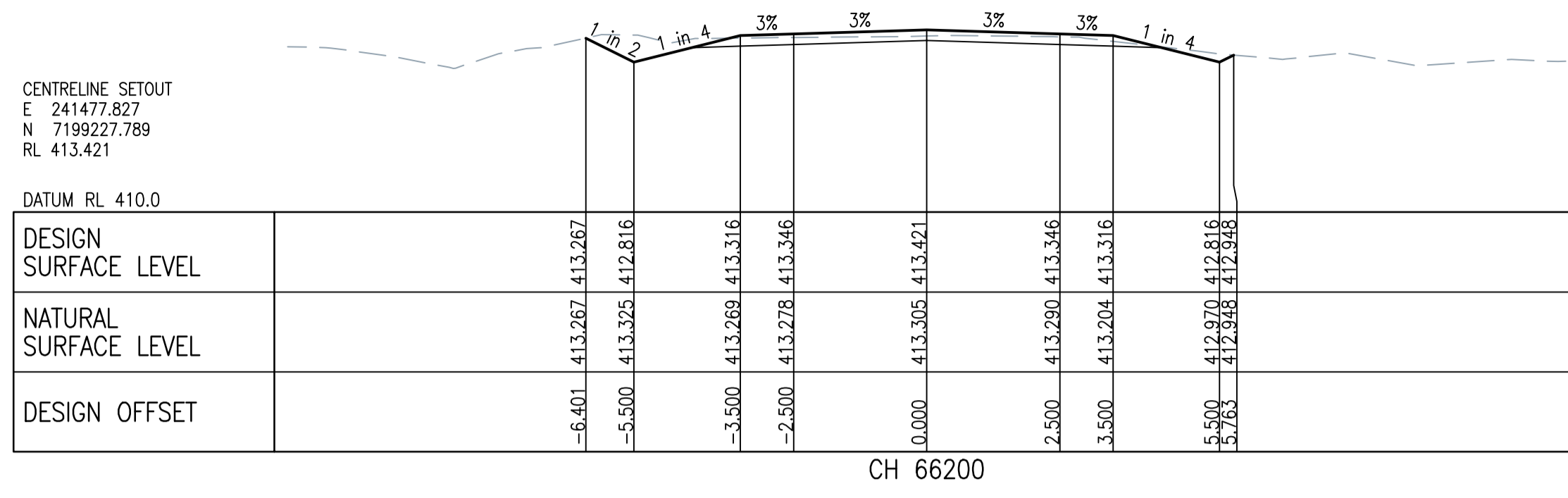

No.	Description	Reviewed	Approved	Date
1	TENDER ISSUE	-	-	23/08/2024



Client	BANANA SHIRE COUNCIL
Project	DEFENCE ROAD UPGRADE - CH 36,172 - CH68,499
Title	ANNOTATED CROSS SECTIONS SHEET 60 OF 64
Drawing No.	ARO0400-C109

Drawn	MS	Designed	MS	Approved		Scale (A1 size)	1:100
Drawing Check		Design Check		RPEQ	Date	Drawing is not to be used for construction unless approved.	

TENDER ISSUE ONLY

51 Sheridan Street
Cairns Qld 4870
T (07) 4281 6897
E admin@aroindustries.com.au
W www.aroindustries.com.au
ABN: 49 641 461 298

CENTRELINE SETOUT
E 241678.012
N 7198824.77
RL 418.832

DATUM RL 416.0	
DESIGN SURFACE LEVEL	419.153 418.227 418.727 418.757 418.832 418.757 418.727 418.918 418.952
NATURAL SURFACE LEVEL	419.153 419.033 418.643 418.637 418.690 418.639 418.639 418.918 418.952
DESIGN OFFSET	-7.351 -5.500 -3.500 -2.500 0.000 2.500 3.500 5.500 6.949

CH 66650

CENTRELINE SETOUT
E 241655.849
N 7198869.589
RL 418.227

DATUM RL 415.0	
DESIGN SURFACE LEVEL	418.487 417.622 418.122 418.152 418.227 418.152 418.122 418.207
NATURAL SURFACE LEVEL	418.487 418.333 418.019 417.982 418.057 417.975 417.984 418.207
DESIGN OFFSET	-7.228 -5.500 -3.500 -2.500 0.000 2.500 3.500 5.500 6.670

CH 66600

CENTRELINE SETOUT
E 241633.686
N 7198914.409
RL 417.713

DATUM RL 415.0	
DESIGN SURFACE LEVEL	418.022 417.108 417.608 417.638 417.713 417.638 417.608 417.638
NATURAL SURFACE LEVEL	418.022 417.762 417.553 417.512 417.504 417.479 417.413 417.638
DESIGN OFFSET	-7.329 -5.500 -3.500 -2.500 0.000 2.500 3.500 5.500 6.560

CH 66550

CENTRELINE SETOUT
E 241611.523
N 7198959.228
RL 417.306

DATUM RL 414.0	
DESIGN SURFACE LEVEL	417.582 416.701 417.201 417.231 417.306 417.231 417.201 417.393
NATURAL SURFACE LEVEL	417.582 417.341 417.118 417.081 417.213 417.144 417.109 417.393
DESIGN OFFSET	-7.263 -5.500 -3.500 -2.500 0.000 2.500 3.500 5.500 6.865

CH 66500

CENTRELINE SETOUT
E 241788.341
N 7198600.434
RL 418.128

DATUM RL 415.0	
DESIGN SURFACE LEVEL	418.685 417.523 418.023 418.053 418.128 418.053 418.023 418.483
NATURAL SURFACE LEVEL	418.685 418.135 417.818 417.864 417.978 417.895 418.239 418.483
DESIGN OFFSET	-7.825 -5.500 -3.500 -2.500 0.000 2.500 3.500 5.500 7.420

CH 66900

CENTRELINE SETOUT
E 241766.645
N 7198645.481
RL 417.506

DATUM RL 413.0	
DESIGN SURFACE LEVEL	415.527 416.901 417.401 417.431 417.506 417.431 417.401 415.874
NATURAL SURFACE LEVEL	415.527 416.228 416.156 417.184 417.257 417.217 416.747 415.874
DESIGN OFFSET	-10.985 -5.500 -3.500 -2.500 0.000 2.500 3.500 5.500 9.608

CH 66850

CENTRELINE SETOUT
E 241744.502
N 7198690.311
RL 417.805

DATUM RL 415.0	
DESIGN SURFACE LEVEL	417.902 417.200 417.700 417.730 417.805 417.730 417.700 417.865
NATURAL SURFACE LEVEL	417.902 418.037 417.637 417.603 417.620 417.485 417.475 417.865
DESIGN OFFSET	-6.904 -5.500 -3.500 -2.500 0.000 2.500 3.500 5.500 6.831

CH 66800

CENTRELINE SETOUT
E 241700.175
N 7198779.95
RL 419.021

DATUM RL 416.0	
DESIGN SURFACE LEVEL	419.334 418.416 418.916 418.946 419.021 418.946 418.916 418.851
NATURAL SURFACE LEVEL	419.334 419.015 418.772 418.828 418.876 418.799 418.731 418.851
DESIGN OFFSET	-7.335 -5.500 -3.500 -2.500 0.000 2.500 3.500 5.500 6.370

CH 66700

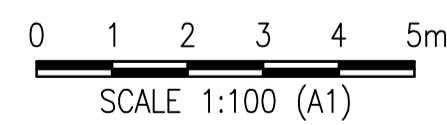

No.	Description	Reviewed	Approved	Date
1	TENDER ISSUE	-	-	23/08/2024



Client	BANANA SHIRE COUNCIL
Project	DEFENCE ROAD UPGRADE - CH 36,172 - CH68,499
Title	ANNOTATED CROSS SECTIONS SHEET 61 OF 64

Drawn	MS	Designed	MS	Approved	
Drawing Check		Design Check		RPEQ	Date

Scale (A1 size)
1:100

Drawing is not to be used for construction unless approved.

51 Sheridan Street
Cairns Qld 4870
T (07) 4281 6897
E admin@aroindustries.com.au
W www.aroindustries.com.au
ABN: 49 641 461 298

TENDER ISSUE ONLY

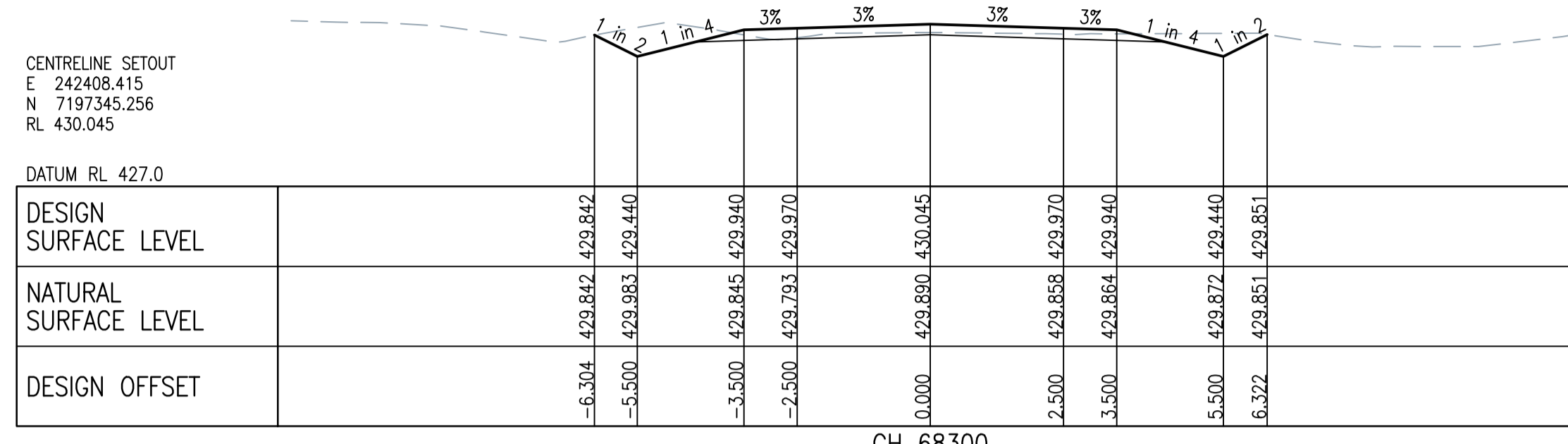

CH 68300

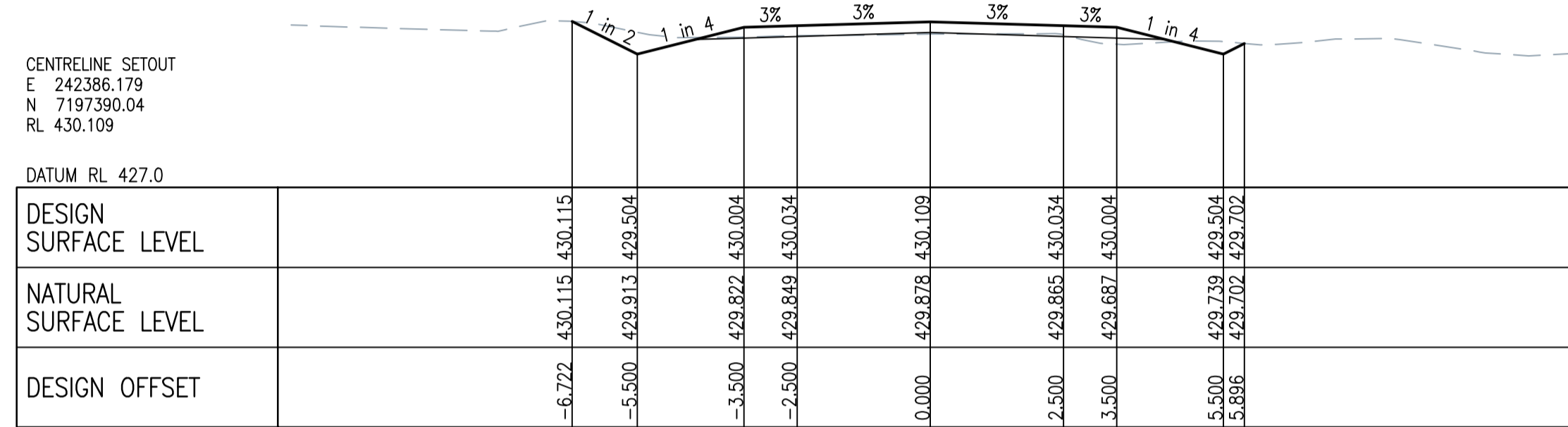

CH 68250

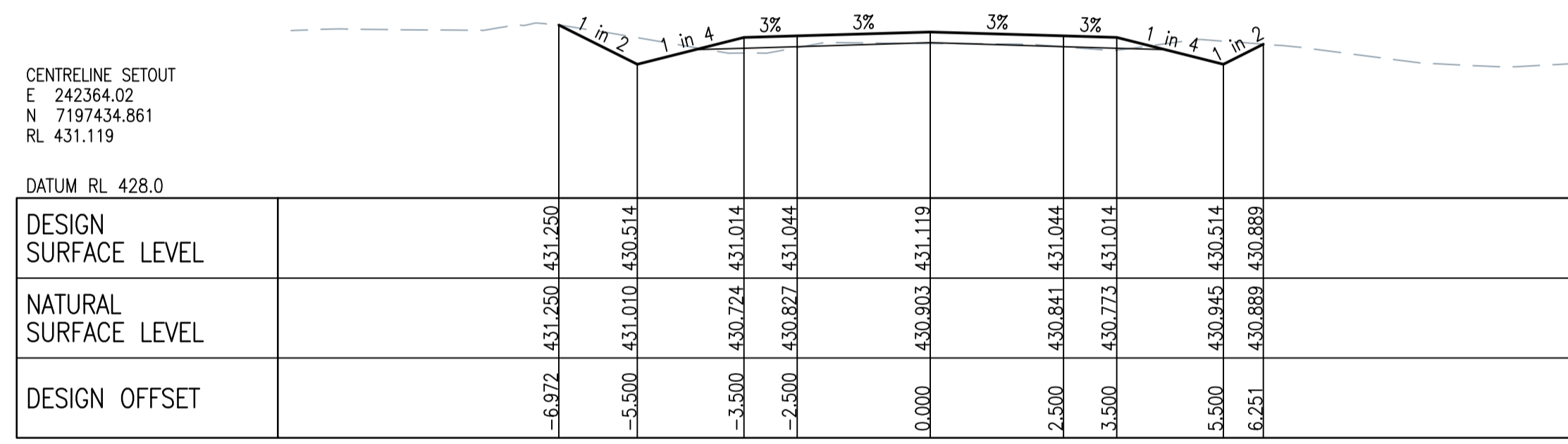

CH 68200

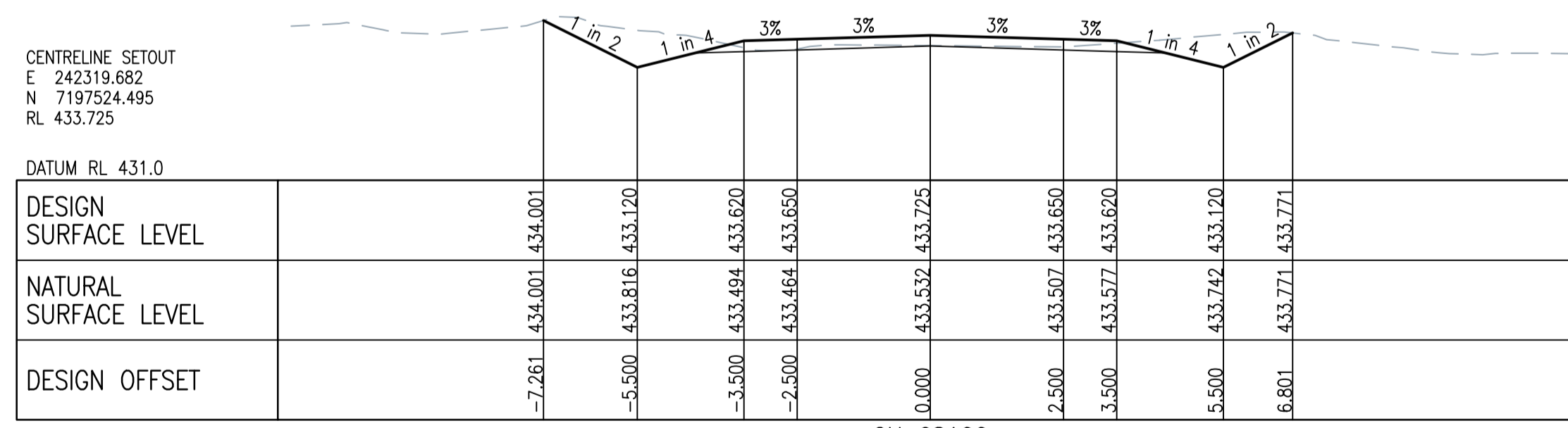

CH 68100

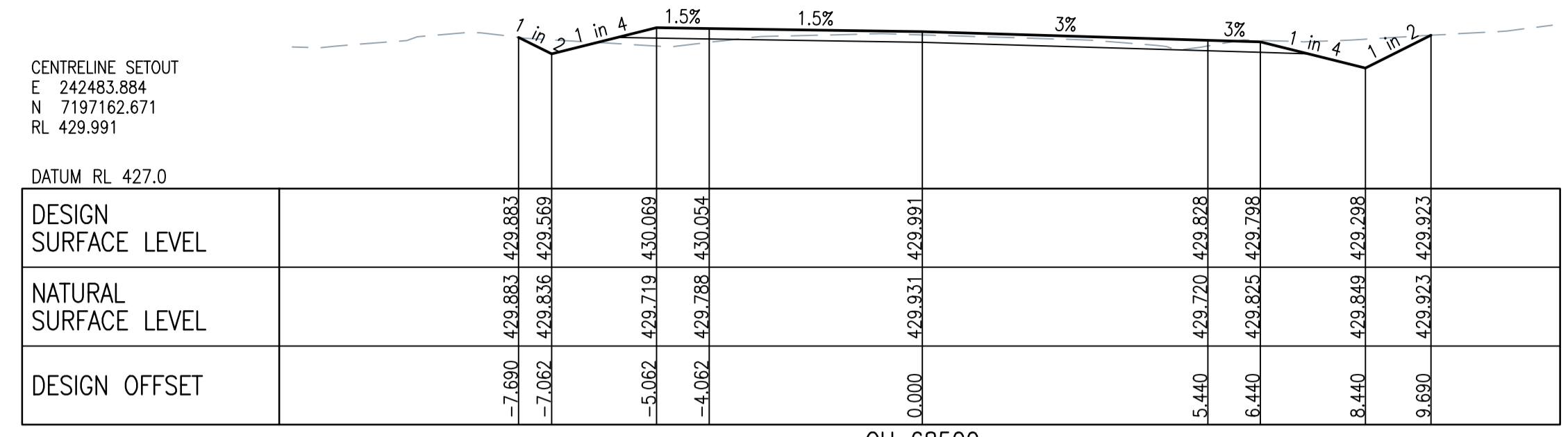

CH 68500

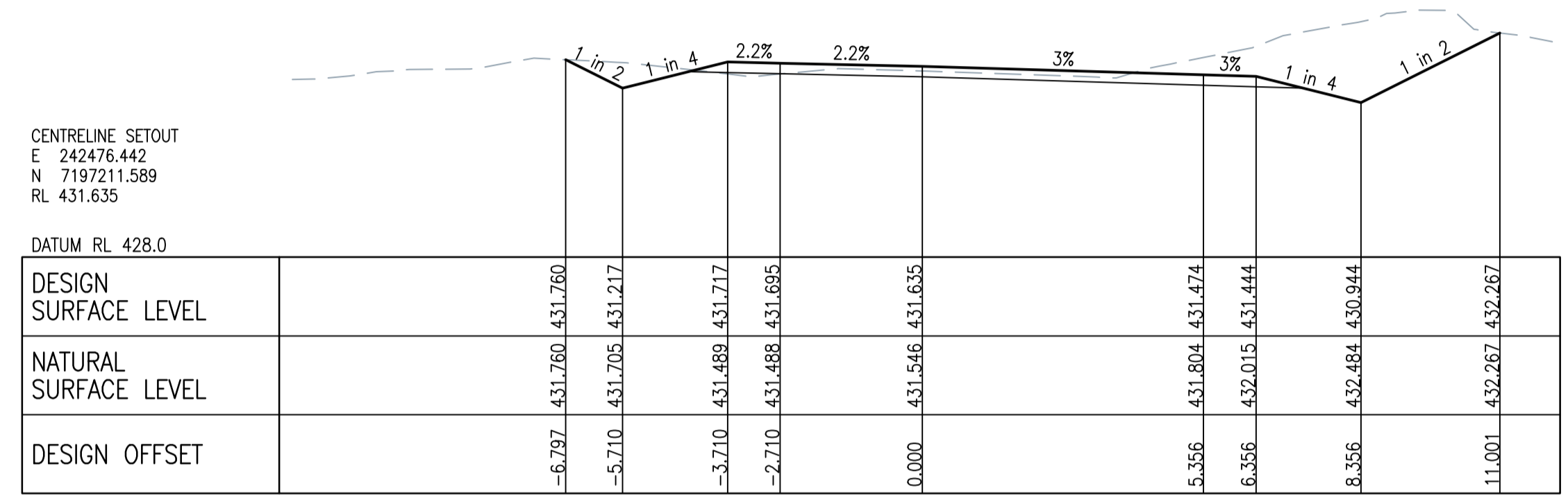

CH 68450

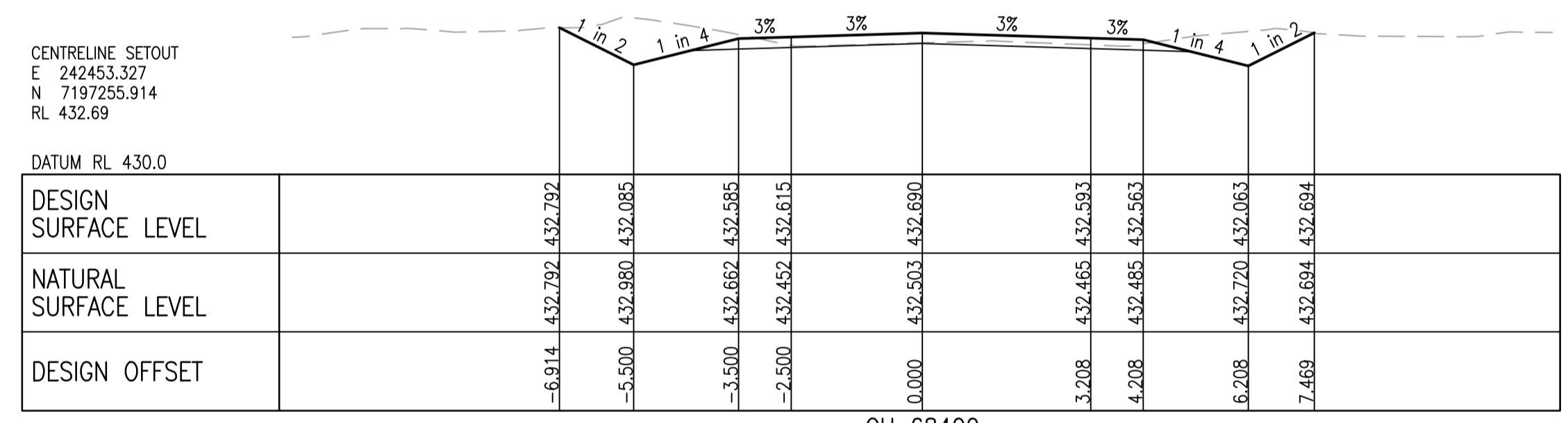

CH 68400

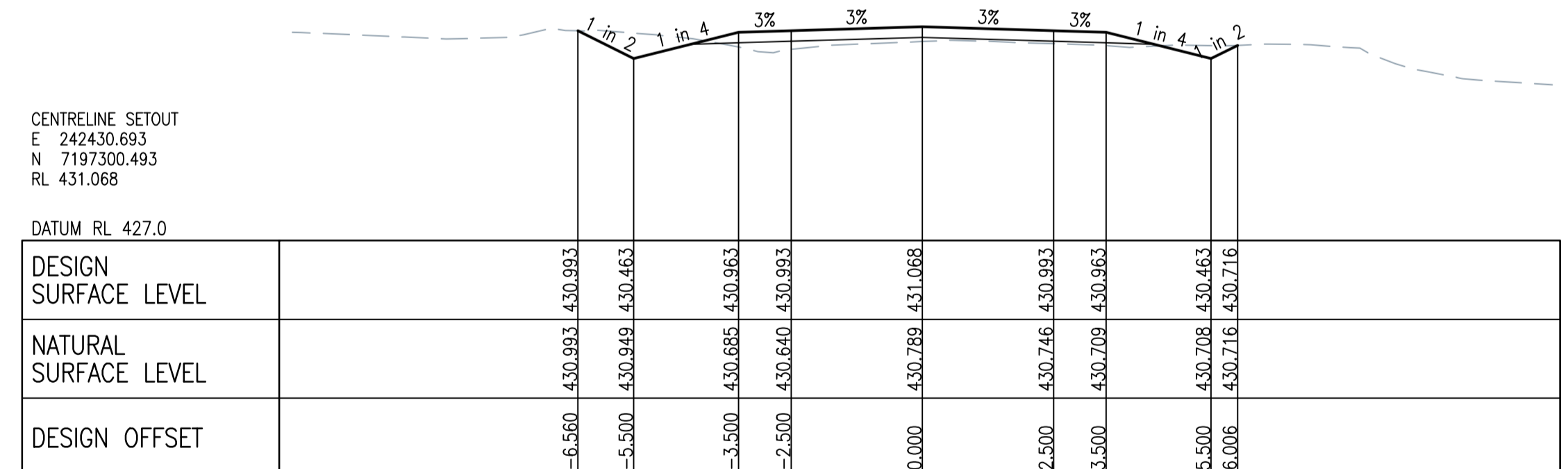

CH 68350

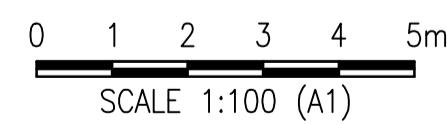

TENDER ISSUE ONLY

No.	Description	Reviewed	Approved	Date
1	TENDER ISSUE	-	-	23/08/2024



Client	BANANA SHIRE COUNCIL
Project	DEFENCE ROAD UPGRADE - CH 36,172 - CH 68,499
Title	ANNOTATED CROSS SECTIONS SHEET 64 OF 64

Drawn	MS
Designed	MS
Approved	RPEQ
Date	

Scale (A1 size)	1:100
Drawing is not to be used for construction unless approved.	



51 Sheridan Street
Cairns Qld 4870
T (07) 4281 6897
E admin@aroindustries.com.au
W www.aroindustries.com.au
ABN: 49 641 461 298